

A Tale of Two Out-of-Phase Synchronizing Events at BC Hydro

Mukesh Nagpal and Lesley Gu, *BC Hydro*
 Ralph Barone, *Barone Technical Consulting Services Ltd*
 Ritwik Chowdhury and Michael Thompson, *Schweitzer Engineering Laboratories, Inc.*

Abstract—This paper tells the tale of two out-of-phase synchronizing (OOPS) events that occurred at BC Hydro. A generator was synchronized 180 degrees out-of-phase without staff awareness of the faulty synchronization. During testing, the staff suspected a poor synchronization, after which the transient event records were investigated. The investigation concluded that the reference voltage signal was inverted because of a wiring error in the auxiliary voltage transformer (VT) circuit, which provided a common input to the autosynchronizer, synchroscope, and synchronism-check relay.

The 16 kV generator breaker that is normally used to sync-close the unit to the system was equipped with OOPS protection, but the protection was not enabled because the breaker was closed before the event. A 500 kV breaker was used for synchronization; however, it was not equipped with OOPS protection, because the protection was not expected to perform well with high bus current ratings.

During the OOPS event, many elements picked up, but none tripped. For instance, the loss-of-field and current unbalance elements asserted. However, because of their long time delays, these elements did not trip. The out-of-step protection qualified this disturbance as an event that did not cause an unstable power swing. The protection performed as designed, but it did not indicate poor synchronization.

This paper provides an analysis of the different generator protection elements and discusses considerations for dedicated OOPS alarming and protection. This paper also discusses the follow-up diagnostics that were performed and provides recommendations to prevent the occurrence of a future OOPS event.

I. INTRODUCTION

An out-of-phase synchronizing (OOPS) event can cause significant torsional stress to a generator shaft and the prime mover. The generator current that is the result of an OOPS event can exceed the magnitude of the current from a three-phase fault that occurs at the generator terminals, whereas IEEE Std C50.12 and IEEE Std C50.13 require a generator to withstand a three-phase fault at its terminals [1] [2].

This paper tells the tale of the circumstances that led to two 180-degree OOPS events on a hydro generator. Section II of the paper describes these circumstances. The event records retrieved from the generator relay are then analyzed in Section III. Generator protection functions that are commonly applied are not designed to detect an OOPS condition; therefore, these functions provide very little dependability.

Based on observation of field experiences, OOPS events are sometimes cleared because of a fortunate misoperation of a differential relay. On the other hand, OOPS events can remain undetected and uncleared, which can lead to subsequent events that occur without the knowledge of the system's operators. OOPS events are more common than many of the other conditions for which generator protection is typically provided.

A dedicated, built-for-purpose OOPS scheme that alarms or trips selectively for the condition is discussed in Section IV. This scheme has been used by BC Hydro for at least 20 years; it has also been used by another utility for more than 10 years [3] to trip their generators.

The BC Hydro OOPS protection scheme is armed only when the generator is synchronized using a 16 kV unit breaker. The two synchronizing operations discussed in this paper were performed across a 500 kV breaker; therefore, the breaker was not equipped with OOPS protection. This 500 kV breaker was part of a ring-bus system configuration, and the high-voltage (HV) bus current ratings presented a security concern for OOPS protection.

After the OOPS events occurred, it became evident that dedicated protection might have been beneficial to limit stress on the generator and, at the very least, to prevent the second OOPS event. This paper discusses improvements to the OOPS scheme that improve dependability while maintaining security in certain applications in Section IV.C. The discussion includes consideration of the possibility of a breaker failure happening because of delayed current zero-crossings when an HV breaker is tripped.

In the aftermath of the OOPS events, extensive diagnostic testing was performed. This testing is detailed in Section V. The testing concluded that the equipment was not damaged. However, any loss of life to the equipment could not be quantified. This paper concludes by making recommendations that can help mitigate common-mode failures and can also help with the verification of synchronizing circuits.

II. A TALE OF TWO OOPS EVENTS

Generator G3 was on an outage so that the generator step-up transformer (GSU) T3 could be replaced, and the unit protection and control panels could be modernized.

The simplified generation station ac one-line diagram is shown in Fig. 1. Fig. 1 also illustrates the secondary circuit that is used by the G3 synchronizing system. Generator G3 is primarily synchronized across a 16 kV unit breaker (16CB3), but synchronization can also be performed across a 500 kV breaker (5CB6 or 5CB7) as backup control when the primary synchronization is not available. In the 500 kV breaker (backup) synchronizing circuit, a 1:1 auxiliary voltage transformer (VT) is provided for isolation of the ground reference between the yard and the synchronizing panel. Because this auxiliary VT was replaced and reconnected during the unit modernization, functional testing of the 500 kV breaker sync-close was required.

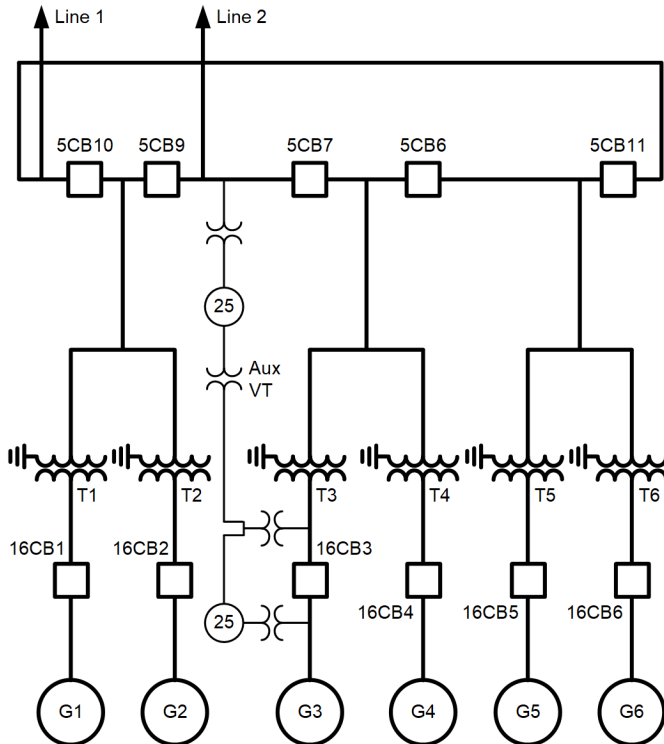

Fig. 1. Simplified one-line diagram of generating plant on ring bus.

On December 3, 2021, the G3 commissioning crew was completing the commissioning task, “5CB7 Sync Closing By G3.” At the time of 5CB7 switching, G1 was generating approximately 385 MW. G2 and G4 were offline. G5 was generating approximately 106 MW, and G6 was operating in synchronous condenser mode. 5CB7 and 5CB6 were open.

The unit breaker 16CB3 was closed with the dead unit (G3) and the dead bus (16 kV bus). After G3 was started, the field was flashed, which simultaneously energized T3, T4, and the 500 kV bus section between 5CB6 and 5CB7. Transformer energization in this manner, often called a soft start, avoids causing large magnetizing inrush currents. 5CB7 was then closed using a remote close via a synchronizer supervised by a synchronism-check relay.

Immediately after the switching, G1 tripped offline and was locked out by an external trip from the governor. Action was taken to investigate the G1 trip only, and it was confirmed that part of the G1 governor code was not configured correctly.

This was thought to be the cause for the governor to be susceptible to lockout trip during the 5CB7 switching transient events. There was no trip or unusual alarm from G3 at the time of the switching, which led the commissioning crew to believe that the transient could be because of the synchronizing relay hitting at a bad angle, likely due to some drift in the breaker closing time. Therefore, they did not consider the possibility of full (180-degree) out-of-phase closing.

On the evening of December 7, 2021, the commissioning crew proceeded with a combination test, “T3 Heat Run Test and G3 Synchronization Test via 5CB7.” Prior to 5CB7 switching, G1, G2, and G4 were offline, and G5 and G6 were generating approximately 450 MW.

Because the crew had suspected a large closing angle when the unit was last synchronized using a synchronizer (on December 3), they decided to use manual synchronization with a synchroscope instead, to minimize the transient to the adjacent units. Unknown to the crew, the generator was synchronized out-of-phase a second time, this time, at exactly 180 degrees because of the “perfect” manual synchroscope closing. The significant transient caused the generator to motor, with 105 MW flow into the generator for a few seconds; following that, the generator was ramped up to continue the transformer heat run test. Several generator protection elements picked up, but none tripped. Because the generator relays did not trip, the crew remained unaware of the faulty synchronization, and the transformer heat run testing continued.

After the 30-hour-long T3 Heat Run Test completed, G3 was taken offline. The commissioning crew started to suspect that something had gone wrong, because there should have been minimal transient from the perfect manual closing via synchroscope. However, the transient data measured by the generator relay illustrated the opposite—a disturbance that was well beyond the size of a typical synchronization disturbance, with 232 kA peak current. This event report is shown in Fig. 2.

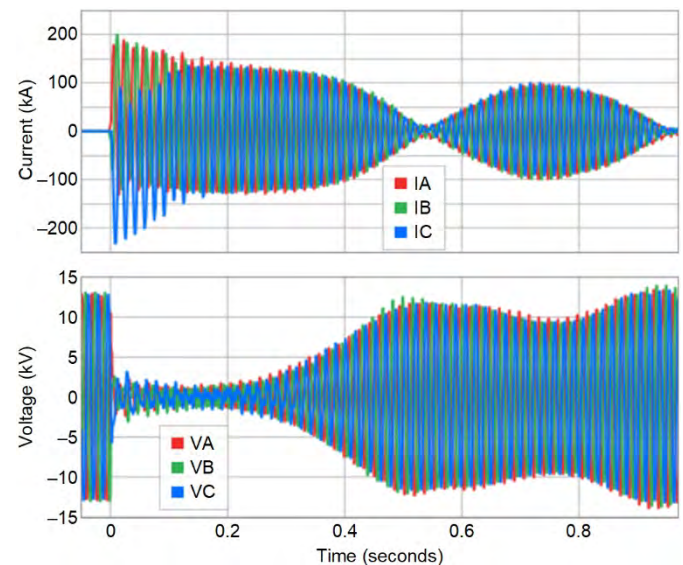

Fig. 2. Second OOPS event (December 7, 2021).

First, the investigation focused on the 500 kV breaker synchronizing circuit, which had been rewired during an

auxiliary VT replacement. It found that the polarities of the VTs had been connected backward. Unfortunately, all three devices (autosynchronizer, synchroscope, and sync-check relays) shared the same auxiliary VT source, which introduced a common-mode failure among all the synchronizing devices and caused them to fail simultaneously. The inverted polarities of the auxiliary VT resulted in a 180-degree OOPS event, despite an ideal synchronizing indication from the synchroscope.

The investigation then focused on why the wiring error occurred in the first place, and why it was not caught during commissioning. Fig. 3a shows the auxiliary wiring drawing and Fig. 3b shows a photograph of the auxiliary VT in the panel before the panel was installed. The VT is mounted at the bottom of the panel, which makes the terminal labels hard to see. The installer, instead of confirming the physical labels on the VT terminal block, assumed that the wiring drawing represented the actual physical layout. In the wiring drawing, X2 is below H1 and X1 is below H2. However, the physical layout on the VT terminal block is actually the other way around—X1 is below H1 and X2 is below H2.

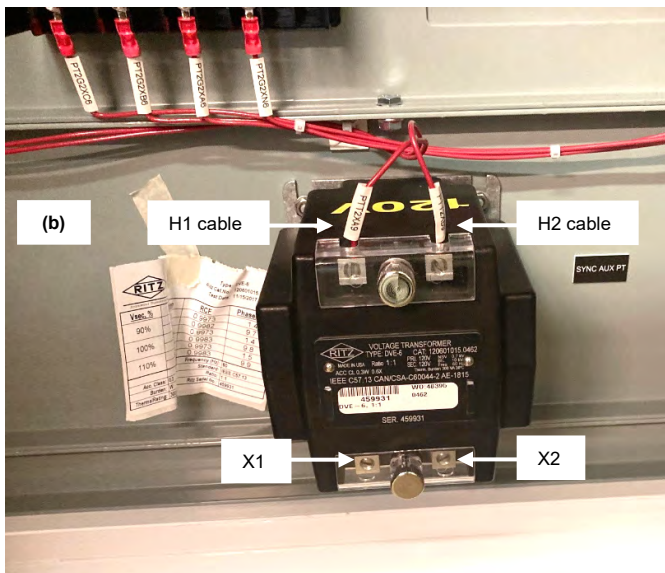
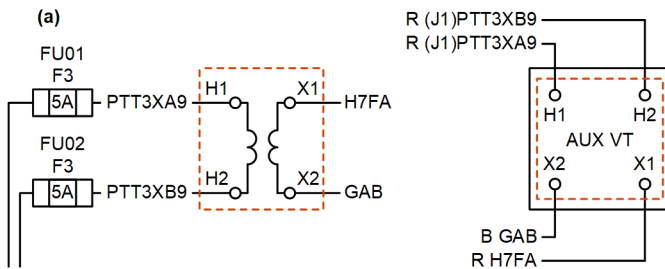

Fig. 3. Wiring drawing (a) and photo of terminal connections with error (b).

The primary synchronization system with the 16 kV unit breaker is located at the generation control panel, which includes all the other generator controls. However, the backup system, which synchronizes across the 500 kV breaker, was also being commissioned. The backup system was exercised for the first time on December 3, because the new auxiliary VT was installed as part of the commissioning test. The auxiliary VT wiring error had been there since its installation, but had never caused any issue until the 500 kV synchronization test.

During commissioning, a load test was performed to verify the current transformer (CT) and VT ratios. The load test was also to verify the polarity and phasing for all affected CT and VT circuits. The wiring error should have been caught by the load test; however, it was again missed. The measurement record was only marked for the auxiliary VT primary side, but was missed for the secondary voltage measurement from the worker's handwritten paper.

The VT secondary record was then filled with perfect data when the raw data were transferred to the official electronic load test report; this was a consequence of using the previous unit's report as the template. After that, the official load test report was reviewed and passed, which also explains why poor synchronization was not suspected for the first event and why it occurred a second time.

The event data for the first event were from a filtered record, which does not capture the dc offset or harmonics. This event report is shown in Fig. 4. Because better data were required for some of the analyses, the event record for the second OOPS event (Fig. 2) is used for the rest of the discussions in this paper.

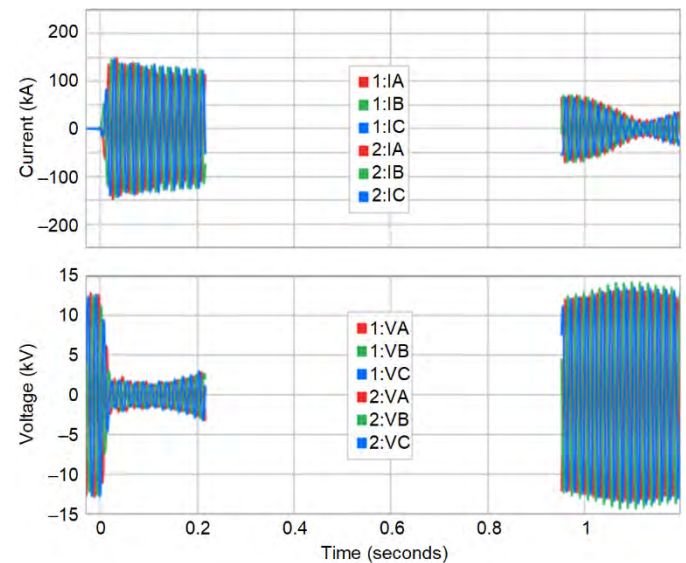

Fig. 4. First OOPS event (December 3, 2021).

III. EVENT ANALYSIS

A. Single-Machine Infinite-Bus System Equivalent (SMIB)

For the purpose of event analysis, the system of Fig. 1 is first reduced to the equivalent SMIB system at the time of the event and uses the parameters shown in Table I. The equivalent SMIB system is illustrated in Fig. 5. The parameters are all provided in per-unit of the generator ratings. The Z_{1SYS} parameter corresponds to the scenario at the time of the event, which had some generators offline. However, the possibility of a stronger system with those generators online and a lower system impedance is accounted for with the parameter Z_{1SYS_MIN} .

TABLE I
PARAMETERS FOR THE EQUIVALENT SYSTEM OF FIG. 5,
REFERENCED TO THE GENERATOR BASE

Parameter	Data
Generator rated MVA, current, and frequency	16 kV, 526 MVA, 19 kA, and 60 Hz
X_d , X_d' , and X_d'' X_q , X_q' , and X_q''	1.053, 0.22, and 0.180 pu 0.586, 0.586, and 0.301 pu
T_d' and T_d''	1.02 and 0.061 seconds
H (inertia constant of the generator and turbine)	5.45 seconds
GSU impedance (X_T)	0.1471 pu
System equivalent impedance	$Z_{1SYS} = 0.04819 \text{ pu} \angle 85.83^\circ$ $Z_{0SYS} = 0.03074 \text{ pu} \angle 89.44^\circ$
System minimum equivalent impedance	$Z_{1SYS_MIN} = 0.03771 \text{ pu} \angle 85.83^\circ$ $Z_{0SYS_MIN} = 0.03074 \text{ pu} \angle 89.44^\circ$

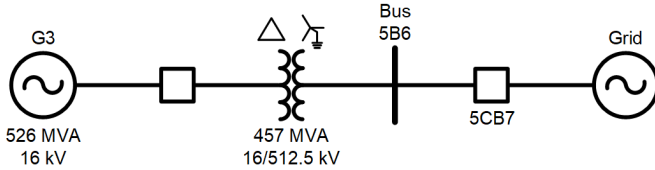

Fig. 5. Reduced SMIB system equivalent at time of event.

The fault current contributions for the three-phase and single-line-to-ground faults at the 500 kV bus are shown in Table II.

TABLE II
500 KV BUS 5B6 FAULT CURRENT CONTRIBUTIONS

Fault Type	Generator or GSU Contribution	System Contribution
Three-phase	1.87 kA (3.15 pu)	12.4 kA (with Z_{1SYS}) 15.8 kA (with Z_{1SYS_MIN})
Single-line-to-ground	2.79 kA (with Z_{1SYS}) 3.25 kA (with Z_{1SYS_MIN})	13.3 kA (with Z_{1SYS}) 15.5 kA (with Z_{1SYS_MIN})

The single-line-to-ground fault currents are similar to or higher than the three-phase fault currents because of the strong zero-sequence impedance path that is presented by the several nearby GSUs in the plant. This is also evident from Table I, which shows a Z_{0SYS} value that is smaller than the Z_{1SYS} value. The system zero-sequence impedances that are associated with

having G2 and G5 offline instead of online, Z_{0SYS} and Z_{0SYS_MIN} , are equal. This is because the GSUs are connected to the bus regardless of individual low-voltage (LV) generator breaker statuses.

For an OOPS event in this system, the maximum electromagnetic torque (T_{EM}) and maximum current (I_{AC}) can be estimated as a function of the synchronizing angle δ_0 using (1) and (2) as follows [4].

$$T_{EM} \sim \frac{V^2}{X_{TOTAL}} \left[\sin(\delta_0) + 2 \sin\left(\frac{\delta_0}{2}\right) \right] \quad (1)$$

$$I_{AC} \sim \frac{2 \cdot V}{X_{TOTAL}} \sin\left(\frac{\delta_0}{2}\right) \quad (2)$$

where:

V is the generator or system voltage magnitude (typically 1 pu).

X_{TOTAL} is the sum of X_d'' , X_T , and X_{SYS} .

The torque and currents for the different synchronizing angles for this system and for an infinitely strong system are shown in Fig. 6. As in the system featured in this paper, power systems are usually much stronger than the impedances presented by the generator and the GSU. This makes it so that in most installations, the torque and currents for an OOPS event are primarily limited by the generator and GSU impedances. The torques and currents in Fig. 6 do not consider the unit's saliency. However, the difference is not significant enough—less than 5 percent torque difference and about 10 percent current difference for our application—to justify the added complexity that would be associated with a revision of these equations. It can also be observed from (1) and (2) and Fig. 6 that the anticipated maximum electromagnetic torque and current are experienced when the synchronizing angles are 120 degrees and 180 degrees, respectively.

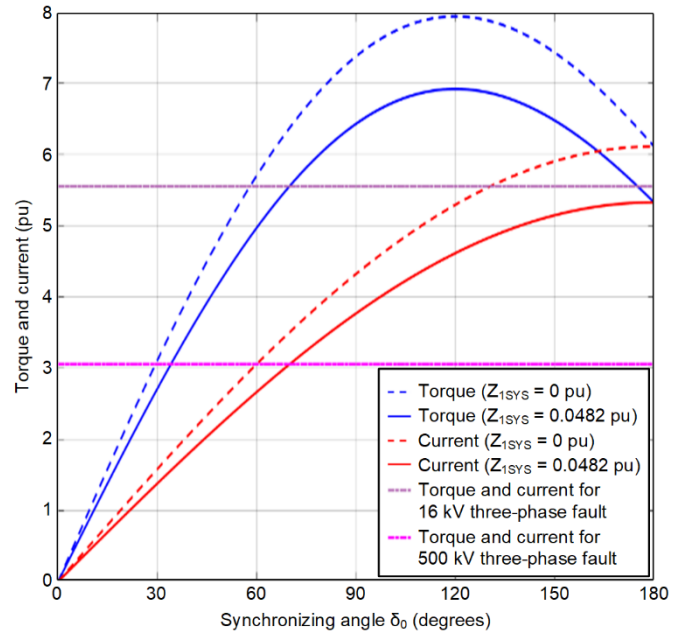

Fig. 6. Torque and current for a three-phase fault at generator terminals and for OOPS events versus synchronizing angle.

The simplified equivalent circuit for an OOPS event and a three-phase fault at the generator terminals can be represented by Fig. 7.

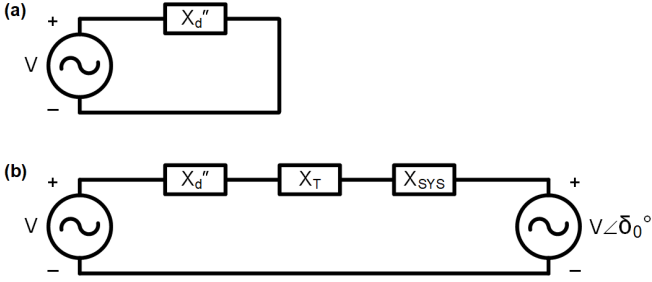

Fig. 7. Simplified equivalent circuit for (a) three-phase fault and (b) OOPS event.

For a three-phase fault, the maximum electromagnetic torque ($T_{3\Phi}$) and maximum current ($I_{3\Phi}$) can be represented by (3) and (4) [5].

$$T_{3\Phi} \sim \frac{V^2}{X_d''} \quad (3)$$

$$I_{3\Phi} \sim \frac{V}{X_d''} \quad (4)$$

A current of 1 pu in Fig. 6 corresponds to 19 kA at the LV (16 kV) level (see Table I) or 593 A at the HV (512.5 kV) level. For comparison, a three-phase fault on the 500 kV bus results in both a torque and current of 3.06 pu. In this system, an OOPS with a δ_0 of about 34 degrees and an OOPS with a δ_0 of about 70 degrees result in similar torque and current levels as a three-phase fault on the 500 kV bus, respectively.

Further, a three-phase fault on the 16 kV bus results in a torque and current of 5.55 pu, which is associated with the torque during an OOPS with a δ_0 between 70 and 175 degrees. The GSU for this system adds significant impedance, so the currents during an OOPS event do not reach the magnitude of the currents during a three-phase fault on the 16 kV bus for any δ_0 . Thus, the anticipated electromagnetic torque for a 180-degree OOPS event on G3 is about the same as what it would be for a three-phase fault at the generator terminals.

B. Evaluation of Damage Due to OOPS Event

The transient torque during an OOPS event can cause fatigue and loss of life to the machine's shaft and prime mover [5]. There are also high currents that, similar to a through fault, can cause mechanical and thermal damage to the windings of the generator stator and the GSU.

1) Relating Torque During Event With Closing-Angle Guidelines From IEEE Std C50.12 and IEEE Std C50.13

To get an indication of the severity of the OOPS event on the shaft and prime mover, the event report data of Fig. 2 were used to calculate the electromagnetic torque shown in Fig. 8. The electromagnetic torque is in per-unit based on the generator ratings, and it was calculated using the phase-to-phase voltages and currents using the method presented in [6].

The torque from Fig. 8 is about 4 pu. This electromagnetic torque has significant initial peak-to-peak oscillations. According to IEEE Std C50.12 [1] and IEEE Std C50.13 [2], a reasonable closing angle is within 10 degrees. For this system, a closing angle of 10 degrees using Z_{1SYS} from Table I results in a torque of 0.927 pu, which is lower than the rated torque of the generator. Equation (5) shows the calculation.

$$T_{EM} \sim \frac{(1 \text{ pu})^2}{(0.180 + 0.1471 + 0.0482)} \left[\sin(10^\circ) + 2 \sin\left(\frac{10^\circ}{2}\right) \right] \quad (5)$$

With the use of the Z_{1SYS_MIN} parameter, the associated torque is 0.972 pu. If the system is made infinitely strong, with a Z_1 of 0 pu, then the associated torque is 1.06 pu. A 10-degree synchronizing angle, considering the impedances of the generator and the GSU, results in a transient torque that is very close to the generator rated torque. Therefore, using a per-unit torque calculation to get an indication of the severity of an OOPS event to the generator shaft and prime mover is a reasonable approach.

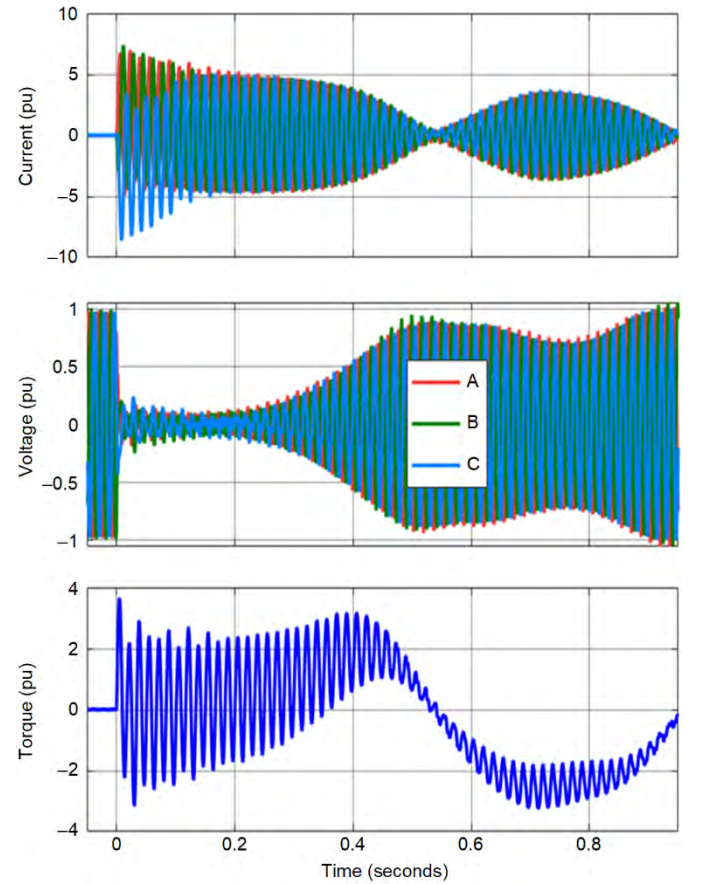

Fig. 8. Calculated torque during OOPS event.

2) Relating Time Overcurrent During Event With Withstand Characteristics From IEEE Std C57.109

The overcurrent throughout the event was high and lasted a significant amount of time. Transformers have damage withstand curves that overcurrent relays and fuses can coordinate with to limit mechanical and thermal damage from uncleared through faults [7]. The time overcurrent

characteristic for the applicable Category IV transformer, larger than 10 MVA single-phase and 30 MVA three-phase, is shown in Fig. 9.

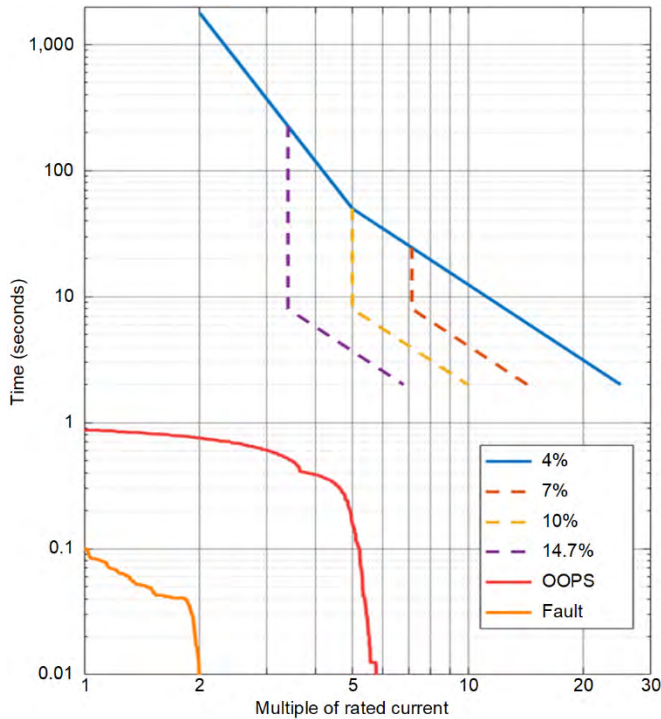

Fig. 9. Time overcurrent during events plotted, with respect to the standard Category IV transformer characteristics.

The standard characteristic in this figure, which the transformer is designed to withstand, has multiple curves for high currents because the transformer impedance limits the fault current from exceeding the upper values. For instance, for a transformer with a 10-percent impedance, the upper limit of the withstand characteristic ends at 10 times (100-percent voltage/10-percent impedance) the transformer rated current.

The time overcurrent characteristic during the OOPS event with the available data, after the differences in ratings between the generator and the GSU have been compensated for, is shown by the red trace below the withstand characteristic of Fig. 9. There was sufficient margin relative to the withstand characteristic for the GSU with 14.7-percent impedance.

Of particular note is that ground faults can result in higher currents through the GSU winding (see Table II). In unit-connected generators without an LV generator breaker, it is possible for a ground fault at the HV terminals to remain uncleared for some time because the generator continues to feed the fault despite a trip. IEEE Std C57.116 [8] discusses the possibility of long fault durations in a generating plant for unit-auxiliary transformers; engineers selecting a GSU might also want to take this possibility into consideration.

Considering the margin with the withstand characteristic, and considering through ground faults that can result in high fault currents in a GSU winding, this paper concludes that the torsional damage to the shaft is possibly a bigger concern [5] than overcurrent damage to the GSU winding during OOPS

events. However, it should be recognized that mechanical damage because of high currents is cumulative, similar to torsional damage to the shaft, and multiple OOPS events can eventually lead to a failure [5].

3) Comparison of Damage From a Through Fault

In 2018, a lightning-induced CAG fault occurred on Line 2, 91 kilometers (56.5 miles) from the generating plant. This event was recorded by the relay protecting G5, which has a similar rating as G3. There was another generator online at the time, so the operating conditions were slightly different. Nevertheless, when normalized, the parameters of this event can be compared to the torque, currents, and event duration of the OOPS event. This comparison is shown in Table III.

TABLE III
COMPARISON OF EXTERNAL CAG FAULT AND OOPS EVENT

Characteristic	External CAG Fault	OOPS Event
Torque	2.3 pu	3.7 pu
Current	1.7 pu	5 pu
Duration	3 cycles	> 60 cycles

From the Table III comparison, it is evident that the torque, current, and duration were all much more severe for the OOPS event than they were for the external fault. Because the fault occurred some distance away, the infeed is an important consideration; it reduces the external fault current contribution from the generator. The time overcurrent characteristic of this fault is shown in relation to the OOPS event in Fig. 9, and, by comparison, it is much less severe. Even for a breaker failure scenario or a slow-cleared fault, looking at the torque and current levels from Table III and ignoring the duration, the associated damage is expected to be less severe than associated damage for the OOPS event.

The event report and the calculated torque in per-unit quantities for the CAG fault are shown in Fig. 10.

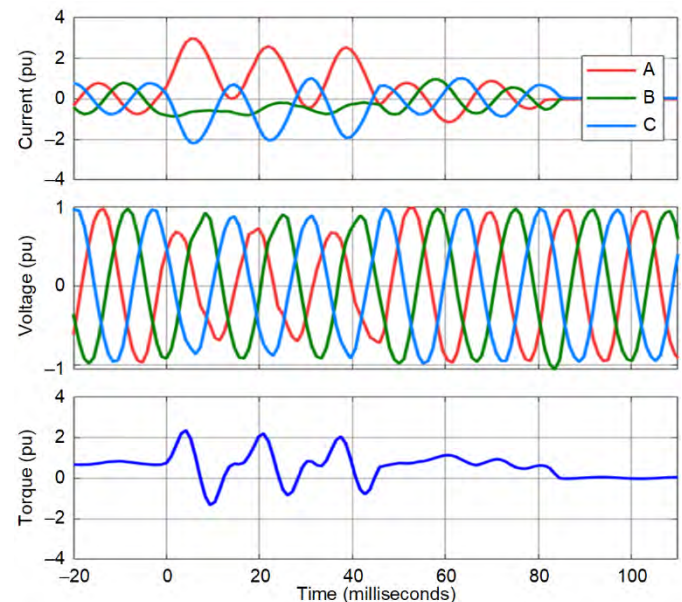

Fig. 10. External CAG fault that occurred 91 kilometers (56.5 miles) from the generating plant.

An important and relevant characteristic of the fault shown in Fig. 10 is that, unlike most faults (which occur near a voltage peak), this fault occurred near a zero-crossing of the fault loop voltage, V_{CA} . Because of the point-on-wave of fault inception, the faulted phase currents had a very high dc offset. This high dc can contribute to delayed zero-crossings and is a much more important consideration for OOPS events. This is discussed further in Section IV.

C. Protection Element Response During OOPS Event

During both OOPS events, several of the common generator protection elements [9] [10] picked up. However, none of these elements tripped. The behaviors of the different generator protection elements are discussed in this subsection [11]. An event report with the response of the protection elements is shown in Fig. 11.

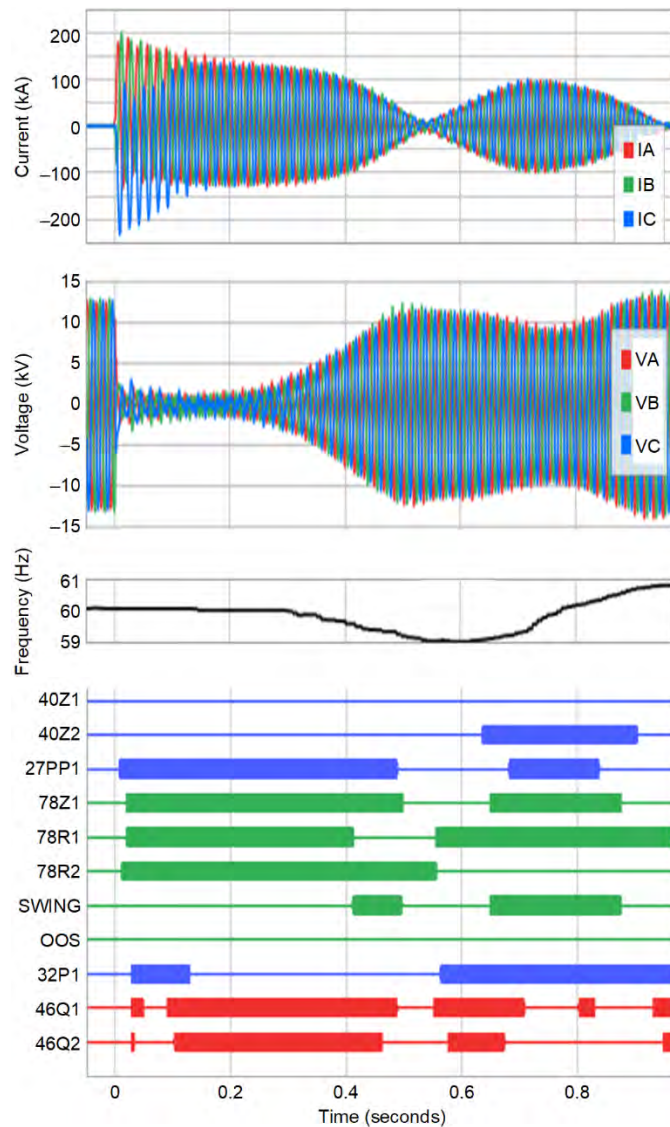

Fig. 11. Response of protection elements during OOPS event.

1) Loss-of-Field Element

The loss-of-field element was configured as Scheme 2 [9], with a positive-offset Zone 2 to have improved dependability during underexcited operation, as shown in Fig. 12. Zone 1 was

set based on the generator X_d , but had the diameter set slightly smaller to better coordinate with the generator capability curve and the steady-state stability limit. The Zone 1 time delay was set to 0.25 seconds to quickly clear a loss-of-field condition during heavy load. Zone 2 was set using the positive offset associated with the GSU and system impedance, and it was adjusted slightly to better coordinate with the underexcitation limiter. The directional line was set with a tilt of -20 degrees. Zone 2 was set to trip for lightly loaded conditions, with a time delay of 1 second. It also has an accelerated path where, if the phase-to-phase undervoltage level were to remain below 80 percent, the element would trip in 0.25 seconds.

Immediately after the OOPS event, the impedance locus entered the Zone 2 mho characteristic but remained above the directional line; therefore, Zone 2 did not assert. If the directional line were set with a lower tilt of -10 degrees, then Zone 2 could have tripped on the accelerated path, because the undervoltage lasted about 0.47 seconds. The impedance locus never entered Zone 1.

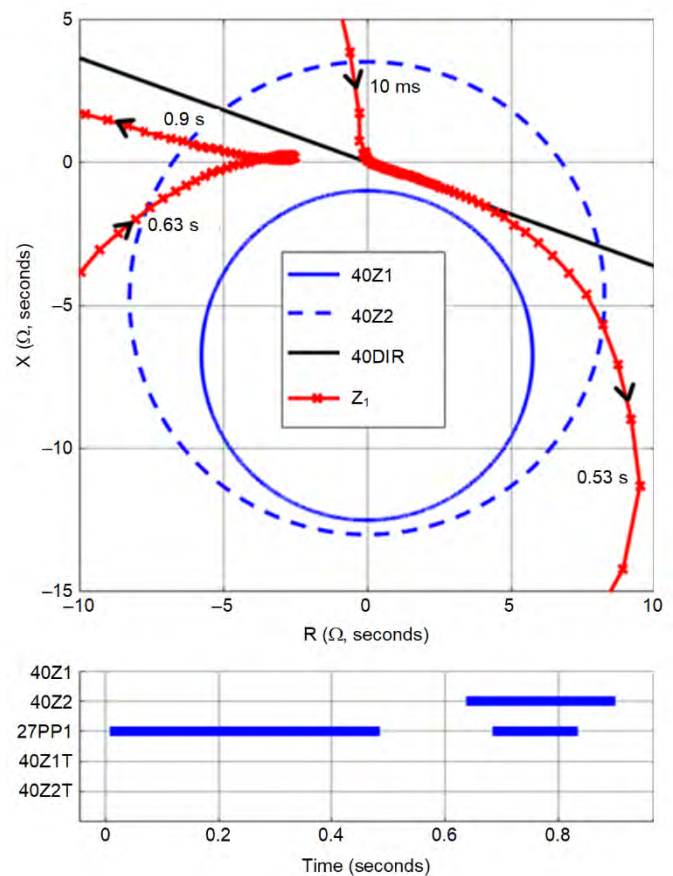

Fig. 12. Loss-of-field element response during OOPS event.

After 0.63 seconds, the impedance locus entered Zone 2 from the left. This time, the directional check was satisfied, but the undervoltage condition lasted about 0.15 seconds; therefore, the element did not trip on the accelerated path.

This was not a loss-of-field event, and the protection element did not trip. However, it is clear that the element could have tripped on Zone 2 if the conditions were slightly different or if the directional element was set with a lower tilt of -10 degrees.

2) Out-of-Step Protection

The out-of-step element was configured as a single-blinder scheme, as illustrated in Fig. 13. The element trips if a swing is detected when the positive-sequence impedance enters Region A or Region C, then moves to Region B, then exits in the opposite direction of Region C or Region A. The 78Z1 bit asserts when the impedance enters the 78Z mho characteristic, 78R1 asserts when the impedance is to the left of the associated blinder, and 78R2 asserts when the impedance is to the right of the associated blinder. Every data point in the impedance locus of Fig. 13 corresponds to a 4-samples-per-cycle record that is a downsampled version of the higher-resolution record shown in Fig. 11.

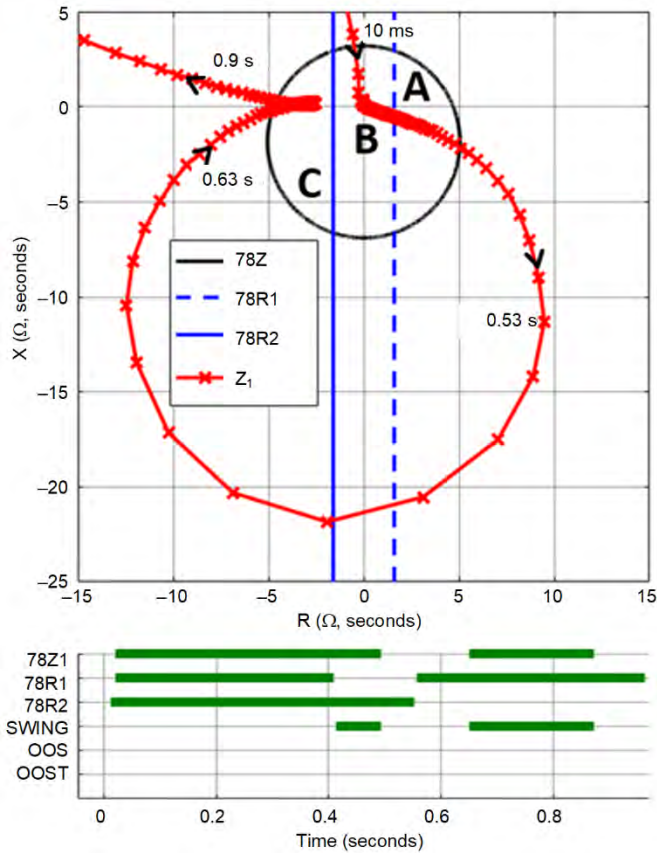

Fig. 13. Out-of-step element response during OOPS event.

The generator had no load prior to switching and was subjected to out-of-phase closing (the initial rotor position was 180 degrees). Immediately after the breaker closed, the impedance locus entered Region B from about 90 degrees. Even if it had entered from the right, the scheme requires the impedance locus to remain in Region A for at least three samples to ensure that it is a swing with slow trajectory and not a fault with fast trajectory. Because the initial change associated with the OOPS event was sudden, as it would be for a fault, the element did not classify it as a power swing.

After about 0.4 seconds, the element went from Region B to Region A, thereby asserting the SWING bit. At about 0.5 seconds, the rotor angle approached 0 degrees, the current approached a minimum, the locus moved out of the

78Z characteristic, and the SWING bit deasserted. The single-blinder scheme effectively reset.

After 0.65 seconds, the swing locus entered Region C. The impedance locus moved slowly and behaved like a swing; therefore, the SWING bit asserted. However, the characteristic never entered Region B and, therefore, was not classified as an out-of-step condition because the swing remained stable. This is also visible in the currents and voltages of Fig. 11, where the system recovered. If the swing had become unstable, and the associated impedance locus moved from Region C to Region B and then exited from Region A, the single-blinder scheme would have been expected to trip.

The unit experienced large power swings, but it was eventually pulled into synchronism with the system and did not trip; i.e., the OOPS event did not result in an unstable power swing. An OOPS event is normally expected to pull into synchronism because the generator is not loaded prior to the event. The out-of-step protection behaved correctly and did not operate for stable power swings as expected.

3) Reverse Power Element

Generator G3 is able to operate as a synchronous condenser like the other generators in this plant. During synchronous condenser operation, based on operating data, G3 had a typical maximum reverse power value of -12 MW. The reverse power element pickup was set to -20 MW (-3.8 percent) with an alarm at 20 seconds and a trip at 140 seconds.

The reverse power element response is shown in Fig. 14. It asserted initially for about 100 milliseconds when the machine motored slightly. Then, after 0.56 seconds, when G3 absorbed nearly 3 pu real power, the element asserted for about 0.42 seconds. The element never timed out to alarm or trip during this event because of the oscillations.

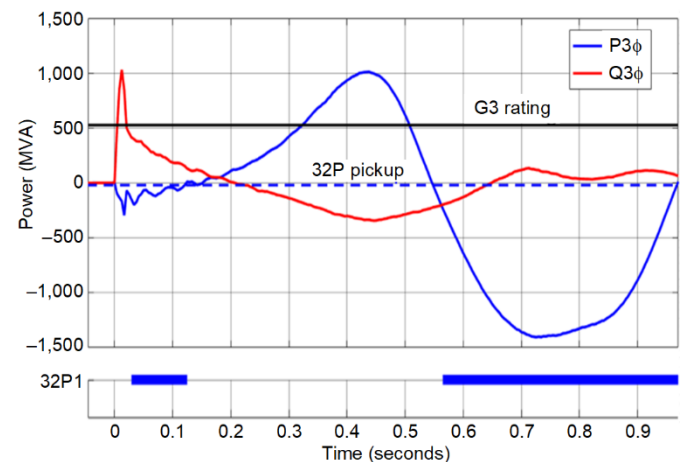

Fig. 14. Reverse power element response during OOPS event.

The reverse power element did not trip during the transient, but it could trip later, during load, for OOPS events caused by other wiring errors. If the VTs used by the generator relay are inverted in polarity and the machine starts generating, it can appear as if the machine is motoring to a reverse power relay. However, this is not a reliable indicator. As was the case here, the VTs used by the generator relay could be wired correctly.

4) Current Unbalance Element

For the current unbalance element that uses the negative-sequence current (I_2) as the operating quantity, the definite-time Level 1 was set with a pickup of 5 percent to alarm after 10 seconds. The inverse-time Level 2 was set with a pickup of 7 percent and a permissible K (I_2^2t) value of 5 to coordinate with adjacent line protection and trip for a generator unbalance.

The response of the element is shown in Fig. 15. This event had balanced currents, but there is evidence of dc CT saturation at about 50 milliseconds, where the C-phase current lost its dc component quickly. In this raw event record, the other set of phase CTs associated with the differential was not available, so the residual current ($3I_0$, shown in black in Fig. 15) was used to get a clearer indication of saturation. This is a sound approach for analysis because the high-impedance grounding meant that $3I_0$ was not expected. The $3I_0$ crept up when the CT saturated, as shown.

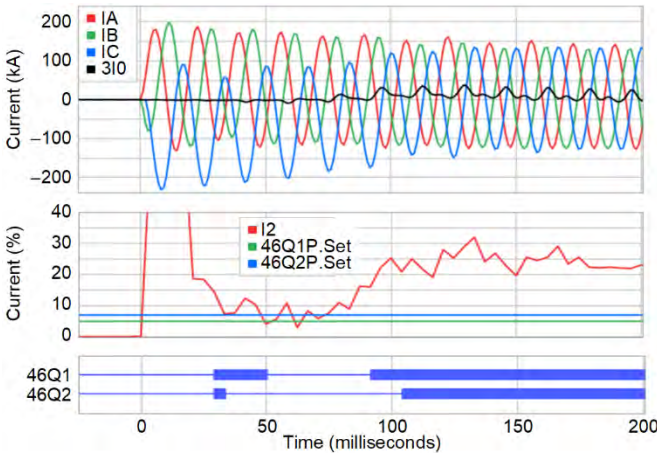

Fig. 15. Presence of I_2 and I_0 due to CT saturation during OOPS event.

The I_2 magnitude associated with the saturation, ignoring the initial filter transient and pole scatter, increased to a value of about 30 percent of the generator rating, before it started to decrease and eventually dropped to zero at about 0.5 seconds (not shown). The protection worked correctly because it was intended to not operate on switching operations introducing I_2 transiently from unequal saturations of three-phase CTs. A value of about 30 percent is associated with a current unbalance element trip time of about a minute. CT saturation should not be relied on to detect this condition, even though (as explained later in Section IV.D) it sometimes causes a sympathetic trip during an OOPS event.

5) Inadvertent Energization

The inadvertent energization element was not enabled in the relay, but it is a generator protection element that is most closely related to an OOPS event and therefore worth evaluating. The simplest implementation of an inadvertent energization scheme is the voltage-supervised overcurrent scheme shown in Fig. 16 [9] [10]. It is sometimes referred to as the 50/27 scheme. An undervoltage condition arms the scheme by verifying that the generator has been de-energized for the pickup time. The dropout timer provides a window of opportunity to trip when an overcurrent occurs as a result of an inadvertent energization of the generator. In certain

implementations [10], the security of the arming path is enhanced through the addition of a check for the field breaker being open or the presence of an undercurrent condition.

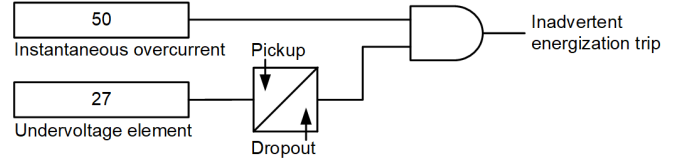

Fig. 16. Inadvertent energization scheme implemented as voltage-supervised overcurrent.

The inadvertent energization element detects an energization of a de-energized generator. Therefore, it cannot trip for an OOPS event that occurs on an energized generator that has healthy voltages and is ready to synchronize.

6) Protection Summary

Based on the event analysis, this paper concludes that all generator protection elements responded correctly by not tripping. The conditions that the various elements were designed to detect are not present in an OOPS event. The elements are, therefore, not expected to operate, although some of them might pick up and even misoperate for this type of event. Based on experience from other installations, as covered in Section IV.D, the most common trip during an OOPS event originates from a differential element misoperating because of CT saturation.

In the next section, this paper discusses a dedicated OOPS element that can reliably detect this condition, the challenges with its application, and possible solutions.

IV. DEDICATED OOPS PROTECTION AND ALARMING CONSIDERATIONS

A. Delayed Zero-Crossings During OOPS Events

The delayed zero-crossings phenomenon for OOPS events has been discussed in previous literature [3] [4] and is much more severe than it is for external faults. This is illustrated in Fig. 17, which shows a comparison of a simulated three-phase fault at the GSU HV terminals and an equivalent 60-degree OOPS simulated event that has a similar current envelope (because they have the same voltage difference). For the three-phase fault, the ac current magnitude reduces during the event. This is because of the gradual transition from subtransient to transient reactance, which makes it nearly lose zero-crossings.

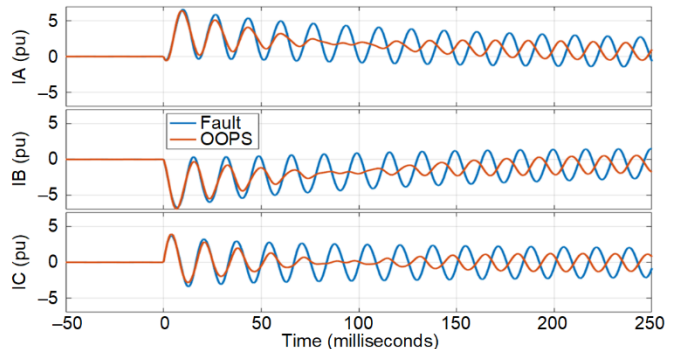

Fig. 17. Behavior of zero-crossings during three-phase fault and 60-degree OOPS simulation.

The near loss of zero-crossings on the faulted phases and the actual loss of zero-crossings on the unfaulted phase was also evident from the field event of the external CAG fault (Fig. 10) that had significant dc offset in the currents. The point-on-wave of fault inception made it so that the dc offset of the A-phase fault current had the same polarity as the load. That fault was 91 kilometers (56.5 miles) away, which reduced the X/R ratio and the dc time constant of the fault current. If the fault were closer, it is possible that the current could have had delayed zero-crossings.

For an OOPS event like the one shown in Fig. 17, the decaying ac component associated with the transition from subtransient to transient reactance, as for an external fault, still exists. Additionally, as the rotor pulls in with the system, the voltage difference between the generator and the system decreases relatively quickly. This reduced voltage difference lowers the ac component of the fault current further, increasing the likelihood of delayed zero-crossings [4].

As discussed in [3], the issue is not likely to occur for LV generator breakers, because the arc resistance introduced when the breaker contacts part reduces the X/R significantly. The breaker arc voltage is also a greater percentage of the lower voltage level. However, modern 500 kV SF₆ breakers, like the ones in the application in this paper, have a much lower tolerance to missing zero-crossings than traditional air-blast extra-high-voltage circuit breakers [12] [13]. In the last ten years, BC Hydro has experienced five failures of relatively new 500 kV breakers that were attempting to interrupt currents with small dc offsets. Thus, there is genuine concern of breaker failure from delayed zero-crossings during an OOPS event.

B. Tripping and Alarming Considerations

Tripping and alarming for OOPS can be achieved using the simple scheme of Fig. 18, which has been applied for over 20 years. When using the OOPS scheme to trip an LV generator breaker, tripping should be initiated immediately, without any intentional delay. The scheme might need to be disabled for certain black-start applications [3].

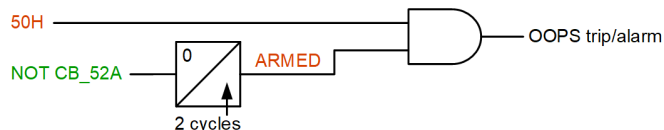

Fig. 18. OOPS scheme logic.

Modern 500 kV SF₆ synchronizing breakers, as explained in Section IV.A, can be challenged when interrupting OOPS currents because of the risk of delayed zero-crossings. Because the zero-crossings are delayed and eventually do reappear, an initial response might be to attempt to delay the trip. However, based on [4] and simulation data [3], the time delay for a loss and subsequent reappearance of zero-crossings depends on several factors and can be difficult to quantify. Because of this, the authors of this paper do not recommend delayed tripping as a good option to mitigate a possible 500 kV SF₆ breaker failure.

One option that the authors discussed was to alarm for certain OOPS events. As is shown by this paper, an OOPS alarm could have alerted the operator and prevented the second

OOPS event from occurring. Typically, a 180-degree OOPS event does not result in delayed zero-crossings [3]; therefore, tripping can be initiated by adding a high-set level that can trip for a 180-degree OOPS event. Using this option means that the generator and GSU might be subjected to long-lasting forces, because trips will not be initiated for OOPS events involving closing angles that are less than 180 degrees.

Another option is to trip the breaker and accept the risk of a breaker failure and the system impact associated with a breaker failure trip. Some utilities may consider sacrificing a breaker for the more expensive assets—the generator and the GSU. In BC Hydro, breakers had failed catastrophically when interrupting currents with missing zero-crossings. Thus, the option of tripping 500 kV breaker for an OOPS event was deemed as a safety risk and not pursued.

C. Application Considerations

The simple scheme of Fig. 18 works well for the purpose of tripping a LV generator breaker. However, as explained in Section II, this breaker was already closed prior to the event. Therefore, even though there was significant current because of the OOPS event, the element was correctly disarmed based on the breaker status, and it did not trip.

After the event, it became evident that some form of protection or alarm might have helped detect the first OOPS event and, at the very least, prevented the second OOPS event. The authors considered two simple alternatives to restore the lost dependability for this event.

1) OOPS Scheme for Dual-Breaker Bus Configurations

One reason that the OOPS scheme of Fig. 18 was not applied to the 500 kV breaker was because of the high bus current ratings and the possibility of closing either of the ring-bus breakers, 5CB6 or 5CB7, to synchronize the generator. For example, if 5CB6 is already closed and 5CB7 is subsequently closed, a high current could flow through the breaker that closed second, thus jeopardizing the security of the OOPS protection scheme shown in Fig. 18.

An alternative to the scheme of Fig. 18 for dual-breaker configurations is shown in Fig. 19. If either breaker is closed, the scheme is disarmed and remains secure. The overcurrent element operates on the partial differential current of the two breakers. For the system shown in Fig. 1, this current corresponds to the generator current and can, therefore, be set in a similar manner as the scheme of Fig. 18 [3]. The phasor sum of the two currents can be obtained by paralleling the CTs externally, using a relay designed for two breaker applications that internally sums the current, or by using programmable math in a digital relay.

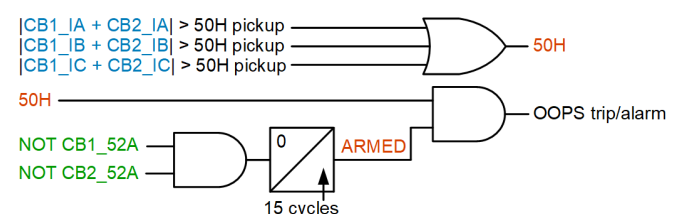

Fig. 19. OOPS element for HV synchronizing breakers in dual-breaker configuration.

Once the scheme operates, to avoid the problem of delayed zero-crossings on the 500 kV breakers, the unit generator breakers connected to the bus can be tripped. For example, if the scheme operates on the relay measuring currents from 5CB6 and 5CB7 of Fig. 1, then G3 and G4 can be tripped. This works because the only scenario where a generator is being synchronized using the 500 kV breaker instead of the generator breaker is when the other generator is out of service. Tripping both breakers trips the closed one that is involved in the OOPS event and a breaker that is already open because the generator is not in service.

The one-line diagram in Fig. 1 is simplified and does not show the many disconnect switches that add operational flexibility at this plant. These switches are shown in green in Fig. 20. For instance, depending on the position of the switches, 5CB6 and 5CB7 might no longer synchronize G3 and G4, but could synchronize any other generator. The presence of these switches can add significant scheme complexity, because their status requires consideration before the appropriate unit generator breaker is tripped. Furthermore, the generators might have different parameters that could impact the 50H pickup setting. For a plant with such operational flexibility, the scheme of Fig. 19 would require some additional complexity, as described in the next paragraph. However, this scheme can be an excellent choice for plants with no unit generator breaker and a dual-breaker bus configuration.

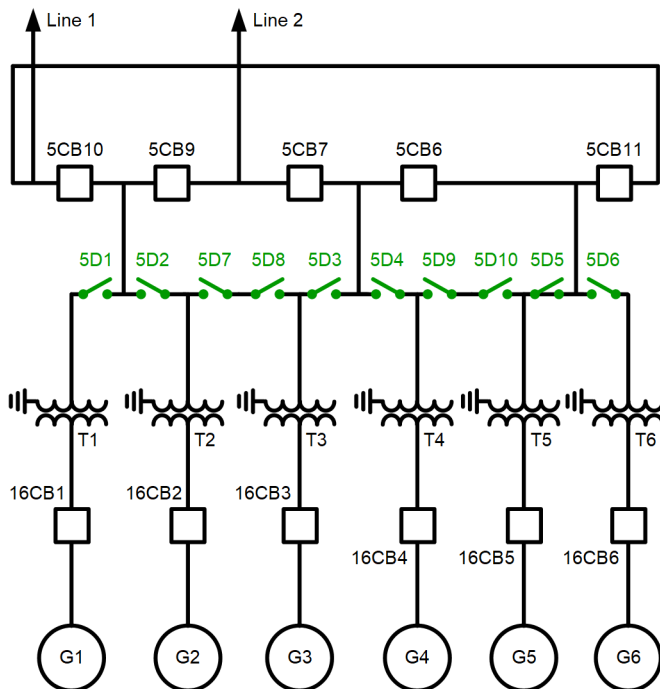

Fig. 20. One-line diagram showing switches that add plant operational flexibility.

A solution for the application shown in Fig. 20 should not rely on problem-prone topology tracking of the configuration switches. One proposed solution is for the 500 kV breaker OOPS relays to send the trip to each generator relay. The generator relay would then only pass on the trip to its breaker if the generator were energized and carrying no real or reactive load before the event. This would indicate that the generator is

the one unit that is being synchronized at the time that the OOPS scheme operates. In most cases, a generator that is operating in condensing mode would be carrying measurable levels of reactive power, and a generator that is operating as a generator would be carrying measurable levels of real power.

2) Arming OOPS Scheme Using Currents

An alternative to the OOPS scheme of Fig. 18 is shown in Fig. 21; it does not rely on breaker status. The arming path uses a 50L element that picks up for all loading scenarios but not GSU magnetizing current. A 50L pickup of 0.5 to 3 percent is adequate for most applications. The 50H has an additional rising edge to the AND gate to improve security. The dropout timer of the arming path is shortened to two cycles to accommodate timing differences associated with 50H, 50L, and the rising-edge trigger. This scheme looks for a high step change in current to declare an OOPS condition.

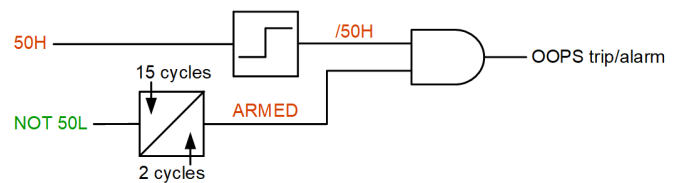

Fig. 21. OOPS scheme without reliance on breaker status.

For generator relays that do not support a low pickup value for the 50L element, a sensitively set reverse power level can be used to supplement the arming logic. For the system under study, the magnetizing current was less than 0.3 percent.

The dependability of the scheme of Fig. 21 for the second OOPS event is shown in Fig. 22. The 50L pickup is set to 1 percent of the generator rated current and the 50H pickup is set to 120 percent of the generator contribution to a three-phase fault on the high-side of the GSU, which is 70 kV (equal to $1.2 \cdot 3.06 \cdot 19$ kA). It is clear that the element is dependable for the 180-degree OOPS event and, based on the analysis from Section III.A, it would remain dependable for events with a synchronizing angle greater than 80 degrees.

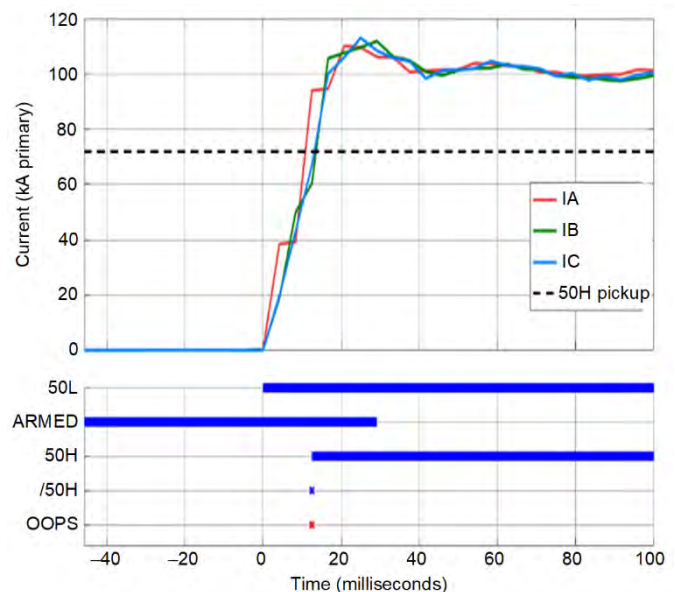

Fig. 22. Dependability of OOPS scheme for 180-degree OOPS event.

The security of the scheme for the external multiphase fault of Fig. 10 is shown in Fig. 23. The element does not remain armed because of the load current asserting 50L. Even if the element were armed, the fault current is not high enough to assert 50H, which is set to remain secure for a bolted three-phase fault at the GSU 500 kV terminals. Infeed and fault resistance further reduce the fault current so that the element is at no risk of a misoperation.

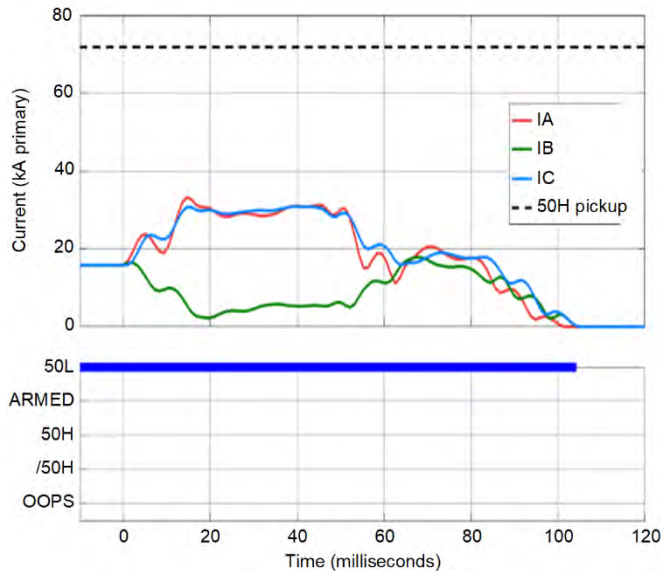

Fig. 23. Security of OOPS scheme for external multiphase fault.

D. Advantages of Using a Dedicated OOPS Scheme

As explained in Section III.C, commonly applied generator protection elements are not dependable for an OOPS event. The tale of Section II makes it evident that there was no knowledge of a synchronizing system failure until after the second event. There was no physical indication of the event. Even if the torsional forces had manifested into a physical phenomenon, the generator was inside a mountain, with the switchyard on top of the mountain, and solid rock in between; therefore, any physical indication could not have been felt. The OOPS scheme, on the other hand, uses reliable electrical signals to alert the user of a poor synchronization if it is configured to alarm. It can also trip to prevent long-lasting stresses to the generator and the GSU.

In another case [3], line current differential relays from one of two manufacturers misoperated because of CT saturation and cleared the condition in around six cycles. In that case, there was no physical indication of the poor synchronization either, even though the control room was located around 30 meters (100 feet) from the generator. The building did not shake, and the plant personnel initially indicated that the synchronization was perfect (zero degrees) based on the synchronizing panel information, even though it was later discovered to be an imperfect, 180-degree synchronization instead. There really is no certainty for a physical indication to be present or felt.

Using dedicated OOPS alarming or tripping also allows for proper targeting. It can make a user aware of the nature of the issue presented to the generator. The authors are aware of a case in which one of the two redundant relays protecting a generator

tripped on the phase differential element during an OOPS event. The relays were from two different manufacturers. The plant personnel indicated that one of the relays failed to operate for an internal fault, as was evident from the high fault currents. After significant time and investigation, when an internal stator winding fault could not be found, an OOPS event was determined to be the root cause. The relay that tripped had, in fact, misoperated because of CT saturation. The misoperation was fortuitous; otherwise, it would have been possible for future faulty synchronizations to occur. With dependable and dedicated targeting associated with an OOPS protection scheme, the cause becomes self-evident, which can subsequently translate to efforts that are better focused, outages with reduced durations, and significant cost savings.

V. LIFE AFTER POOR SYNCHRONIZATIONS—PATH FORWARD

After the two events with poor synchronization, heat runs were completed on the transformer. A heat run test measures the temperature rise above ambient of the transformer windings to help determine its integrity [14]. The heat runs were completed successfully. A combination of physical inspections and electrical testing was performed on all potentially impacted equipment to assess the impact of the two OOPS events, as follows:

- On the exciter, the governor, the generator breaker 16CB3, and the GSU T3, inspections and tests were performed. The condition assessments concluded that no indication of equipment damage was found on the equipment.
- On the generator isophase bus, two sections of the A-phase bushings had failed the HiPot test and were replaced by spare bushings. It could not be confirmed if the damaged components were a result of the OOPS event or not.
- On the generator, a visual inspection of the generator rotor, rotor poles, stator windings, circuit ring bus, stator core, and the accessories was performed. No visible damage was found.
- On the sole plates (made from self-lubricating material and used in turbines to suppress vibrations), inspections were carried out from inside the generator pit using a pole camera. The inspections concluded that it was safe to put the unit back in service.
- On the rotor and stator, the rotor winding resistance and the stator winding resistance were measured and were both found to be acceptable. Both the rotor and the stator passed the HiPot tests and the rotor pole drop test.

After these successful electrical tests and visual inspections, the generator was put back in service. Fortunately, there was no damage to the equipment, in spite of the two OOPS events. In contrast, the authors are aware of an OOPS event on an 800 MVA steam turbine generator that led to rotor damage and an outage of 98 days, with a total cost of about 16 million dollars. The cost of the generator repair, transportation, and labor was about 7 million dollars.

OOPS events can result in immediate damage, immediate fatigue, or cumulative loss of equipment life. A wiring error is the most common cause, which can manifest into an OOPS event when the machine is synchronized for the first time after changes to the wiring or the synchronizing system. Improvements to the OOPS protection discussed earlier will not prevent an event, but they can reduce the impact of an event. This paper makes the following two recommendations to prevent OOPS events:

- The synchronizer and any synchronism-check devices should be connected to independent circuits and separate VTs. This helps eliminate a common-mode failure from wiring and VT polarity errors.
- After modifications, wiring and polarity integrity should be verified before the synchronizing system is exercised for the first synchronization. The wiring and polarity can be checked by measuring the voltages at the terminals of the synchronization system (as supplied by VTs) when the unit is running and is synchronized using another system that is known to be functional.

VI. CONCLUSION

OOPS events are damaging to generators and occur more frequently than some of the other conditions that generator protection is intended to help mitigate. This paper tells the tale of two 180-degree OOPS events. Various methods were used to get a sense of the forces associated with the OOPS events. The OOPS events, because of the magnitude of the torque, currents, and duration, were considered to be several times worse than an external multiphase fault that occurred near the plant.

Several generator protection elements picked up during the OOPS events, but none tripped. The loss-of-field element could have tripped, if the scenario were slightly different. The out-of-step protection element considered the initial event as a fault and did not trip for the following stable power swings; it could only have been expected to trip if the generator had subsequently lost synchronism with the system. The reverse power and current unbalance elements were configured with long time delays and were not expected to trip. The inadvertent energization element did not remain armed because the generator was energized prior to the event.

BC Hydro had applied dedicated OOPS protection for over 20 years, but it was not applied to the breaker that precipitated the OOPS event because of high bus current ratings and high scheme complexity for this plant. Improvements to the OOPS element can provide greater application flexibility and reliably detect this condition.

Inspections and electrical testing were performed on the various equipment that could potentially be impacted by the OOPS event. Fortunately, no damage to the equipment was found, and the generator was put back in service. However, in other cases, significant damage has occurred, resulting in costs totaling millions of dollars.

The authors recommend eliminating a common-mode failure in the synchronizing system by using independent

circuits and different VTs for the synchronizer and the synchronism-check relay [15]. After any modifications to the synchronizing system, wiring and polarity checks should be validated before the first synchronization. The checks can be verified by measuring voltages at the synchronizing system terminals when the unit is running and has already been synchronized by a system proven to be functional. Section V of [3] provides more details on verifying synchronizing circuits.

VII. REFERENCES

- [1] IEEE Std C50.12-2005, *IEEE Standard for Salient-Pole 50 Hz and 60 Hz Synchronous Generators and Generator/Motors for Hydraulic Turbine Applications Rated 5 MVA and Above*.
- [2] IEEE Std C50.13-2014, *IEEE Standard for Cylindrical-Rotor 50 Hz and 60 Hz Synchronous Generators Rated 10 MVA and Above*.
- [3] K. Barner, N. Klingerman, M. Thompson, R. Chowdhury, D. Finney, and S. Samineni, "OOPS, Out-of-Phase Synchronization," proceedings of the 73rd Annual Georgia Tech Protective Relaying Conference, Atlanta, GA, May 2019.
- [4] I. M. Canay, D. Braun, and G. S. Koppl, "Delayed Current Zeros Due to Out-of-Phase Synchronizing," *IEEE Transactions on Energy Conversion*, Vol. 13, Issue 2, June 1998, pp. 124–132.
- [5] I. M. Canay, H. J. Rohrer, and K. E. Schnirel, "Effect of Electrical Disturbances, Grid Recovery Voltage and Generator Inertia on Maximization of Mechanical Torques in Large Turbogenerator Sets," *IEEE Transactions on Power Apparatus and Systems*, Vol. PAS-99, Issue. 4, July 1980, pp. 1357–1370.
- [6] D. Finney and D. Haas, "Electromagnetic Torque From Event Report Data – A Measure of Machine Performance," proceedings of the 44th Annual Western Protective Relay Conference, Spokane, WA, October 2017.
- [7] IEEE Std C57.109-2018, *IEEE Guide for Liquid-Immersed Transformers Through-Fault-Current Duration*.
- [8] IEEE Std C57.116-2014, *IEEE Guide for Transformers Directly Connected to Generators*.
- [9] IEEE Std C37.102-2006, *IEEE Guide for AC Generator Protection*.
- [10] IEEE, "IEEE Tutorial on the Protection of Synchronous Generators, Second Edition, Special Publication of the IEEE Power System Relaying Committee," IEEE PES Resource Center, August 2011. Available: resourcecenter.ieee-pes.org.
- [11] *SEL-300G Multifunction Generator Relay Instruction Manual*. Available: selinc.com.
- [12] R. D. Garzon, *High Voltage Circuit Breakers: Design and Applications*, Marcel Dekker, Inc., New York, NY, June 2002.
- [13] IEEE/IEC Std 62271-37-013, *International Standard for High-Voltage Switchgear and Controlgear – Part 37-013: Alternating Current Generator Circuit-Breakers*.
- [14] IEEE Std C57.12.90-2015, *IEEE Standard Test Code for Liquid-Immersed Distribution, Power, and Regulating Transformers*.
- [15] M. J. Thompson, "Fundamentals and Advancements in Generator Synchronizing Systems," proceedings of the 65th Annual Conference for Protective Relay Engineers, College Station, TX, April 2012.

VIII. BIOGRAPHIES

Mukesh Nagpal received PhD and MSc degrees in electrical engineering from the University of Saskatchewan in Saskatoon, Saskatchewan, Canada. His titles include distinguished lecturer of the IEEE Power and Energy Society; adjunct professor at the University of British Columbia, professional engineer in the province of British Columbia; and principal engineer/manager with the protection and control planning department at BC Hydro. He has about 35 years of experience, has written about 50 technical papers on power system relaying, and has contributed to several ANSI/IEEE sponsored standards and guides on relaying practices. Mukesh is a fellow of the IEEE.

Lesley Gu received her BS degree in electrical engineering from the Shanghai Jiao Tong University in 1989. She has 15+ years of experience in generation protection and control (P&C). Prior to joining BC Hydro in 2013, she worked in a consultant firm involved with electrical/P&C design for IPP hydro power plants and heavy industry. Lesley is a registered professional engineer in the province of British Columbia.

Ralph Barone has over 30 years of experience in power system protection and control. Ralph received his BAsC degree in electrical engineering from the University of British Columbia in 1988. He worked for BC Hydro from 1988 to 2019 in HVdc, telecom, and protection and control before becoming a consultant. Ralph is a senior member of the IEEE and a registered professional engineer in the province of British Columbia.

Ritwik Chowdhury received his BS degree in engineering from the University of British Columbia and his MS degree in engineering from the University of Toronto. He joined Schweitzer Engineering Laboratories, Inc. (SEL) in 2012, where he is presently a senior engineer in research and development. Ritwik holds 9 patents and has helped author 25 technical papers. He was recognized as an exceptional reviewer for *IEEE Transactions on Power Delivery* for 2019 and 2021. He is the vice chair of the Protection and Control Practices Subcommittee (I-SC) of the IEEE Power System Relaying and Control (PSRC) Committee, the chair of two IEEE Standards Working Groups, and the recipient of the 2021 PSRC Outstanding Young Engineer Award. Ritwik is a senior member of the IEEE and a registered professional engineer in the province of Ontario.

Michael Thompson received his BS, magna cum laude, from Bradley University in 1981 and an MBA from Eastern Illinois University in 1991. Upon graduating, he served nearly 15 years at Central Illinois Public Service (now Ameren). Prior to joining Schweitzer Engineering Laboratories, Inc. (SEL) in 2001, he worked at Basler Electric. He is presently a distinguished engineer at SEL Engineering Services, Inc. (SEL ES). He is a senior member of the IEEE, officer of the IEEE Power and Energy Society Power System Relaying and Control Committee (PSRC), and past chairman of the Substation Protection Subcommittee of the PSRC. He received the Standards Medallion from the IEEE Standards Association in 2016. Michael is a registered professional engineer in six jurisdictions, was a contributor to the reference book *Modern Solutions for the Protection Control and Monitoring of Electric Power Systems*, has published numerous technical papers and magazine articles, and holds three patents associated with power system protection and control.