

Cross Country Faults - Protection Challenges and Improvements

Venkatesh C, Ilia Voloh
GE Grid Solutions

Abstract—Cross Country faults (simultaneous/evolving faults at different locations) in transmission and distribution systems create challenges to distance, directional and phase-selection functions. Relay can miss to operate for in-zone faults or incorrectly operate for out-of-zone faults. This is because zero-sequence and negative-sequence components distribution through the protected line, used by above mentioned functions is not easy to predict. This affects both solidly-grounded and isolated/impedance grounded systems.

Single-pole switching is used in transmission network as it improves power system stability, compared to three-pole switching and also ensures system availability. In-order to correctly isolate the faulted phase, phase selector is used to supervise distance element when single-pole switching is enabled. However, certain fault scenarios such as high resistance faults, cross country faults pose a challenge to phase selector.

In this paper, we start with the basic principles of phase selection for single-location faults and then we provide insights into the limitations of detecting the faulted phase during cross country faults. Finally, we introduce the improved phase selection logic to handle cross country fault scenarios, which provides correct detection of faulted phase using local information.

NOMENCLATURE

V_r	relay voltage
I_r	relay current
V_A, V_B, V_C	phase voltages
I_A, I_B, I_C	phase currents
V_0, V_1, V_2	zero, positive and negative sequence voltages
I_0, I_1, I_2	zero, positive and negative sequence currents
a	$1 \angle 120^\circ$
Z_S	local source impedance
Z_R	remote source impedance
Z_{S1}, Z_{R1}	+ Seq. local and remote source impedance
Z_{S2}, Z_{R2}	- Seq. local and remote source impedance
Z_L	line impedance in phase domain
Z_{L1}, Z_{L2}	+ Seq. and - Seq. line information
Z_{L0}	zero Seq. line information
R_f	fault resistance
m	fault location in pu
k	residual compensation factor ($\frac{Z_{L0}-Z_{L1}}{3Z_{L1}}$)
KVL	Kirchoff voltage law
PS-AG	Phase selector indicating AG fault
PS-BG	Phase selector indicating BG fault
PS-CG	Phase selector indicating CG fault
PS-AB	Phase selector indicating AB fault
PS-BC	Phase selector indicating BC fault
PS-CA	Phase selector indicating CA fault
PS-ABG	Phase selector indicating ABG fault
PS-BCG	Phase selector indicating BCG fault
PS-CAG	Phase selector indicating CAG fault

I. INTRODUCTION

Ever growing energy demand on one side and the limitations on the right of way due to environmental constraints on the other hand forces the complex power system to operate near to their limits, utilizing the existing transmission network. Any disturbance e.g. fault in the transmission network may lead to stability issues, if faults are not detected and isolated on time and restored back without loosing synchronism. In olden days, three pole switching was used to isolate the line irrespective of the fault type followed by fast reclosing, as breaker technology was not mature.

As majority of the faults on transmission network is single phase to ground and mostly it is temporary, single pole switching has gained importance. With the evolution of technology, efforts were also directed to minimize the fault severity i.e. single pole switching, to improve stability limits, rather than improving the design characteristics of machines and transformers. This led to the first single-pole reclosing to be tested and put in service on a 50 mile section of 138kv single-circuit line on the system of the Public Service Company of Indiana, Inc around 1942[1].

The growing importance of single pole switching led to the introduction of phase selector relays to accurately identify the faulted phases. The use of phase selector relays in conjunction with distance relays helps to overcome the problem of 3 pole switching for a single phase to ground fault i.e. it is possible for a phase-fault distance element to operate for a single-phase to ground fault. The phase selection techniques are quite mature today to supervise and ensure correct single pole switching during normal single-phase to ground faults. However, in the presence of complex faults like cross-country faults, phase selection will be difficult to achieve, which is the focus of this paper.

In Section II we start with discussing different characteristics and the reason why we use MHO for line protection. Later, we discuss the limitation of classical MHO analytically which will help us to understand the need for phase selector.

Section III summarizes different kinds of phase selector and their limitations. This section also explains the basic operating principle of symmetrical component based phase selector. Later, we see the performance of this phase selector for unsymmetrical faults.

Section IV and Section V explains the complexity in handling cross country faults for solidly grounded system and emphasis the limitation of symmetrical component based phase selector and introduces a new composite approach to detect cross-country faults and identify faulted phase.

Section V provides overview of the application requirement for isolated/compensated networks i.e. phase preference tripping and provides details of how cross country fault is handled in compensated network.

II. WHY WE NEED PHASE SELECTOR?

One of the earlier options to protect transmission lines was to use time-graded overcurrent relays. However, as the fault coverage is dependent on the source impedance variations, overcurrent relays was not preferred, which led to the birth of distance relays. Initially, Impedance relays as shown in Fig. 1(a) were introduced to overcome the sensitivity problems of overcurrent and directional relays, as the fault current may vary over wide ranges due to operating or soil conditions, especially when the fault current is less than the full-load current.

Later, reactance type distance relays were introduced as distance to fault measurement is independent of arc resistance. Inorder to obtain directionality, MHO units were used along with reactance relay, as shown in Fig. 1(b) which were rapidly installed in 1930's [2].

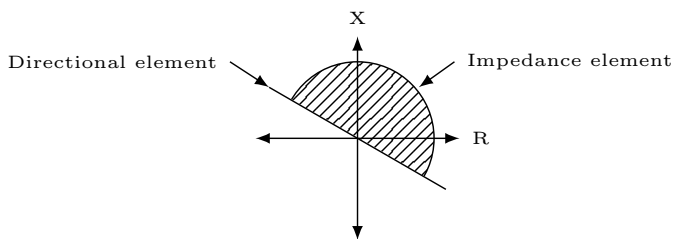

(a) Impedance with directional element

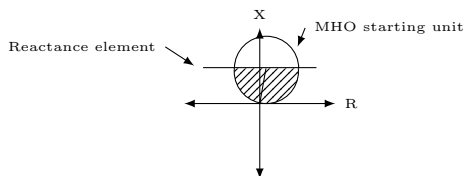

(b) Reactance with MHO starting unit

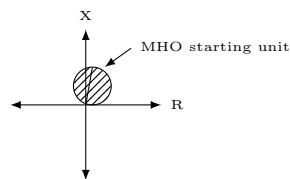

(c) MHO element

Fig. 1: Characteristics

Slowly, as phase selection gained importance, it was realised that impedance and reactance relays cannot provide selective tripping and are susceptible to power swings because of their large tripping areas. The starting unit of reactance relays i.e.MHO units, was latter preferred especially for long lines as it can effectively prevent tripping for power swings

and relatively provides better phase selection, because of its small tripping area. To obtain these characteristics, relays are designed to use current or voltage information in amplitude or phase comparator e.g. the MHO characteristics can be constructed using voltage information in phase comparator as shown in Fig. 2.

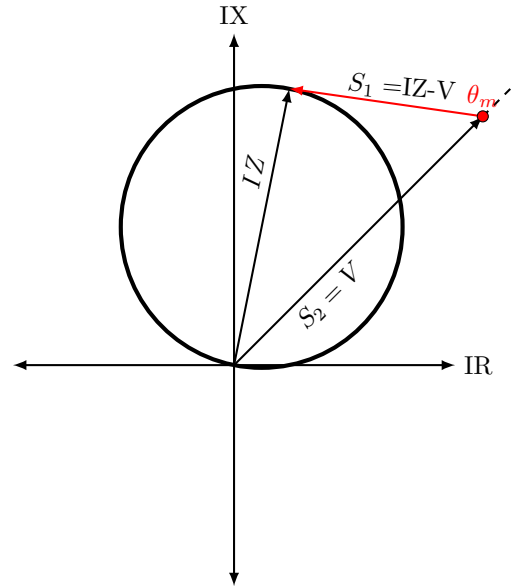

Fig. 2: MHO Characteristics - self polarized

Fig.3 shows the dynamic MHO for forward faults when different polarizing information other than self is used for S_2 .

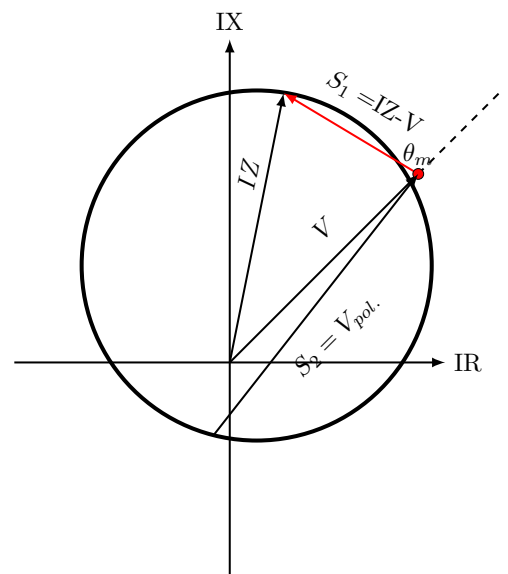

Fig. 3: MHO Characteristics - polarized with voltage information other than self

Equation 1 and 2 shows the inputs (S_1 and S_2) to the phase comparator which can be used to produce trip signal when θ_m is less than 90 degree.

$$S_1 = IZ - V \quad (1)$$

$$S_2 = V_{pol}. \quad (2)$$

where, V_{pol} is the polarizing reference which can be,

- self polarized (Fig. 2),
- polarized using sequence or sequence memory information,
- healthy phases i.e. cross polarization.

Fig. 3 shows the dynamic MHO characteristics when V_{pol} is other than self.

In-order to cover and provide protection for all fault types, distance relay consists of 3 ground elements and 3 phase elements which continuously monitors the protected line in case of non-switched distance relays. These elements are presented with appropriate current and voltage information so that, the faulted element estimates the positive phase sequence impedance from relay location to the fault point. This results in tripping initiated by the faulted element alone and the healthy elements remain inoperative, resulting in correct phase selection. This is important when distance relays are used to protect lines which demands single pole switching. The operation of healthy elements may result in incorrect phase selection or three pole switching leading to system stability and availability issues.

In the case of non-switched distance, as all elements are allowed to continuously monitor the protected line, the impedance presented to different elements vary and it depends upon various power system parameters and fault type. Let us take an example of phase to phase fault (BC) to visualize the impedance presented to all the six elements. Fig. 4 shows the single line diagram where the phase to phase fault occurs at point F.

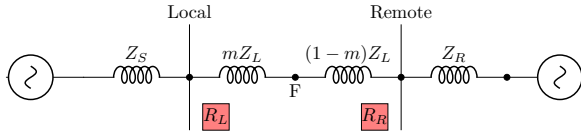

Fig. 4: Single line diagram

The corresponding sequence connection is shown in Fig. 5. With $R_F=0$, the sequence voltages at relay R_L are,

$$V_{a1} = V_{F1} + mZ_{L1}C_1I_1 \quad (3)$$

$$V_{a2} = V_{F2} + mZ_{L1}C_2I_2 \quad (4)$$

where, C_1 and C_2 are current distribution factors. Equations 3 and 4 can be rearranged as shown in equation 5.

$$mZ_{L1} = \frac{V_{a1} - V_{a2}}{C_1I_1 - C_2I_2} \quad (5)$$

Using symmetrical component transformation (equations 6 and 7), it can be observed from equation 5 that, it is nothing but the voltage and the current information presented to the BC phase distance element, which is given by,

$$\begin{bmatrix} V_0 \\ V_1 \\ V_2 \end{bmatrix} = \frac{1}{3} \begin{bmatrix} 1 & 1 & 1 \\ 1 & a & a^2 \\ 1 & a^2 & a \end{bmatrix} \begin{bmatrix} V_A \\ V_B \\ V_C \end{bmatrix} \quad (6)$$

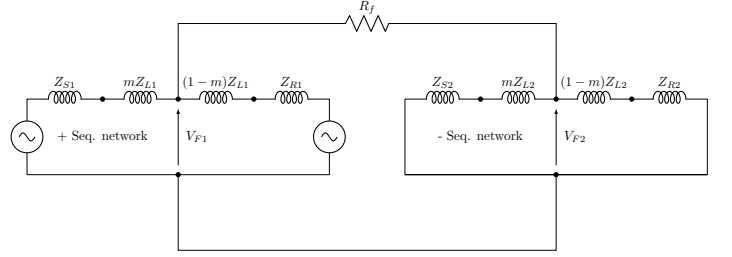

Fig. 5: Sequence connection for phase to phase fault

$$\begin{bmatrix} I_0 \\ I_1 \\ I_2 \end{bmatrix} = \frac{1}{3} \begin{bmatrix} 1 & 1 & 1 \\ 1 & a & a^2 \\ 1 & a^2 & a \end{bmatrix} \begin{bmatrix} I_A \\ I_B \\ I_C \end{bmatrix} \quad (7)$$

$$mZ_{L1} = \frac{V_b - V_c}{I_b - I_c} \quad (8)$$

Thus phase distance element BC correctly estimates the BC phase fault. Using, similar approach and considering unloaded system, the impedance estimated by the healthy ground and phase elements can be analytically obtained and the same is shown in Table I.

TABLE I: Analytical expression for healthy phase relays for a phase to phase fault (BC)

Element	Voltage	Current	Expression
AG	V_A	$I_A + kI_0$	∞
BG	V_B	$I_B + kI_0$	$mZ_{L1} + \frac{mZ_{L1} + Z_{s1}}{\sqrt{3}} \angle -90^\circ$
CG	V_C	$I_C + kI_0$	$mZ_{L1} + \frac{mZ_{L1} + Z_{s1}}{\sqrt{3}} \angle 90^\circ$
AB	$V_A - V_B$	$I_A - I_B$	$mZ_{L1} + (mZ_{L1} + Z_{s1})\sqrt{3} \angle -90^\circ$
BC	$V_B - V_C$	$I_B - I_C$	mZ_{L1}
CA	$V_C - V_A$	$I_C - I_A$	$mZ_{L1} + (mZ_{L1} + Z_{s1})\sqrt{3} \angle 90^\circ$

These can be graphically plotted [3], to understand the behavior of healthy and faulted elements. Fig. 6 shows the performance of ground and phase loop for BC fault.

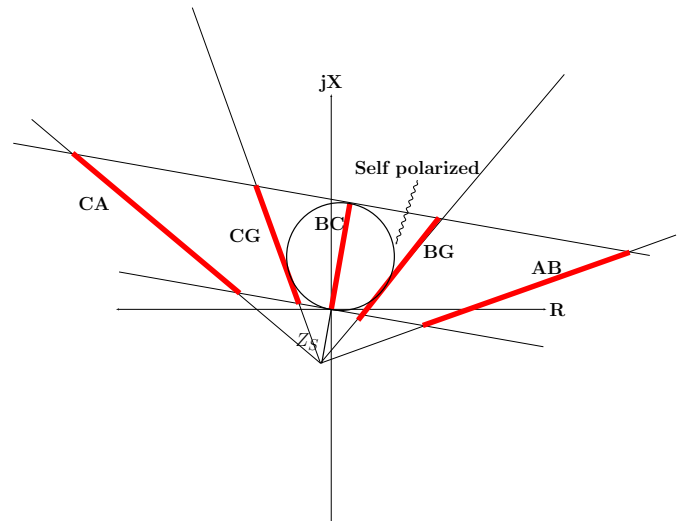

Fig. 6: Phase to ground and phase to phase element performance for phase to phase fault (BC)

Although, it looks like self-polarized gives better inherent phase selection, this is not true as the expressions in Table I is valid for $R_F = 0$. Using similar approach, the expressions can be further complicated by adding fault resistance and it can be observed that healthy elements are prone to mal-operate in the presence of fault resistance which is shown in Fig. 7.

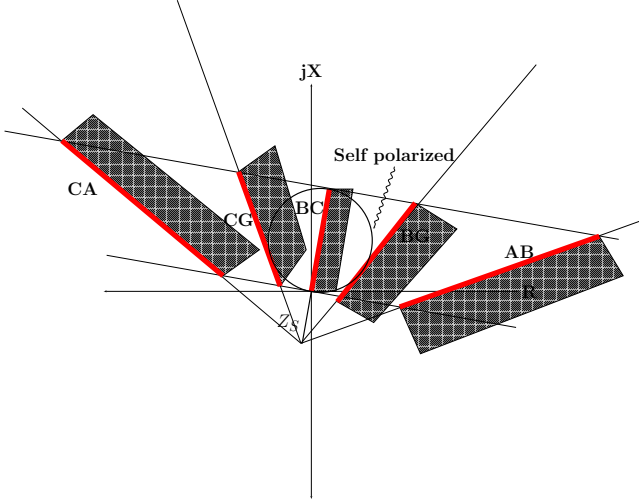

Fig. 7: Phase to ground and phase to phase element performance for phase to phase fault (BC) with fault resistance

Moreover, self-polarized MHO is seldom used as they are unreliable for zero-voltage faults and does not provide enough resistive coverage especially for short lines. Fig. 8 shows the impedance estimated by ground and phase elements with fault resistance and it can be observed that in the presence of positive sequence polarization with memory, multiple MHO elements (BG and CG) are prone to operate for phase to phase fault (BC) resulting in the operation of healthy elements and phase selectivity cannot be achieved. Similar analysis can be extended to other fault types.

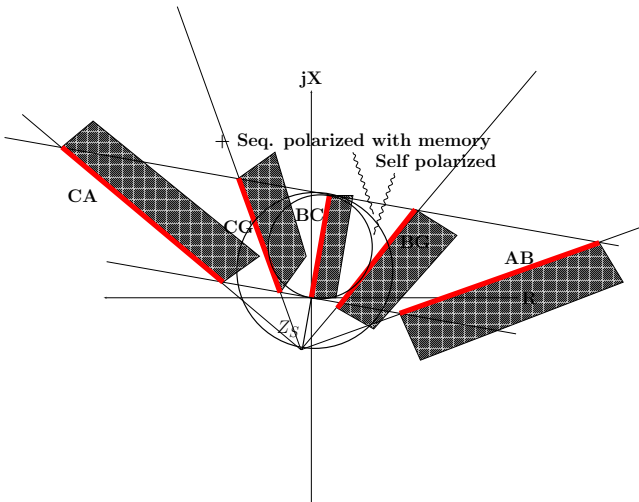

Fig. 8: Phase to ground and phase to phase element performance for phase to phase fault (BC) in the presence of fault resistance with positive sequence memory polarization

This signifies the necessity of phase selector to supervise

distance elements when the single pole switching is required to correctly detect and isolate the faulted phase. In the next section, Section III, we discuss different phase selector approaches and their theory followed by the challenges involved in detecting cross-country faults and phase selector improvements to correctly detect cross-country faults to assist single pole switching in Section IV and Section V. This is also important in the case of switched distance where the phase selector decides which element to run based on the fault type.

III. PHASE SELECTOR

A. Overcurrent based phase selection

This is the simplest and the obvious way to detect faulted phase. However, it suffers from the following drawbacks,

- Threshold needs to be adapted to accommodate temporary overloading especially for parallel lines
- Weak source results in significantly low short circuit currents resulting in sensitivity issues
- Fault current limited by resistance or reactance also results in low short circuit currents

B. Voltage based phase selection

Another option is to use voltage information for phase selection. The faulted phase is expected to cause a significant voltage drop. However, the source and fault impedance have an impact on the voltage available at the relay e.g. high resistance ground fault will not result in significant voltage drop, as a result, it does not provide adequate sensitivity.

C. Phase selection using wave information

The high frequency information embedded in the fault signature immediately after the fault provides an opportunity to extract and utilize high frequency information for detecting the faulted phase. However, as the focus of this paper is on cross-country faults, the discussion is limited to fundamental frequency information.

D. Delta quantities based phase selection [4]

The approach here utilises delta quantities based on fundamental frequency information and phase selection can be achieved by comparing the magnitudes of the three phase-to-phase superimposed currents, obtained using the following equations,

$$\Delta I_X = I_X - I_{X,pre-fault} \quad (9)$$

$$\Delta I_Y = I_Y - I_{Y,pre-fault} \quad (10)$$

$$\Delta I_{XY} = \Delta I_X - \Delta I_Y \quad (11)$$

where, X and Y are representing any pair of phases A, B and C. The super-imposed phase-phase information can be compared to the threshold to make a high-speed decision on the faulted phase to assist high speed distance relays.

1) *Phase to ground fault*: In this case, the superimposed information i.e. magnitude will be same on two signals, but in phase opposition, whereas the third information will be zero. This is shown in Fig. 9(a).

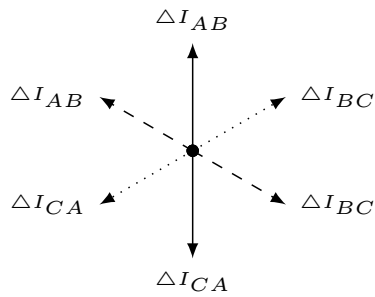

(a) Phase to ground faults AG- Solid, BG-dahsed, CG-dotted

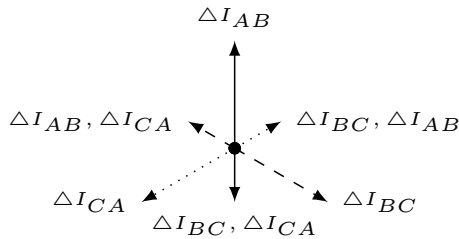

(b) Phase to phase faults AB- Solid, BC-dahsed, CG-dotted

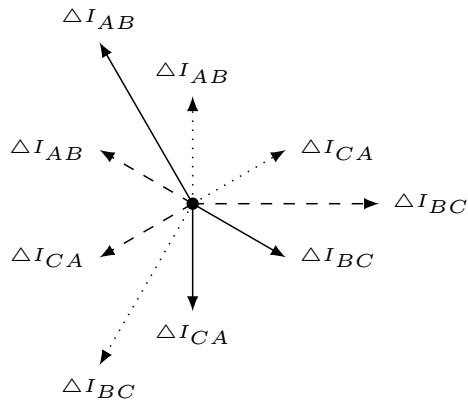

(c) Phase to phase to ground faults ABG- Solid, BCG-dahsed, CAG-dotted

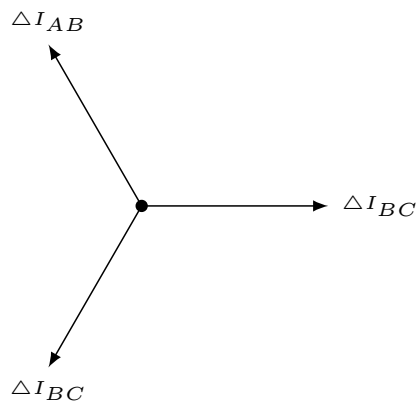

(d) Three phase fault

Fig. 9: Phase selector based on Delta Quantities

2) *Phase to phase fault*: In this case, the magnitude information of one signal will be higher than the other two and will be 180 degree apart as shown in Fig. 9(b).

3) *Phase to phase to ground fault*: This is similar to phase to phase fault, but the signals with smaller magnitude will not be in phase. This is shown in Fig. 9(c).

4) *3 phase fault*: All the signals will have equal magnitude equally displaced by 120 degree as shown in Fig. 9(d).

E. Phase selection using sequence information

The idea of comparing sequence angle information was first proposed in 1942 [5]. The initial approach as shown in Fig. 10 was to compare the angle between negative sequence and zero sequence current information in electromechanical relays using appropriate sequence filters to achieve phase selection for single pole switching. This is due to the fact that the zero sequence information is expected to be in phase with the faulted phase.

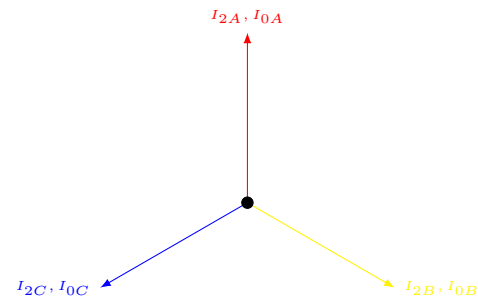
Fig. 10: Phase selector by comparing I_2 and I_0 , Red- AG fault, Yellow-BG fault and Blue - CG fault

This information can be used to assist distance to achieve single pole switching. However, during phase to phase fault, 3 phase fault, zero sequence information will not be available and this plane alone cannot be relied to detect all the following fault types,

- AG, BG, CG
- AB, BC, CA
- ABG, BCG, CAG

This led to the use of additional plane where negative and positive sequence current information are used in parallel with negative and zero sequence current information to decide the fault type. One of the major advantage [6], is the speed of detection as the negative and zero sequence information becomes significant as the window gets filled with fault information. In order to achieve overall speed, the speed of detection in Pos. vs Neg. sequence plane can be increased by widening the angle band. The use of two sequence plane is the added advantage, as one plane inherently acts as a security for other plane and vice versa. This avoids the necessity of having security counters to improve reliability, thereby making the decision faster without compromising reliability. This is highly important for distance relays with sub-cycle operating times, where reliable high-speed phase selection is needed to supervise distance.

Table II shows the angular relationship between sequence information in both planes which can be obtained using equation 7, e.g. if both zero sequence current and negative sequence current are in-phase and negative sequence current and positive sequence current are in phase then AG phase is decided as the faulted phase. Threshold checks are applied to negative and zero sequence information to ensure that the angle checks are done during the fault.

TABLE II: Sequence components relation in sequence planes

Fault Type	I_2 Vs I_1 Plane	I_2 Vs I_0 Plane
AG Fault		
BG Fault		
CG Fault		
AB Fault		-
BC Fault		-
CA Fault		-
ABG Fault		
BCG Fault		
CAG Fault		

Fig. 11(a) and Fig. 11(b) shows the sequence planes with bell shaped regions, which are constructed using the information from Table II.

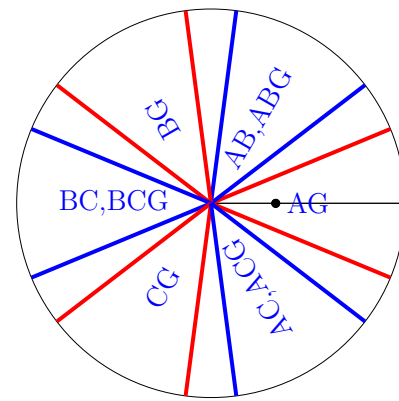

(a) 'Neg. Seq' vs 'Pos. Seq' plane

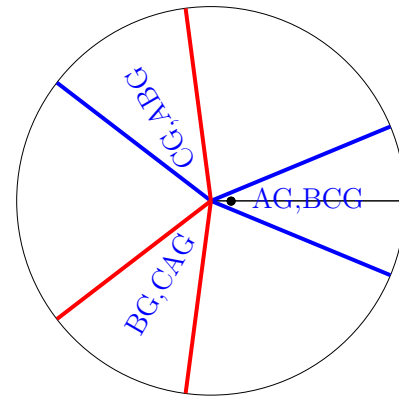

(b) 'Neg. Seq' vs 'Zero. Seq' plane

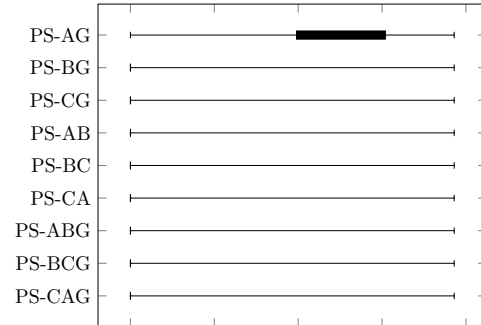

(c) Phase selector flags

Fig. 11: Single phase to ground fault

Phase selection decision is made using both the planes, i.e., when both the sequence plane are in agreement e.g. let's consider a AG fault (F) in Fig. 4, it can be observed from Fig. 11(a) and Fig. 11(b) that, both planes detect AG/BCG as the fault type, but since AG is agreed by both planes, PS-AG gets asserted (Fig. 11(c)). Using the same approach, when we have phase to phase to ground fault, ABG (F) in Fig. 4, the corresponding trajectories are shown in Fig. 13(a) and Fig. 13(b) and it can be observed that both planes detect and agree common fault type ABG.

However, when we have phase to phase fault, zero sequence information will not be available and the decision has to be made with one plane only, this can be observed when we have

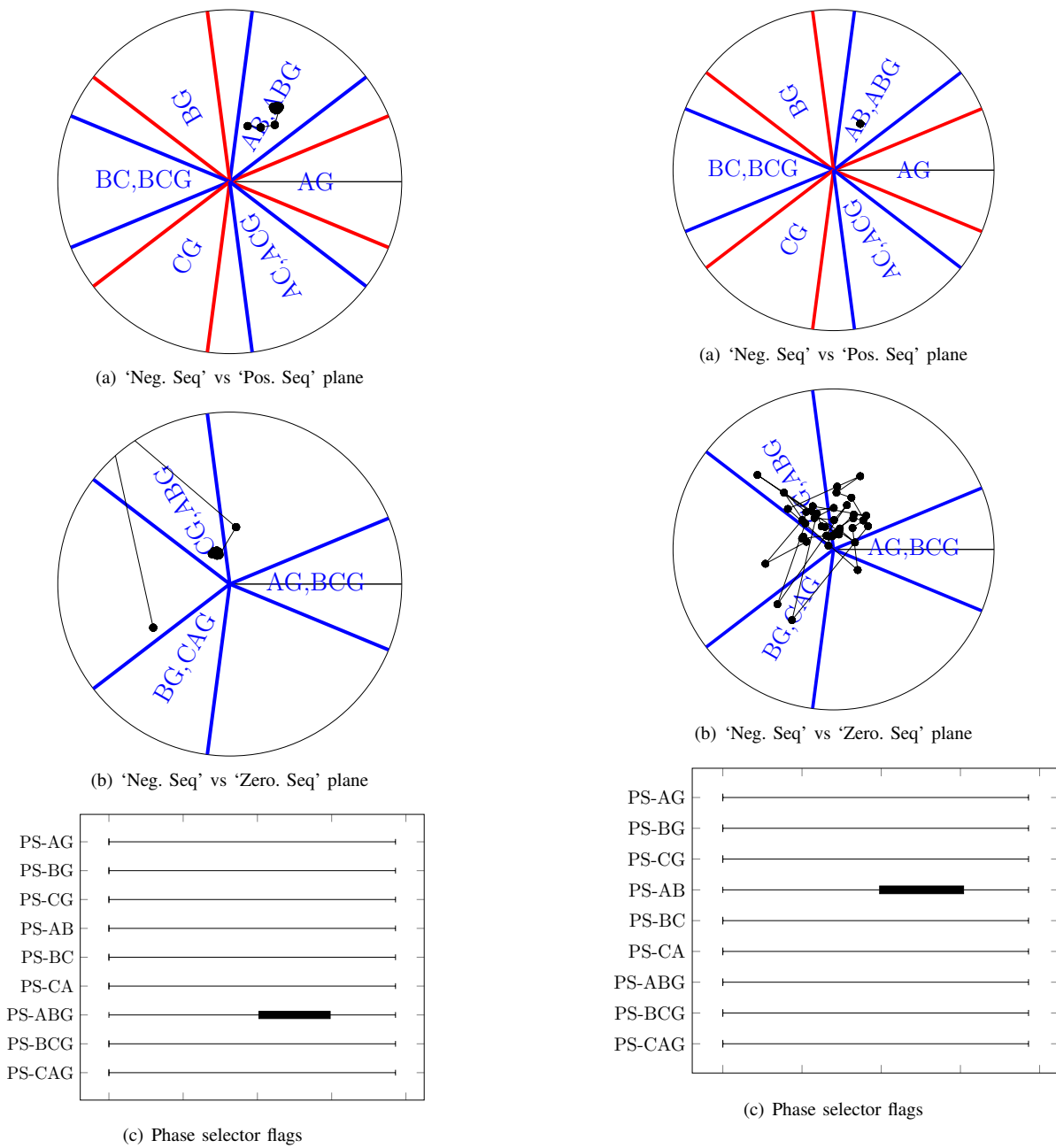

Fig. 12: Phase to phase to ground fault

a phase to phase fault AB (F) in Fig. 4. Fig. 13(c) the Neg. vs Pos. sequence plane correctly detects the fault type and Zero Vs Neg. sequence plane will not be in agreement with the other plane.

As mentioned earlier, the increased angle bounds to improve the speed of the pos. vs neg. sequence plane may cause reliability issue for detecting phase to phase faults with one plane alone and without any security strategy. This is overcome by introducing adaptive angle limits based on the sequence information available. The above approach is also applicable to voltage based sequence information.

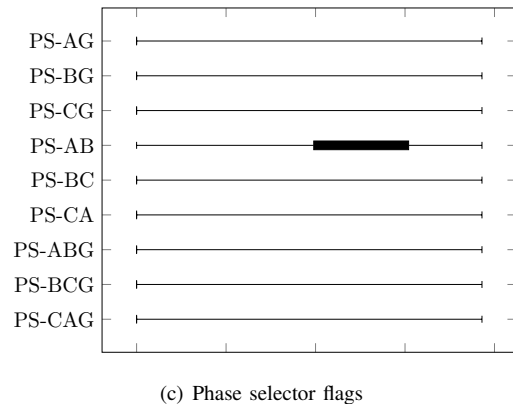

Fig. 13: Phase to phase fault

IV. CROSS COUNTRY - SOLID GROUNDING

Cross country faults are simultaneous or evolving faults involving multiple phases at two different line sections. Although, cross country faults occur rarely in solid grounded systems,

- it poses a significant risk to system stability, as maloperation of distance may cause system separation leading to cascaded trippings which may even result in blackouts
- it can mislead maintenance team, as the second fault would have been left unattended while bringing back the line to service.

In order to understand the impact of cross country faults on distance, let's consider a system as shown in Fig. 14, where

we have two single phase to ground faults at F_1 and F_2 . Lets assume AG fault occurs at F_1 and AG/BG/CG occurs at F_2 .

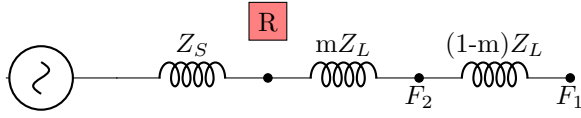

Fig. 14: Single line diagram - Cross country fault

Using equation 7, we have the following at F_2 ,

- AG fault ($K_2 = 1, K_0 = 1$)

$$I_1 = K_2 I_2 = K_0 I_0 \quad (12)$$

- BG fault ($K_2 = \alpha^2, K_0 = \alpha$)

$$I_1 = K_2 I_2 = K_0 I_0 \quad (13)$$

- CG fault ($K_2 = \alpha, K_0 = \alpha^2$)

$$I_1 = K_2 I_2 = K_0 I_0 \quad (14)$$

The sequence connection for the above mentioned cross country fault scenario is shown in Fig. 15, where the AG/BG/CG fault is connected via ideal transformers with unity magnitude to handle phase shift. Applying KVL to left side loop connecting the three sequence network, equation 15 can be obtained, using equation 12 or 13 or 14 respectively. This is true for any fault type at F_1

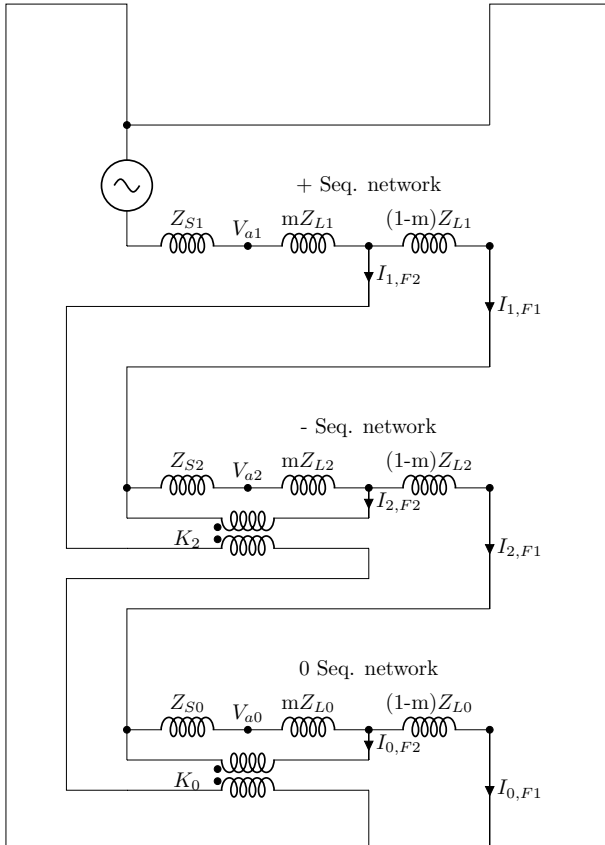

Fig. 15: Sequence Connection- Cross country fault

$$mZ_{L1} = \frac{V_r}{I_r(1+k)} \quad (15)$$

From equation 15 it can be inferred that, the fault which is closer relative to the other fault with respect to the relay location will be estimated/seen correctly. The other fault which is relatively far from the relay location will have errors in impedance estimation. This can be estimated analytically by considering the above scenario i.e. $V_a=0$ at F_1 which results in equation 16.

$$V_{1,F1} + V_{2,F1} + V_{0,F1} = 0 \quad (16)$$

From Fig. 15 equation 16 can be simplified to estimate the error term which is shown in equation 17

$$\frac{V_r}{I_r(1+k)} = Z_{L1} - \underbrace{(1-m)Z_{L1} \frac{I_{r,F2}}{I_r}}_{error} \quad (17)$$

The following observations can be made from equation 17,

- when $m = 1$, it is basically phase to phase to ground fault and no longer cross country and it can be observed that error term boils down to zero.
- when fault at F_1 is removed, then basically its not a cross country fault and we have only one fault and $I_{r,F2} = I_r$. Using this relation in equation 17 yields correct estimation (mZ_{L1}) for AG fault
- when the two faults move apart then the error term varies, this can be observed from simulation studies where AG fault at F_1 is fixed at 90% of line length and BG/CG fault F_2 is moved from 80% to 10% of line length. The impedance loci is shown in Fig. 16, which shows that BG/CG fault is esitmed correctly as it is relatively near the relay location and the other fault AG(cross marker, BG moved towards relay location), AG (circle, CG moved towards relay location) invovles impedance estimation errors.

The above analysis is also extended to observe the phase element performance during cross country fault. Fig. 17 shows the performance of phase elements for the earlier case where AG fault was fixed at 90% of line length and BG fault was moved from 90% to 10% of line length. It can be observed that, zone 1 phase element AB is prone to operate as BG fault is moved closer to the relay location. Similarly, BC element is also vulnerable based on the polarization used in the relay.

Fig. 18 shows the performance of phase elements for the second case, where AG fault was fixed at 90% of line length and CG fault was moved from 90% to 10% of line length towards relay R. Similar behavior is observed, where zone 1 phase element CA is prone to operate as CG fault is moved closer to the relay location and BC element is vulnareable based on the relay polarization.

Thus for both the considered cross-country scenarios, zone 1 phase elements are prone to operate. Now, when we consider the fault F_1 in Fig. 14 to be in adjacent line close to the bus, although down stream relays will be handling the fault F_1 , the upstream relays which sees both forward faults F_2 and F_1

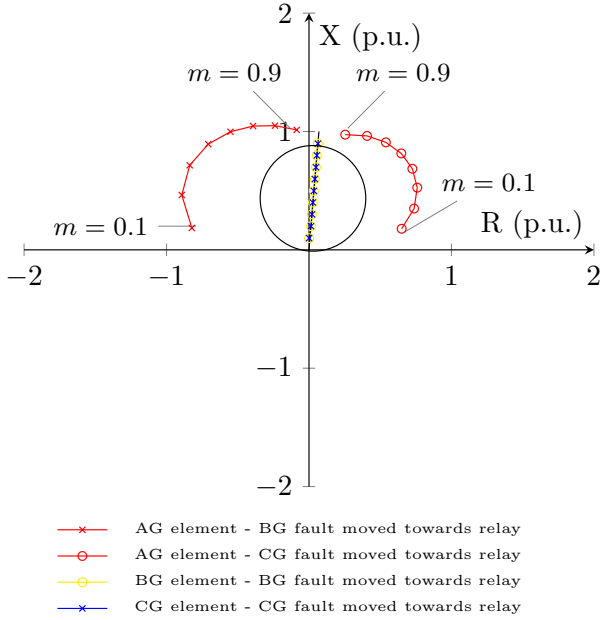

Fig. 16: Ground Elements - Cross country fault $F_1 = AG$, $F_2 = BG/CG$

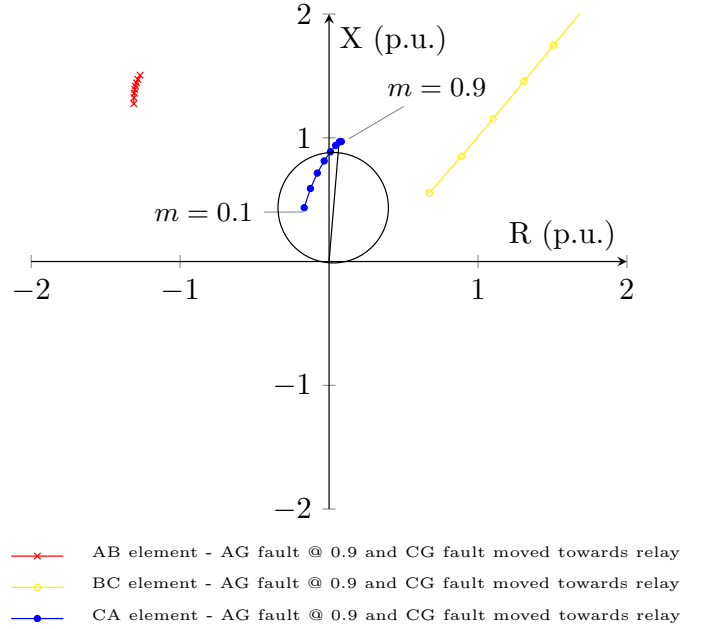

Fig. 18: Phase Elements - Cross country fault (AB- cross, BC- circle, CA- circle filled)

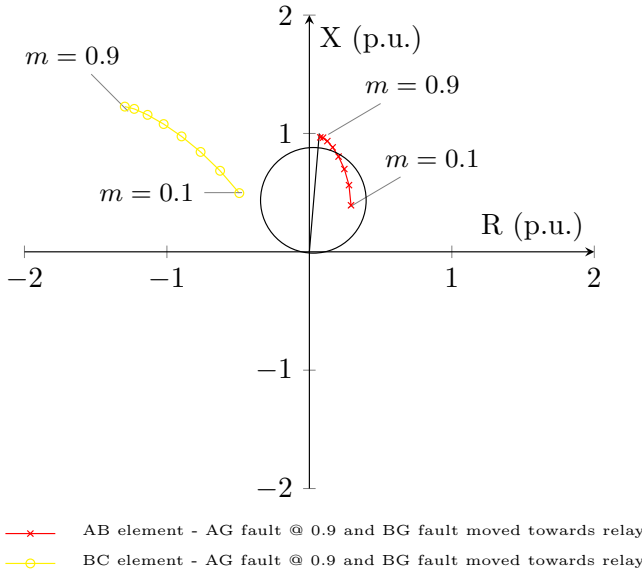

Fig. 17: Phase Elements - Cross country fault $F_1 = AG$, $F_2 = BG/CG$

may result in operation of Zone 1 phase elements leading to 3 pole tripping which is not desired.

This is also applicable to parallel lines Fig. 19, [7],[8],

- In the absence of mutual coupling and with single in-feed
 - R_1 and R_3 measures correctly
- In the presence of mutual coupling and with single in-feed and mutual compensation
 - R_1 measures correctly
- In the presence of mutual coupling and with remote end in-feed and mutual compensation
 - R_1 and R_4 measures correctly when $m < 0.5$

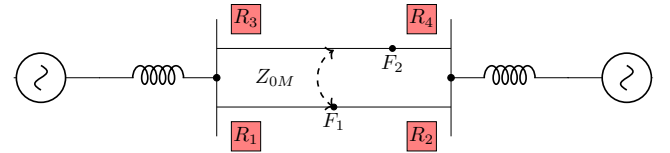

Fig. 19: Cross country fault on double circuit line

Phase selection plays a crucial role in these scenarios to supervise distance elements and correctly assist tripping the faulted phases of the protected zone, provided phases are detected correctly. The next section discusses the behavior of phase selection under such scenarios.

V. PHASE SELECTOR CHALLENGES AND IMPROVEMENTS - LABORATORY TESTING

Lets consider a cross country fault, two single line to ground faults at different location as shown in Fig. 20. The first fault AG (F_1) is on the adjacent line which evolves into second fault BG F_2 after 20ms on the protected line at 60% from R_2 .

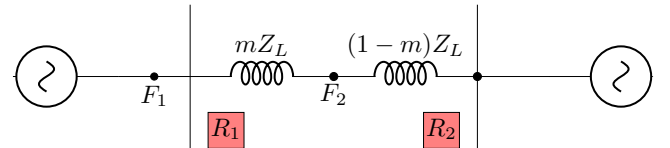

Fig. 20: Single line diagram - Cross country fault

Fig. 21(a) shows the current signal traces for the cross-country fault and Fig. 21(b) shows the phase selector decision based on the sequence plane information. Relay R_1 provides wrong phase selection for this cross-country fault which cannot be used to supervise distance at R_1 using local information.

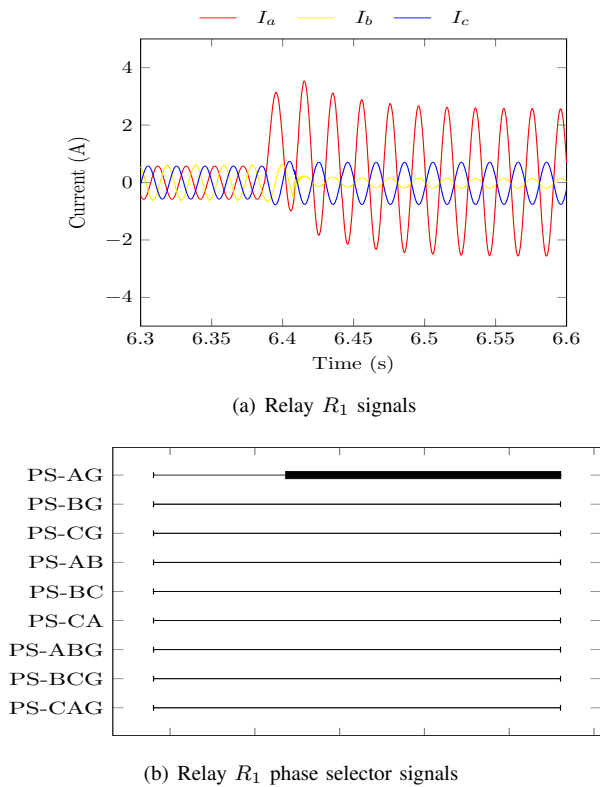

Fig. 21: Relay R_1 event recorded for a cross country fault $F_1 = AG$ and $F_2 = BG$

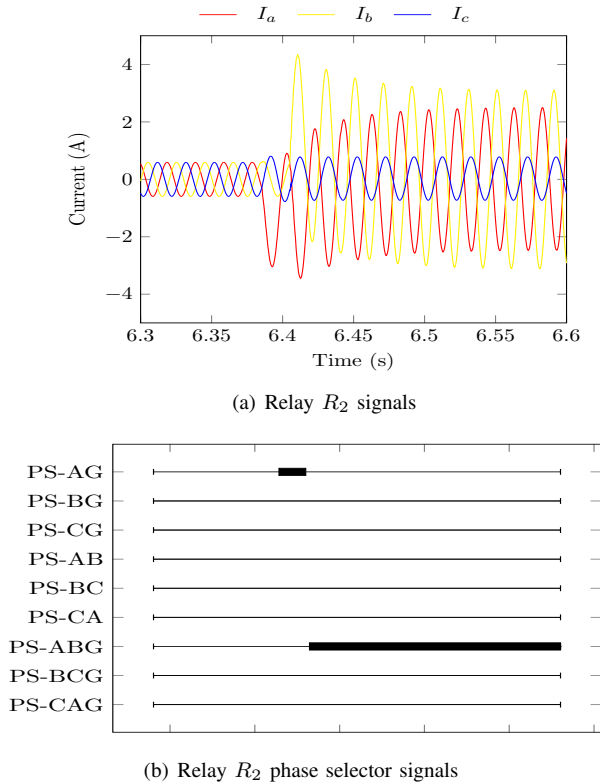

Fig. 22: Relay R_2 events- cross country fault $F_1 = AG$ & $F_2 = BG$

When we look into the relay R_2 response Fig.22, which looks both faults in forward direction, the phase selector switches from AG to ABG when the fault evolves. Although, the phase selector is able to detect the phases involved in the fault correctly, it has no information whether the fault is a actual phase to phase to ground fault or cross country fault. The ABG indication seems to be logically correct, as we have two single phase to ground faults AG and BG both in forward direction. However, the phase selector cannot be ideally used to supervise zone 1 distance, as this may result in phase element operation instead of ground element. To overcome this, communication assisted phase selection was introduced [6], where remote end phase selection information is made available in the form of additional bits. This is utilized by the other end relay to decide the phase correctly, provided one relay detects the cross-country fault correctly. However, in this case, correct single pole switching cannot be achieved.

Now, lets see an another case, to understand the limitation of communication assisted phase selector decisions. Let's consider the system similar to Fig. 20, but now with parallel line which is shown in Fig. 19 and let's consider a cross-country faults, F_1 AG fault very close to R_2 and F_2 ABG fault very close to R_4 . Fig. 23 shows the relay R_2 signals.

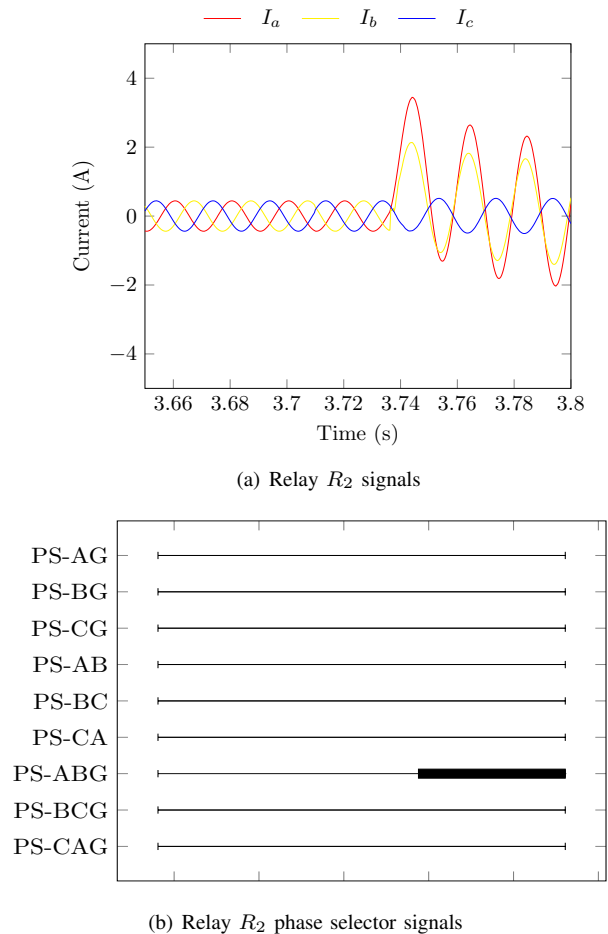

Fig. 23: Relay R_2 events- cross country fault $F_1 = AG$ & $F_2 = ABG$ (Fig. 19)

Ideally, relay R_3 and R_4 should isolate the line with fault

F_2 by issuing a 3 pole trip and relay R_1 and R_2 should issue single pole trip in A ph on the line with fault F_1 so that system split does not happen. As we have already seen earlier that, the relay which looks both faults in forward goes for ABG selection which is true for this case also, where relay R_1 makes ABG as phase selector decision and it entirely depends on the relay R_2 decision to achieve single-pole switching with communication assisted phase selection. Fig. 23(b) shows Relay R_2 makes ABG decision instead of AG, which results in 3 pole switching i.e. even with communication assisted phase selection, 1 pole switching is a challenge.

A. Phase selector improvements

The use of overreaching zones for phase selection is not uncommon [4] and it can be used to identify the phases involved in the ground faults, i.e. it can be a phase to phase to ground or cross-country faults. The outputs of the symmetrical components based phase selector is then used along with the outputs from overreaching zones and these are switched dynamically based on the detection of cross-country faults. Fig. 24 shows the simplified logic diagram, where upon detection of any disturbance will open up window of certain duration to detect cross-country faults. The approach here, utilizes the local information without relying on communication medium to make a decision on phase.

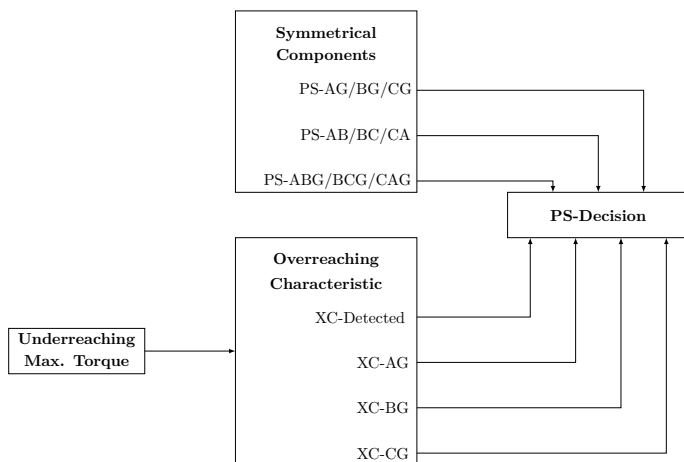
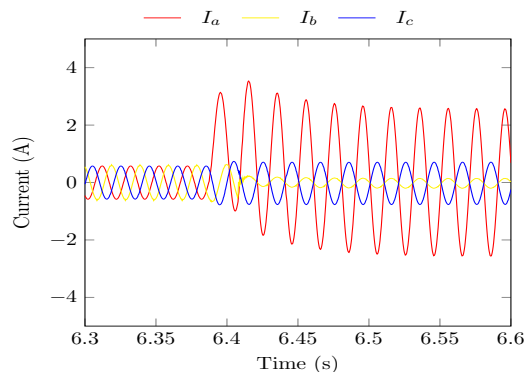
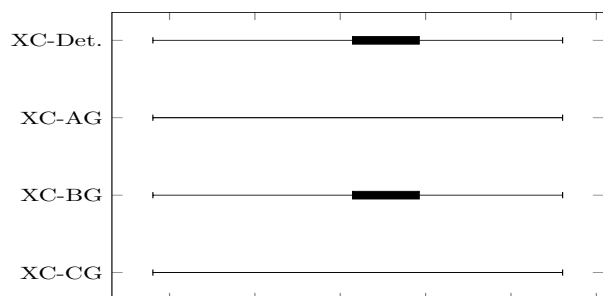

Fig. 24: Composite application of overreaching impedance and symmetrical components based phase selector

1) *Single line - Cross country fault*: For the earlier case i.e. cross-country fault AG (F_1) and BG (F_2) (Fig. 20) we have seen that correct 1 pole switching is only achievable at relay R_2 using remote end information provided, relay R_1 identifies the phase correctly. Fig. 25(b) and Fig. 26(b) provides the relay events which shows that both relays R_1 and R_2 were able to detect the presence of cross-country faults and in addition to that, relay R_2 detects the faulted phase in the protected zone correctly without using the remote end information i.e. relay R_1 . Additionally, in the earlier case, relay R_2 would have signaled ABG fault to the remote relay R_1 , however, in the presence of composite phase selector, correct signal has been exchanged by both relays, which can be used for any other purpose locally, if necessary.



(a) Relay R_1 signals



(b) Relay R_1 cross country phase selector signals

Fig. 25: Relay R_1 event recorded for a cross country fault $F_1 = AG$ and $F_2 = BG$

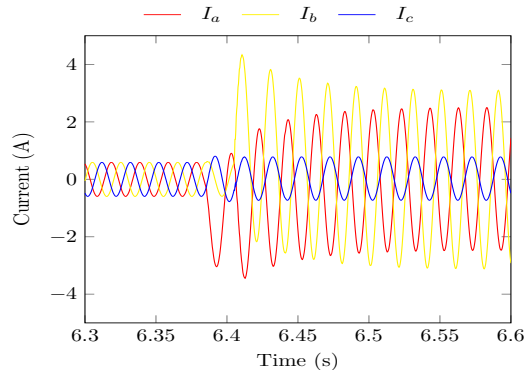

(a) Relay R_2 signals

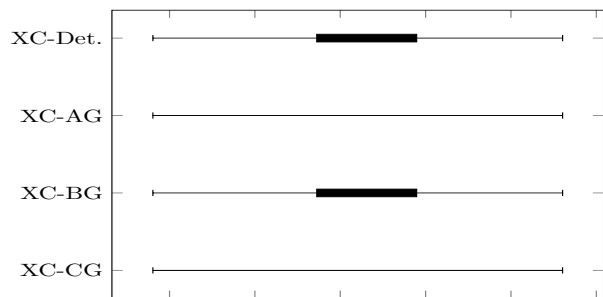

(b) Relay R_2 cross country phase selector signals

Fig. 26: Relay R_2 events- cross country fault $F_1 = AG$ & $F_2 = BG$

2) *Parallel line - Cross country fault*: Earlier discussions have shown that for cross country fault $F_1 = AG$ & $F_2 = ABG$ (Fig. 19), system split can be avoided if relay R_2 correctly decides the phase for the considered cross country fault. Fig. 27(b) shows the relay events, where it is observed that relay R_2 correctly decides the faulted phase of the protected line. Although, relay R_1 is expected to decide ABG as both AG and ABG faults are in forward direction, the decision of composite phase selector dynamically switches the phase selector information which is communicated to relay R_1 , as a result both ends of the line attempts for a 1 pole-trip in A phase, avoiding system split, which may lead to cascaded tripping.

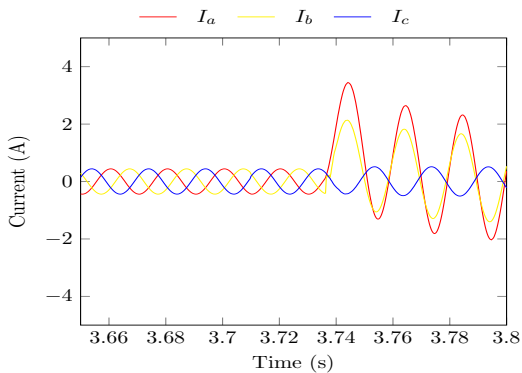

(a) Relay R_2 signals

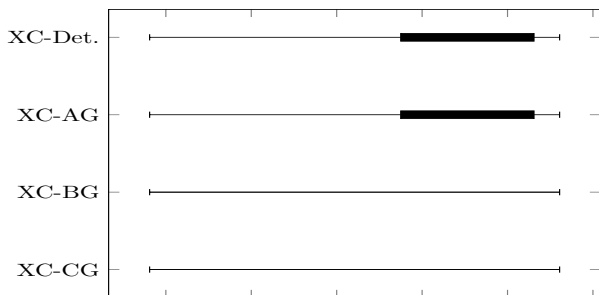

(b) Relay R_2 cross country phase selector signals

Fig. 27: Relay R_2 events- cross country fault $F_1 = AG$ & $F_2 = ABG$ (Fig. 19)

VI. CROSS COUNTRY FAULTS - ISOLATED/COMPENSATED SYSTEMS

Although rare, Isolated/Compensated systems are still in use and these are beneficial in locations where there is high probability of transient faults. As the neutral is isolated or earthed via a reactor, the response of the isolated/compensated systems for faults involving ground will not be similar to solid grounded systems. For an ideally tuned reactor the earth fault current is almost negligible for a single phase to ground fault, however, small amount of earth fault current can flow due to any change in system capacitance, if reactor is not following i.e. tuned to changes in system capacitance.

A. Single phase to ground faults

During single phase to ground faults, the voltage of the faulted phase collapses to zero across whole of the galvanically connected network (Fig.28(b), Fig.30(a)), whereas in solid grounded system, this is true only at the fault location provided it is a bolted fault. This is shown in Fig. 28(a) where the available voltage information increases when we move towards the source. Although the faulted phase voltage is zero, the voltage triangle still remains balanced with shifted neutral in isolated/compensated system (Fig.28(b)). Additionally, the fault will self-extinguish due to low fault currents. This is shown in (Fig. 30(b)). Most of the single phase to ground faults (around 80% [4]) will self-extinguish, whereas in solid grounded systems the fault current magnitude will be higher.

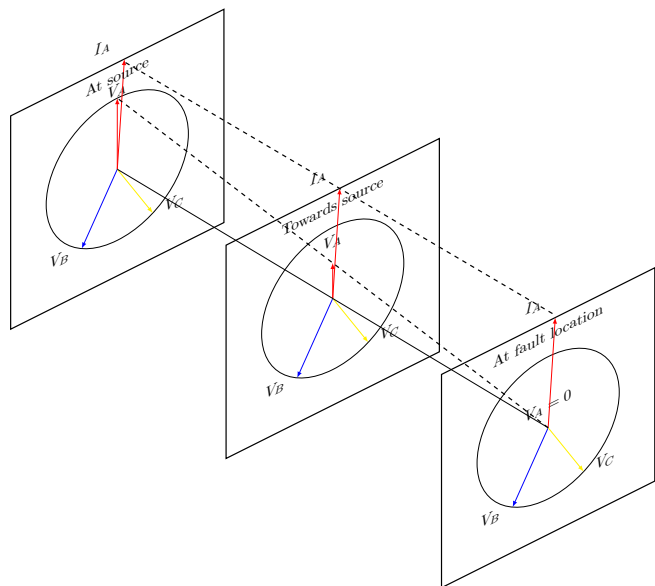

(a) Solid grounded systems - single phase to ground fault

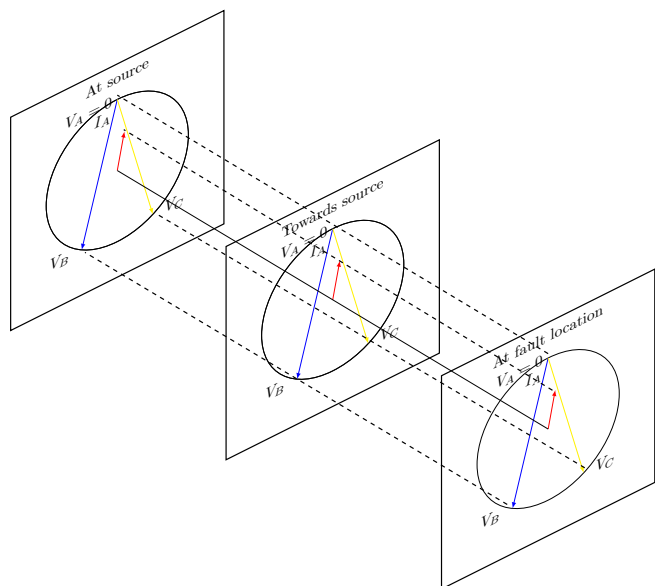

(b) Isolated/Compensated systems - single phase to ground fault

Fig. 28: Fault information across the line for AG fault

As a result, instantaneous tripping should not happen and system is allowed to remain connected providing uninterrupted supply, which makes this system popular. In order to block distance protection during this fault, detection of first ground fault is done by monitoring neutral current and/or neutral voltage (Mode selector) to overcome false detection during current transformer saturation as shown in Fig. 29. Single pole (1P) time delay is used to prevent incorrect detection during single phase to ground faults, as the initial half-cycle after the fault inception may have current amplitude higher than the nominal current, with a frequency close to the nominal system frequency.

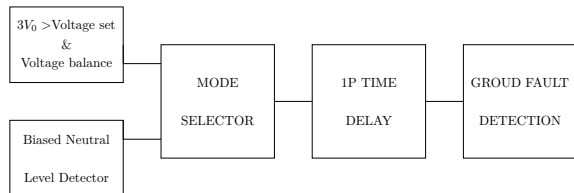
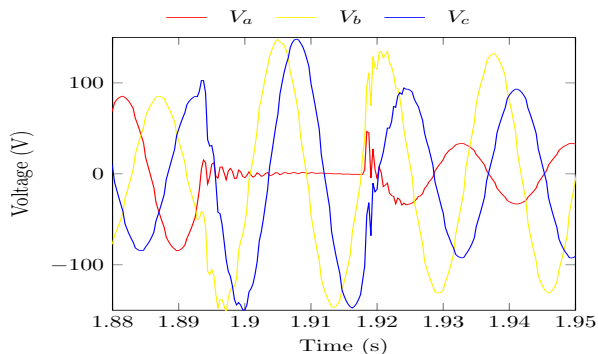
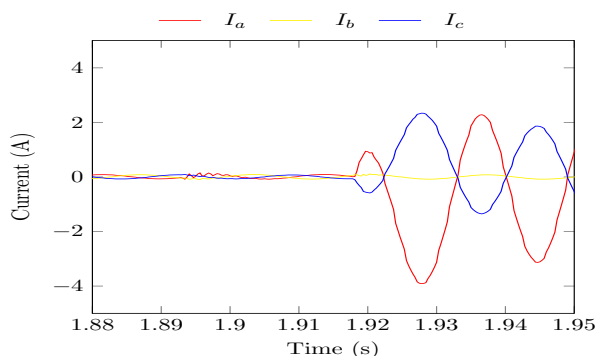

Fig. 29: First ground fault detection

The presence of single phase to ground fault is expected to cause increase in healthy phase to ground voltages by a factor of $\sqrt{3}$ as shown in Fig.30(a). Although, the system is designed with additional insulation, this may result in an other single phase to ground fault in any of the healthy phases, elsewhere in the system i.e. cross-country fault.



(a) Voltage signals



(b) Current signals

Fig. 30: Compensated System - First fault and during cross country fault

B. Cross-Country faults

Unlike solidly grounded system, the probability for cross-country faults in isolated/compensated systems are more. This is because the second fault will occur on the healthy phase as the voltage on the faulted phase has collapsed to zero and the healthy voltage has increased by a factor of $\sqrt{3}$ making it more prone to insulation failure. The main difference with respect to solid grounded systems is, in the case of solid grounded systems, both phases involved in cross-country faults needs to be isolated, whereas in isolated/compensated systems, only one of the phases involved in cross-country faults is sufficient. This opens up multiple options to trip the phase based on the priority and one such option is shown in Table III.

TABLE III: Phase Priority Tripping

Selection	Priority	Loops	Selected Phase
C(A) acyclic	C before A, A before B	AG, BG	AG
		BG,CG	CG
		CG,AG	CG
		AG,BG,CG	CG

Depending upon the phase priority and faulted loops, a particular section of system i.e. line is isolated instead of isolating the faulted phases of the line which is the case for solid grounded systems.

Fig. 32(a) and Fig. 32(b) shows the voltage and current signals for a cross country fault AG and CG at F_2 and F_3 respectively (Fig. 31).

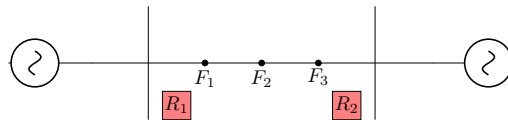

Fig. 31: Cross Country fault - Isolated system $F_2 = AG, F_3 = CG$

First ground fault is detected based on the neutral current and/or neutral voltage as discussed earlier and it is used to block the phase distance during cross country faults. The second fault is confirmed, when the following conditions are satisfied,

- First fault detected
- phase to phase voltage triangle is unbalanced
- neutral voltage has exceeded the set threshold
- neutral current has exceeded the set threshold

The phase selection here is achieved using overreaching zones. Fig. 32(c) shows the relay events with C(A) acyclic chosen for phase priority tripping. As CG and AG are the faulted loops involved in this cross-country fault, CG is selected for tripping.

C. Phase to phase faults

Faults which does not involve ground, i.e. during phase to phase faults or 3 phase faults, the expected response is similar to solid grounding systems as it does not involve ground. However, the phase elements need to be blocked when cross-country faults are detected in isolated/compensated

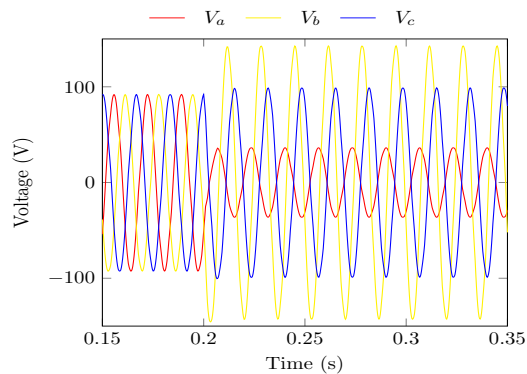

(a) Voltage signals

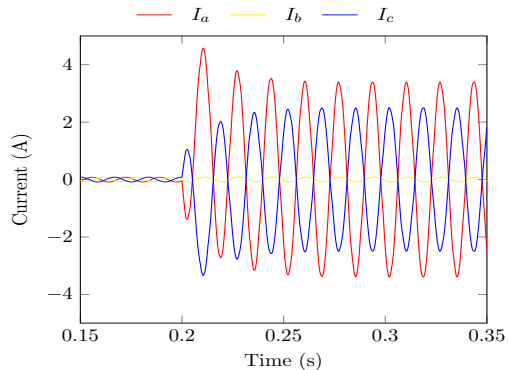

(b) Current signals

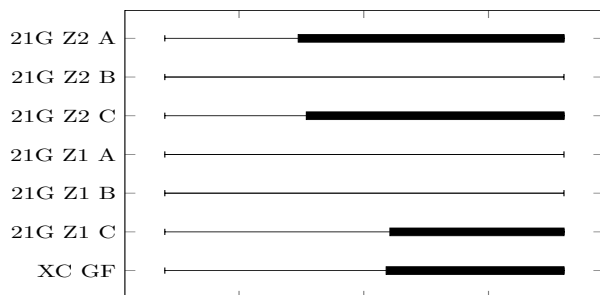

(c) Relay Events

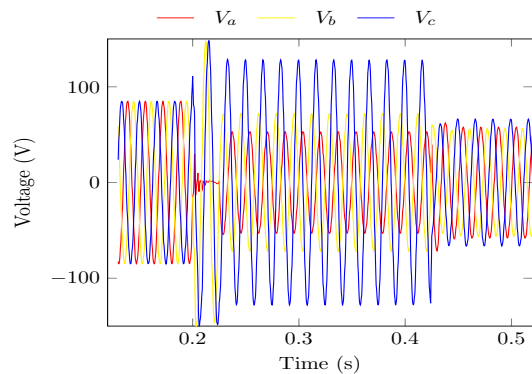

(a) Voltage signals

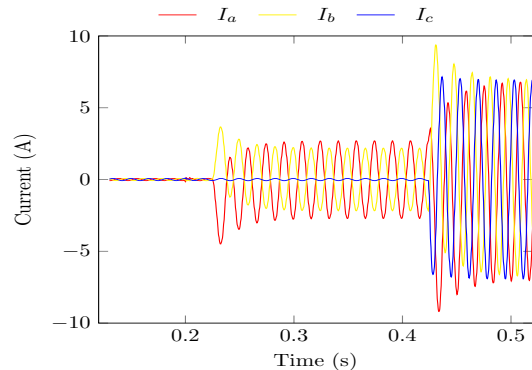

(b) Current signals

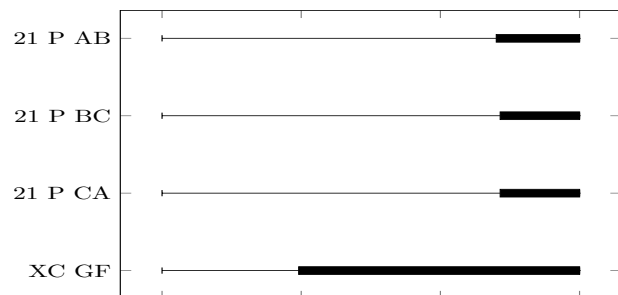

(c) Relay Events

Fig. 32: Relay events for cross country fault AG and CG with C(A) Acyclic as selection

Fig. 34: Relay events for cross country fault AG, BG followed by 3 phase fault

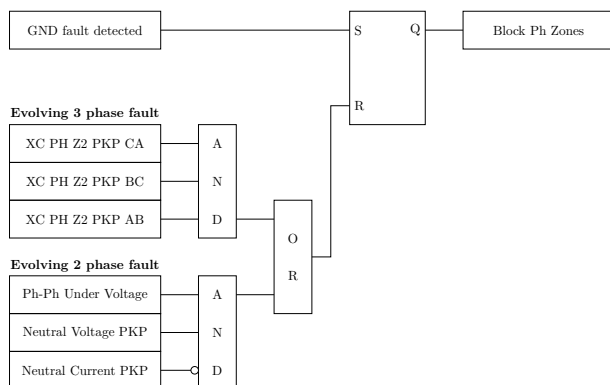

Fig. 33: Phase Zone unblocking

application, but this block needs to be reset when Evolving 3 phase fault or evolving 2 phase fault is detected.

Fig. 34(a) and Fig. 34(b) shows the voltage and current signals for the cross country faults AG and BG at F_2 and F_3 respectively, which later evolved to 3 phase fault at F_1 . Fig. 34(c) shows the relay events where the phase elements are blocked during cross-country faults and the block is later removed when evolving 3 phase fault is detected (Fig. 33).

VII. CONCLUSION

The concept of phase selection to supervise distance elements exists for almost eight decades and has evolved to precisely identify the faulted phases under different power system conditions. However cross-country faults, still pose a

challenge to today's sophisticated phase selection algorithms. In this paper we have discussed different phase selector approaches and their pros and cons in general.

In the case of cross-country faults in solidly grounded systems, multi-bit communication assisted schemes can provide correct phase selection provided, one end relay, which sees one phase to ground fault forward and another phase to ground fault in reverse direction, detects the phase correctly. This may not be true, when we have one phase to ground fault in forward and a phase to phase to ground fault in reverse direction, especially in parallel lines this may result in tripping of both lines.

This limitation is overcome by improving the phase selector with additional composite over-reaching and under-reaching zone information to detect the cross-country faults. This works along with existing phase selector and adapts the decision when cross-country is detected.

During cross-country faults, the faults closer to the relay are estimated correctly which gives added advantage to detect the cross-country faults using local information without relying on remote information. This is highly beneficial, when the use of pilot schemes or the use of multi bit communication medium cannot be justified from cost perspective.

In Isolated/Compensated system, similar approach i.e. utilizing overreaching zone information is adopted to assist the phase selection and use this information to supervise distance comparators, which are specifically designed for these applications. During cross-country faults, one of the fault is isolated based on the phase preference tripping and the loops which were involved in the cross-country faults, with the expectation that the fault at the other location will self-extinguish. As all devices across the network should follow the same phase preference tripping, the preferred phase is selected based on the fault loops involved, which decides the line which needs to be isolated from the system by three-pole tripping.

REFERENCES

- [1] J. J. Trainor, J. E. Hobson, and H. N. Muller, "High-speed single-pole reclosing," *Transactions of the American Institute of Electrical Engineers*, vol. 61, no. 2, pp. 81–87, 1942.
- [2] E. E. George, "Operating experience with reactance type distance relays," *Transactions of the American Institute of Electrical Engineers*, vol. 50, no. 1, pp. 288–293, 1931.
- [3] A. R. Van C. Warrington, "Graphical method for estimating the performance of distance relays during faults and power swings," *Transactions of the American Institute of Electrical Engineers*, vol. 68, no. 1, pp. 608–621, 1949.
- [4] *MiCOMho P443 Fast Multifunction Distance Protection*, GE, Stafford, England, 2012.
- [5] S. L. Goldsborough and A. W. Hill, "Relays and breakers for high-speed single-pole tripping and reclosing," *Electrical Engineering*, vol. 61, no. 2, pp. 77–80, 1942.
- [6] M. J. Kasztenny B, Cambell B, "Phase selection for single-pole tripping-weak infeed conditions and cross-country faults," in *27th Annual Western Protective Relay Conference, Spokane, 2000*.
- [7] V. Cook, "Distance protection performance during simultaneous faults," *Proceedings of the Institution of Electrical Engineers*, vol. 124, no. 2, pp. 141–146, 1977.
- [8] Z. Zhang, I. Voloh, and E. Pajuelo, "Distance relay performance during complex fault conditions," in *Western Protective Relaying Conference, 2012*.

Venkatesh C received the B.E. degree in Electrical and Electronics Engineering from the Madras University, India, in 2004, Post Graduation in thermal power plant engineering from National Power Training Institute, Neyveli, Ministry of Power, India, in 2005 and the M.Tech. degree from the Indian Institute of Technology Delhi, New Delhi, India in 2010 and holds PhD degree from Indian Institute of Technology Madras. He worked in Delhi Discom for five years where he handled protection, SCADA, commissioning. Since 2015 he has been with General Electric, and currently holds the position of Lead Engineer at GE Grid Solutions in Stafford, United Kingdom.

Ilia Voloh Ilia Voloh received the Electrical Engineering degree from Ivanovo State Power University, Ivanovo, Russia. He is currently an Applications Engineering Manager with GE Grid Solutions, Markham, ON, Canada. He has authored and coauthored more than 40 papers presented at major North America Protective Relaying conferences. His areas of interest are advanced power system protection algorithms and advanced communications for protective relaying. He is a member of IEC TC95 committee and an active member of the main IEEE PSRC committee.