

Open Phase Conditions in Transformers Analysis and Protection Algorithm

Amir Norouzi
 GE Digital Energy
 Markham, ON
 amir.norouzi@ge.com

Abstract—This paper first provides an in-depth analysis of open phase conditions in three phase power transformers. It describes why and how, upon loss of a single phase on the high or primary side of a transformer, voltages and currents on the low or secondary side greatly depend not only on the windings configuration but also sometimes on transformer's core construction as well. Some particular cases are discussed in which detecting a high side open phase is very difficult with current transformers (CT) only on the low side. Then after examination of the secondary voltages and currents practical and reliable patent pending algorithms are presented for identification and protection of high side open phase conditions from the low side of a power transformer. Digital simulation is used for verification of the analysis results and the protection algorithms.

I. INTRODUCTION

Open phase condition frequently occurs in power systems, particularly in medium voltage distribution networks (such as 33KV or below) in rural or remote areas where broken conductor, loose connection or a blown fuse can lead to an open phase. Some other cases of an open phase may involve a defective contact of a circuit breaker. This is considered a series fault with a different fault current calculation and sequence networks connection than other known shunt faults such as LG or LLG. In addition, an open phase on one side of a transformer can be very difficult to detect on the other side depending on the transformer's core and winding configuration as well as loading level.

In medium voltage distribution systems, industrial plants, and rural areas and for economic reasons often smaller transformers, such as 5MVA or below, are protected mostly on the load (low) side with the possibility of only fuses on the high side usually provided by the local utility. As will be shown, with an open phase on the high side of a transformer there are cases that the three phase voltages and currents on the low side could be fairly balanced, particularly in lower loading conditions, such that neither overcurrent nor negative sequence current elements can pick up a fault. In fact in lower loading conditions, even as high as 50% , the transformer may continue normal operation for hours and possibly longer with acceptable balanced voltages and currents on the low side while there is an open phase on the high side. Only in higher loading conditions may the protection relays pick up a fault, usually on negative sequence or sensitive ground overcurrent.

An open phase anomaly can also occur in distributed generation (DG). Many small DG sites, including landfill,

biogas, solar and wind power generation, are located in rural or remote areas with high chances of loss of a phase on the side of the local utility grid. With relay protection only on the low side of the grid interconnection transformer and with certain core or winding configurations an open phase on the grid side may go unnoticed for a while particularly in lower loading conditions.

It may initially seem that a high side open phase in a transformer will result in imbalances on the low side with enough significance that can be detected. Further analytical investigation will show the amount of imbalances of current and voltage on the low side depends on the winding configuration as well as sometimes core construction. For instance, while in a $Y-\Delta$ transformer (ungrounded Y) an open phase will create major unbalance voltages and currents that can be easily detected, in a $Y_g-\Delta$ transformer it may be very difficult to detect an open phase from the low side depending on the transformer loading.

An open phase on a transformer's primary side will create negative sequence current and voltage as well as ground overcurrent if it has Y_g winding on the same side. These are the main conditions that can be used to detect a fault when CTs are only on the secondary side of the transformer. However, relying on the low side negative sequence or ground overcurrent for open phase detection in transformers has two disadvantages. The first relates to the inherent inability of this method to detect an open phase condition in certain transformer core and winding configurations and lower loadings, leading to a gap in transformer protective relaying. This will be discussed in details in the next sections. The second disadvantage is that a negative sequence or ground overcurrent responding to an open phase condition on a transformer's high side could be unhelpful or even misleading in identifying the real cause of the problem, without which the system may not return to normal operating conditions. The low side protective relays will not allow the system to be re-energized because of the persistent high negative sequence or ground currents which leads to protracted down time with direct and indirect financial losses.

Therefore even in those transformer configurations that an open phase creates substantial and detectable imbalances on the low side finding the true cause of the protection relay operation can be confusing and tedious, particularly in remote locations with not an easy access to technical expertise. If the protection relay can accurately point to the specific cause of

the imbalance conditions, namely that there is an open phase on the high side, fixing the problem will be a much easier and faster task which will significantly reduce the down time.

II. THREE-PHASE TRANSFORMERS- A BRIEF REVIEW

In analyzing open phase conditions in three-phase transformers we will need a basic understanding of different ways transformers are built, particularly the core construction. While in steady-state study of a power system we may only need to know a transformer's parameters, ratings and winding configuration understanding a three-phase transformer's response to an open phase may also require further attention to its physical construction.

A. Construction of Three-Phase Transformers

Three-phase transformers are constructed in one of two ways: either by connecting three single phase transformers in a three-phase bank or by three sets of windings wrapped on a common core. A single core three-phase construction is widely preferred as it is more cost effective, lighter and smaller. However, in the older single phase bank approach each unit may be replaced individually in the event of a failure of that particular unit which is an advantage over common core construction.

Typically the common core construction is either core type or shell type as illustrated in Figures 1 to 4. Primary and secondary windings can be connected as either Y or Δ . Core type construction consists of legs (or limbs) and yokes. Both primary and secondary windings of each phase are on the same leg one on top of the other with the high voltage winding on the outer side. This winding construction has two advantages: it makes high voltage insulation easier and it results in less leakage flux. Yokes are the top and bottom part of the core that joins the legs together and have no windings.

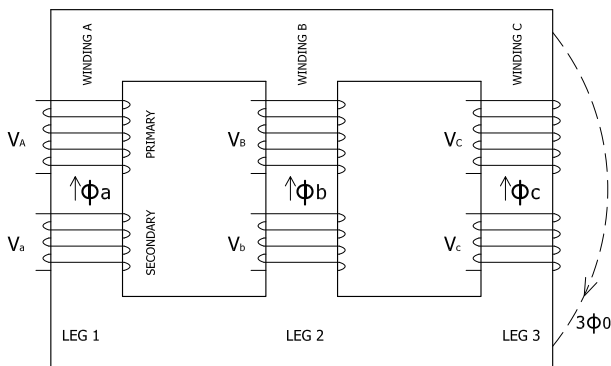

Fig. 1. Three-Leg Core Type Transformer

Core type construction may have 3, 4 or 5 legs with great impact on zero sequence flux, ϕ_0 , and zero sequence magnetizing current or magnetizing reactance, X_{0M} . In a balanced power system the three phase fluxes, ϕ_a , ϕ_b and ϕ_c , are also balanced with a vector sum of zero at the yoke. However, an unbalanced power system creates zero sequence flux as the sum of the three phase fluxes, $\phi_a + \phi_b + \phi_c$, is not

zero. As illustrated in Figure 1 in a three-leg core there is no return path for ϕ_0 and it has to pass through air gap or the tank with much higher magnetic reluctance than the core. This path of high reluctance for ϕ_0 in a three-leg core requires much higher amount of zero sequence magnetizing current which could lead to saturation and excessive heat. This equivalent to a much lower zero sequence magnetizing reactance in the parallel branch of the transformer model, typically about $1 pu$, which cannot be necessarily ignored when dealing with fault current calculations and zero sequence networks. For comparison, the magnetizing reactance of three-phase transformers for balanced conditions is typically $15 - 20 pu$ which can be easily ignored in the parallel branch of a transformer model.

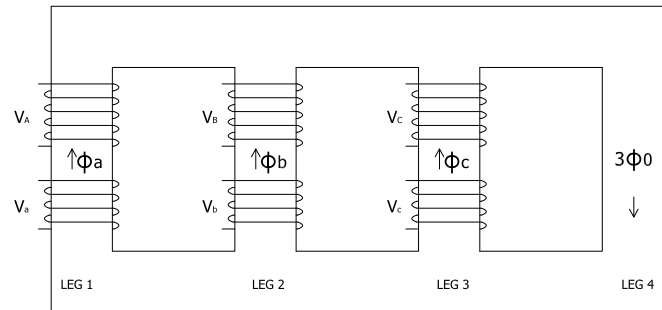

Fig. 2. Four-Leg Core Type Transformer

To provide a return path for ϕ_0 in unbalanced systems a fourth and even a fifth leg is added to the core type transformers as illustrated in Figures 2 and 3. Both four and five leg core type transformers have similar performance in dealing with zero sequence flux. Five-leg core helps reduce the size of the yoke as it will carry less ϕ_0 , thus smaller transformer size. Four and five leg transformers provide low reluctance path for ϕ_0 through the core with low zero sequence magnetizing current and large magnetizing reactance.

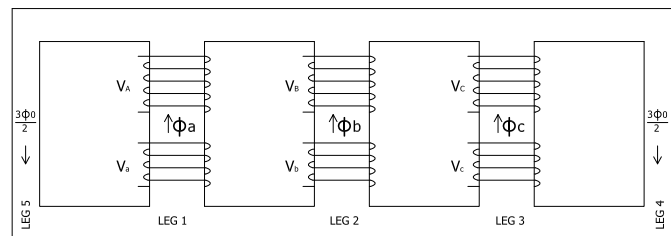

Fig. 3. Five-Leg Core Type Transformer

Shell type three-phase transformer design is illustrated in Figure 4 which is a variation of five-leg core type transformer. Three phase fluxes have multiple paths within the core. Shell type transformers provide return path for zero sequence flux and thus demonstrate a performance similar to four or five leg core type transformers when exposed to unbalanced system, i.e. low reluctance path for ϕ_0 and small zero sequence magnetizing current.

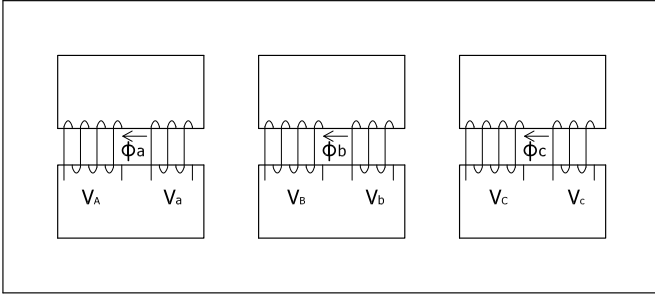

Fig. 4. Shell Type Transformer

B. Fundamental Equation of Magnetic Flux in Transformers

In discussing open phase conditions in transformers we also need to review the basic concept of the interaction between magnetic flux and induced voltage in transformers. This will also help understand transformer's response to an open phase.

Figure 5 shows a single phase transformer with $V_1 = V_m \cos \omega t$ applied to the primary winding with a total number of N_1 turns with no loads on the secondary winding. Recall from basic theory of transformer operation that a counter-voltage, e_1 , will be induced in winding 1 that is almost equal to V_1 provided that we assume magnetic reluctance of the core, \mathfrak{R} , and winding resistance, R , are negligible. This means that magnetization current and voltage drop in winding 1 are very small which is a reasonable assumption as long as the core is not saturated and operates within its linear magnetization curve.

The induced voltage, e_1 , will establish a magnetic flux, ϕ , in the core according to the Faraday's law, i.e. $e_1 = N_1 \frac{d\phi}{dt}$. With the assumption of $V_1 \approx e_1$ it follows that the flux will also be sinusoidal and can be obtained as:

$$\phi = \frac{1}{N_1} \int V_m \cos \omega t dt \quad (1)$$

$$\phi = \frac{V_m}{N_1 \omega} \sin \omega t = \frac{\sqrt{2} V_{rms}}{2\pi f N_1} \sin \omega t \quad (2)$$

Therefore magnetic flux, ϕ , is sinusoidal with an amplitude of $\phi_m = \frac{\sqrt{2} V_{rms}}{2\pi f N_1}$. We can write equation 2 in the following well-known format:

$$V_{rms} = 4.44 N_1 f \phi_m \quad (3)$$

Equation 3 is the fundamental equation that defines how voltage and magnetic flux interact in an unloaded transformer. The assumption is again that the core is not saturated and winding's voltage drop is negligible which are essential to this equation. The following important observations can be made from equation 3:

- As long as the core is not saturated and its magnetic reluctance is very small if a sinusoidal voltage is applied to one of the windings on the core it will establish a sinusoidal magnetic flux within the core. Considering that the winding's voltage drop is negligible the induced voltage e_1 is equal to the applied voltage V_1 .

- Magnitudes of induced voltage, e_1 , and flux ϕ are linearly proportional. With a known frequency and winding turns equation 3 may be reduced to $V_{rms} = K \phi_m$ which is a simple linear relationship.
- Magnitude of the established core flux is *solely* determined by the magnitude of the applied voltage, its frequency and winding turns. In other words, if voltage V_1 is applied to winding 1 magnetic flux ϕ is established in the core and similarly if flux ϕ passes through winding 1 voltage V_1 will be induced in that winding.

We will revisit these observations, particularly the last one, when discussing open phase conditions in transformers.

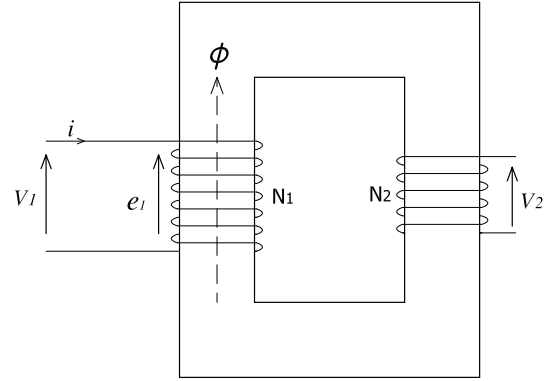
Fig. 5. Illustration of V_1 , e_1 and ϕ in an Unloaded Transformer

III. ANALYSIS OF OPEN PHASE CONDITIONS IN THREE-PHASE TRANSFORMERS

Before presenting this analysis of open phase conditions in three-phase transformers we need to review some basic assumptions as below:

- Open phase conditions or loss of a phase refers to one phase of the three phases being physically and unintentionally disconnected on the primary side of a transformer. This could occur for several reasons such as a loose cable, a broken conductor, a blown fuse, a circuit breaker with one defective contact, etc.
- *Primary* and *high side* terms are used interchangeably. This is the high voltage side of the transformer which is generally the grid side.
- *Secondary* and *low side* terms are used interchangeably. This is the low voltage side of the transformer which is generally the load or distributed generation (DG) side.
- Open phase is assumed to have occurred on the primary side of a transformer.
- There are no current transformers (CT) or protection voltage transformers (PT) on the high voltage terminals of the transformers being discussed.

First in III-A the impact of an open phase on the primary winding are discussed *independently and without* considering any magnetic or electric interaction between high and low side of the transformer. Then in III-B with the help of the first part open phase conditions will be examined with complete consideration of the interaction between the primary and secondary sides.

A. Primary Side Investigation (Independent From the Low Side)

Grounded (Y_g) and ungrounded (Δ or Y) primary windings will respond differently to an open phase.

1) *Grounded Primary (Y_g):* In Figure 6 with phase A open I_A is zero. It is assumed that the utility grid supplying the high side is strong enough that upon loss of phase A voltages of the other phases, V_B and V_C will essentially remain the same.

Now if the transformer is three-leg core type, as illustrated in Figure 1, the only return path for ϕ_A and ϕ_B is through the coil of the disconnected phase A . Therefore, $\phi_A = -\phi_B - \phi_C$ which is still the same as when phase A was connected to the transformer (in balanced conditions before the phase loss $\phi_A + \phi_B + \phi_C = 0$). This is because from observations of Section II-B we know magnetic flux of a winding is solely determined by voltage, frequency and winding turns and here with all three parameters essentially the same before and after the open phase conditions ϕ_B and ϕ_C will also remain the same. Hence the same ϕ_A is passing through winding A which means the same voltage, V_A , will be induced in this winding. Therefore, in a three-leg transformer with Y_g primary windings the winding with the lost phase will have an induced voltage equal to the voltage before the open phase occurrence.

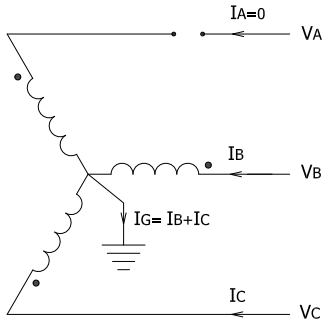

Fig. 6. Y_g Primary Winding with Phase A Open

However, in other types of transformer cores upon open phase conditions either a fraction of ϕ_B and ϕ_C will pass through winding A (4-leg, 5-leg, shell type) or there is no flux linkage between the phases at all (three single phase bank). In either case there is very little or no voltage induced in the winding with lost phase.

As illustrated in Figure 6 and regardless of the core type, upon loss of phase A the ground current at the neutral point of the transformer is per below equation. We will use this equation later in the discussions on the open phase condition in transformers.

$$I_G = 3I_0 = I_B + I_C \quad (4)$$

2) *Ungrounded Primary (Δ or Y):* Figure 7 illustrates a primary Δ winding with phase A open. With an ABC phase sequence this is $D11$ configuration, i.e. Δ side lags the secondary Y side by 30° . The individual phase coils are called ω_A, ω_B and ω_C . With phase A open the voltage across ω_B is

still V_{BC} and remains unchanged. However, V_{BC} is evenly divided between coils ω_A and ω_C . After the loss of phase A and considering the dot convention the followings are true for the coil voltages and line currents:

$$V_{\omega_B} = V_{BC} \quad (5)$$

$$V_{\omega_A} = V_{\omega_C} = -\frac{1}{2}V_{BC} = \frac{1}{2}V_{BC} \angle 180^\circ \quad (6)$$

$$I_A = 0; I_C = -I_B \quad (7)$$

For a $D11$ configuration, equation 6 will become $V_{\omega_A} = V_{\omega_B} = \frac{1}{2}V_{BC}$ with $V_{\omega_C} = V_{BC}$.

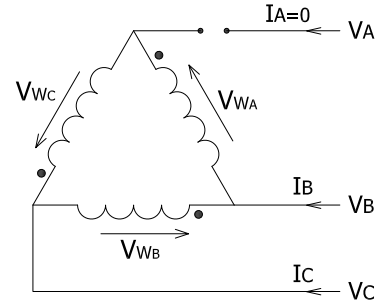

Fig. 7. Δ Primary Winding with Phase A Open

For an ungrounded Y primary in Figure 8 and with the same assumption that V_B and V_C are the same before and after phase A is open we will have the followings for voltages across each coil and line currents:

$$V_{\omega_A} = 0 \quad (8)$$

$$V_{\omega_B} = -V_{\omega_C} = \frac{1}{2}V_{BC} \quad (9)$$

$$I_A = 0; I_C = -I_B \quad (10)$$

Hence the following observations can be made for an ungrounded primary winding, Δ or Y , when one phase is open:

- In Δ primary the coil with no lost phases will have the same voltage as before the open phase conditions. The other two coils will maintain half of their original voltages. These voltages will have the same *magnitude and phase angle* although the new angle is totally different from before the loss of phase. This is *regardless* of the physical construction of the transformer, whether three/four/five legs or three single phase bank. Besides, the remaining two coils will have currents with equal magnitude but 180° apart. With these voltages and currents the system will be substantially unbalanced.
- In Y primary voltage of the coil with lost phase is always zero regardless of the physical construction of the transformer. This is because the other two coils will always have *equal but opposite* voltages which means

the magnetic fluxes of the two remaining coils are also equal and opposite, i.e. $\phi_B = -\phi_C$. Therefore, in core and shell type transformers no flux can go through any paths, including leg A or ω_A , except the path of legs B and C and part of the yokes that joints these two legs. This can be observed by examination of Figures 2 to 4. Similar to Δ winding case, currents of the two remaining phases of the Y winding will be equal in magnitude but with opposite direction, i.e. $I_C = -I_B$.

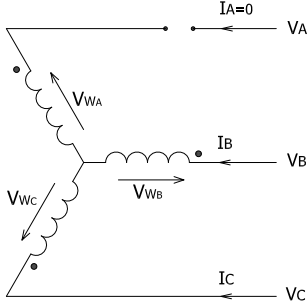

Fig. 8. Y Primary Winding with Phase A Open

B. Open Phase Conditions in Transformers

With the discussion and findings of Section III-A we can now investigate open phase conditions in transformers in greater details with consideration of magnetic and electrical interactions within the three-phase transformer. Here transformers with commonly used configuration, including Y_g - Δ , Δ - Y_g , Y_g - Y_g , Δ - Δ are examined. Ungrounded Y will also be discussed. The first letter indicates the high side of the transformer.

1) Y_g - Δ Transformers: Y_g - Δ transformer is one of the most commonly used configurations. With Y_g on the high side each coil is subjected to $\frac{1}{\sqrt{3}}$ or 57.7% of line voltage which makes it easier to insulate the primary coils. In distributed generation (DG) applications with the DG source on the Δ side the grid cannot contribute to a ground fault on the DG generator while in case of a ground fault on the grid DG can contribute to the fault which makes the anti-islanding protection more practical by sensing the ground current on the neutral of the Y_g . This is a useful characteristic of this configuration which makes it preferable in DG.

Figure 9 illustrates a Y_g - Δ transformer with phase A open on the high side. Assuming that the high side is strong enough that V_B and V_C are almost the same after loss of phase A (except for additional voltage drop due to larger I_B and I_C as will be discussed later) low side coils of ω_b and ω_c will have the same induced voltage as before loss of phase A . This is because high side coils of ω_B and ω_C still have the same voltage, hence the same induced voltage on the corresponding low side coils. Therefore, upon loss of phase A , voltage in coil a will be:

$$V_{\omega_a} = -V_{\omega_b} - V_{\omega_c} \quad (11)$$

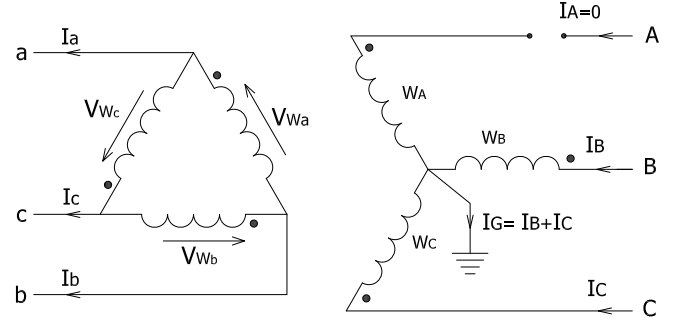

Fig. 9. Open Phase in a Y_g - Δ Transformer

Which is the same as when coil a was energized from the high side coil A (before loss of phase A we had $V_{\omega_a} + V_{\omega_b} + V_{\omega_c} = 0$).

It is important to notice that, despite discussions on Y_g primary in Section III-A1 and how similar voltage may or may not be induced on the coil with lost phase depending on the construction of the transformer, here V_{ω_a} and V_{ω_A} are *always* re-generated *regardless* of transformer's construction, including three single-phase banks. This is because the interaction between the primary and secondary coils is taken into consideration. In fact re-generation of voltages of the coils with lost phase is by a different mechanism than what was discussed in Section III-A1.

In an unloaded Y_g - Δ transformer both the high and low side voltages corresponding to the lost phase is perfectly re-generated such that effectively no change in three phase voltage magnitudes and angles is seen on primary and secondary sides. When loads are added the transformer will continue to supply the low side loads from all three phases as before the phase loss with the following important notes:

- 1) With almost the same line voltages on the low side the transformer will supply nearly the same power to the loads.
- 2) On the high side power is carried only by the remaining two phases. Therefore, the current on those phases will be roughly 50% larger than before the loss of phase. However, since the high side is no longer a three-phase system new phase angles will be established. The new I_B and I_C will be apart considerably different from the 120° of a three-phase balanced system.
- 3) The high side coil with lost voltage and its corresponding coil on the low side *do not* carry any power, despite both coils being energized with almost the same voltage. Coil a on the low side *doesn't* carry any current except a very small current for magnetization and losses. This is simply because high side coil A doesn't transfer any power to coil a and this is the only way coil a can receive power from the primary side. It follows that power being supplied to the load by phases a , b and c all come from only two coils on the low and high sides, particularly power being supplied by phase a is actually being provided only by coils b and c . We will

see that this is fundamentally different from three-leg core Y_g - Y_g transformers where the low side coil with lost phase carries current and real power because the re-generated voltage comes from flux interaction, not a simple voltage build-up. Hence despite the line currents I_a , I_b and I_c being almost unchanged the current of coils b and c are roughly 50% larger than before to supply the additional power to be transferred by line a .

- 4) As the loads are being added on the low side the perfect balanced voltages of the unloaded transformer will start to become more unbalanced with line voltages and currents being more and more unbalanced. The main elements impacting the system balance conditions are *leakage flux* and *voltage drop*. With higher currents after the phase loss come larger leakage flux and voltage drop. As the high side line currents and also low side coil currents will become considerably larger roughly by a factor of 50% two types of voltage drops will appear: one is voltage drop on the feeders supplying the transformer's primary side which makes the high side terminal voltages lower than before. The other voltage drop is due to high and low side active coils carrying again about 50% more current than before. The coil voltage drops impact the low side terminal voltages of the active coils, but the coil corresponding to the lost phase doesn't carry current and not being impacted by the internal transformer voltage drops.

To better demonstrate the above characteristics in Y_g - Δ transformers, a digital simulation using MATLAB's Simulink was performed. The transformer has a five-leg core, but we saw that in Y_g - Δ this has no impact on transformer's response to an open phase conditions. Consider the power system of Figure 10. Two different loading conditions are considered: a light resistive load of 60KW and a larger load of 600KW (33%).

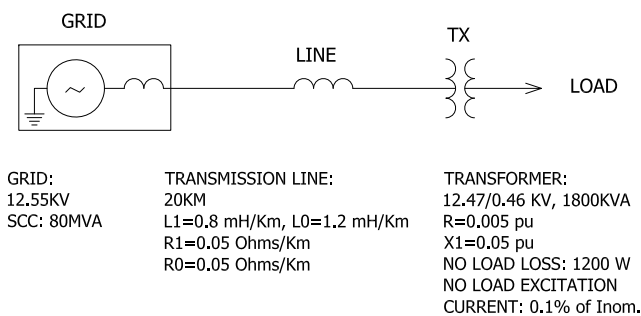

Fig. 10. Single Line Diagram of the Sample Power System

Figure 11 illustrates simulation results for an open phase condition which occurs at $t = 0.1\text{Sec}$. on phase A when the transformer is lightly loaded at 60KW. Only low and high side voltages and currents are shown. Low side voltages and currents as well as high side voltages are very balanced after the loss of phase and almost the same power is being supplied to the load. While $I_A = 0$ after phase A is lost the other two currents, I_B and I_C considerably increase to compensate for the lost phase in order to supply the same power to the load.

Further simulation results show that on the low side $\frac{I_2}{I_1}$ and $\frac{V_2}{V_1}$ are about 0.62% which demonstrate a quite balanced system.

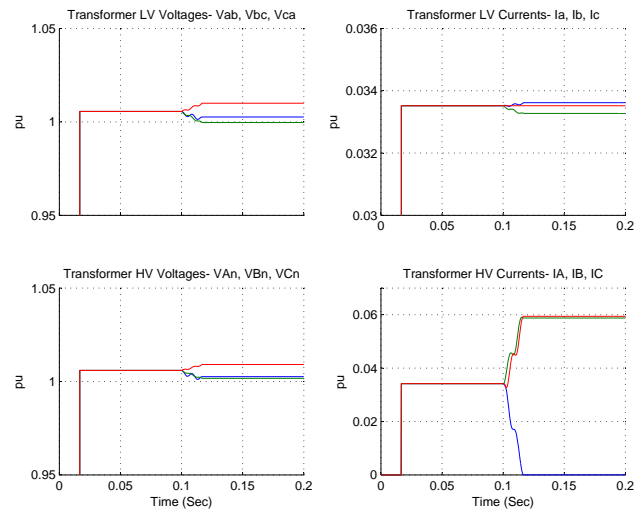

Fig. 11. Simulation Results for a Y_g - Δ Transformer After Loss of Phase A- Load=60KW

Figure 12 illustrates simulation results for the same system and conditions but the transformer is loaded at 600KW or 33% of its rated power. Here we can see the impact of greater currents and the associated higher voltage drops and leakage flux on the system voltages. Although the transformer still supplies close to 33% of its rated power to the load after the loss of one phase the high side currents of the two remaining phases are more than 50% of the rated current. The simulation results show that on the low side $\frac{I_2}{I_1}$ and $\frac{V_2}{V_1}$ are about 5.9%, much greater than the previous lightly loaded conditions, but still not a highly unbalanced system. After loss of phase the transformer still delivers 96.4% of the power it was delivering before the fault.

Figure 13 illustrates individual coil currents on the low (Δ) side. As discussed earlier although coil a is energized it doesn't carry any current (except for the magnetizing current and losses) and power after loss of phase. All three phases on the low side receive power from only the two remaining coils.

The protection elements that may seem to be applicable to open phase conditions on the transformer's low side are mainly negative sequence voltage or current as well as ground overcurrent. From the above discussions and example we see that in a Y_g - Δ transformer negative sequence quantities are quite low and may not necessarily be relied on for open phase conditions. The other protection element, ground overcurrent, is meant to be used for ground faults on the grid side of the transformer and hence is usually set somewhat below the ground fault level which is most of the time considerably higher than the transformer's rated phase current. From equation 4 we know that the ground current of the Y_g is $I_G = I_B + I_C$ upon loss of phase A . However, this is not a conventional three-phase system with current vectors 120° apart. Assuming that upon loss of a phase the high side currents will rise about 50%, ground current, I_G , is roughly $\sqrt{3}$ times the phase current, and that the ground overcurrent

is set 50% higher than the transformer's full load current we can estimate that if transformer's pre-fault current is up to about 60% of its rated current ground overcurrent element will not pick any fault. This is why this protection element is not reliable either in dealing with open phase conditions. Even if ground overcurrent detects a fault there is little indication that the fault is actually due to an open phase and not a ground fault.

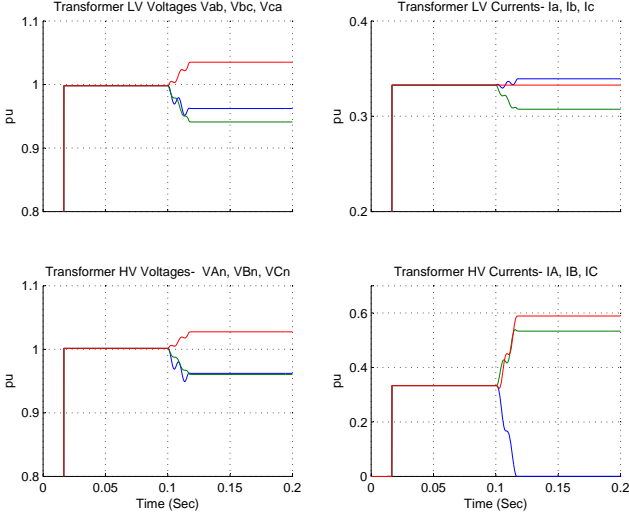

Fig. 12. Simulation Results for a Y_g - Δ Transformer After Loss of Phase A- Load=600KW

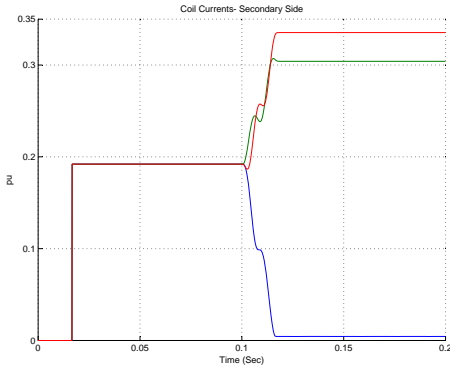

Fig. 13. Coil Currents on the Secondary Side After Loss of Phase A- Load=600KW

A note on open phase fault calculations: Open phase is considered a series fault in power systems. Similar to the shunt faults such as LG or LLG sequence network connections for series faults have also been developed to calculate system currents and voltages upon such faults, although series fault calculations are less well-known than shunt faults. For instance see [3], [6] and [7] for discussions and examples of such fault calculations. Although fault currents and voltages can be calculated by open phase sequence network modeling it won't provide the insight and systematic examination as how and why certain voltage and currents are seen upon loss of a phase in a transformer. To develop a protection algorithm we need to be able to establish

specific conclusions applicable to open phase conditions in any type of transformer construction and configuration and series fault calculations don't provide such analytical tool. Besides, fault calculation methods are not necessarily capable of handling those cases that closely depend on the physical construction of the transformer such as Y_g - Y_g .

2) Transformers with Ungrounded Primary (Δ or Y):

Transformers with Δ or ungrounded Y primary demonstrate similar characteristics upon loss of a phase regardless of the secondary configuration or core construction. These characteristics are obtained and discussed in this section. We will see that same protection principle can be applied to such transformers as Δ - Y_g , Δ - Y , Δ - Δ , Y - Δ , Y - Y_g and Y - Y .

What is common among all such transformers with ungrounded primary winding is that upon loss of a single phase there will be substantial voltage unbalance on both primary and secondary side of the transformer. As discussed in III-A2 only half of the phase-phase voltage will appear on two of the primary coils. Therefore, with considerable voltage and current drops protection elements such as undervoltage or negative sequence current will pick up a fault on the primary side.

An example is illustrated in Figure 14 where a Δ - Y_g transformer has an open phase A on the high side. With an ungrounded Δ primary winding, as discussed in III-A2, only half of the line voltage will be established across the two coils associated with the lost phase on the high side, i.e. coils ω_A and ω_C . See equations 6. Therefore, in the corresponding secondary coils of ω_a and ω_c a voltage equal to half the pre-fault voltage will be induced. While here, unlike Y_g - Δ transformers, there is no voltage re-generation and existing protection elements will detect a fault finding the actual cause of the fault can be a challenge as none of these elements firmly suggest an open phase condition on the high side.

To further investigate such cases of open phase we can use the following well-known equations to obtain sequence currents, I_1 and I_2 , on the high side of the transformer in Figure 14 ($I_0 = 0$), where $a = 1\angle 120^\circ$:

$$I_1 = \frac{1}{3}(I_A + aI_B + a^2I_C) \quad (12)$$

$$I_2 = \frac{1}{3}(I_A + a^2I_B + aI_C)$$

We observed that $I_A = 0$ and $I_C = -I_B$. Substituting in the above equations we will have:

$$I_A = 0 \Rightarrow \frac{I_2}{I_1} = 1\angle 180^\circ \quad (13)$$

Similarly for open phase on other phases we have:

$$I_B = 0 \Rightarrow \frac{I_2}{I_1} = 1\angle -60^\circ \quad (14)$$

$$I_C = 0 \Rightarrow \frac{I_2}{I_1} = 1\angle 60^\circ \quad (15)$$

The above equations are always true for a Δ or ungrounded Y primary transformer *regardless* of the core construction and secondary configuration, whether it is Y_g , Y , or Δ . We now

need to obtain the corresponding I_1 and I_2 relationships on the secondary side where the CTs are located. This is only a matter of phase angle shift of the sequence currents.

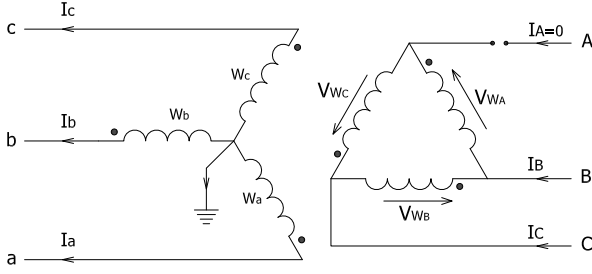

Fig. 14. Δ - Y_g Transformer with Phase A Open on the High Side

When converting sequence voltages and currents from one side of a transformer to the other side the positive sequence values get a phase angle shift in the same direction of the transformer's vector group while negative sequence values get a phase angle shift in the opposite direction. For example, if the primary side of a transformer lags the secondary side by 30° then $I_{1Pri.}$ will also lag $I_{1Sec.}$ by 30° while $I_{2Pri.}$ lags $I_{2Sec.}$ by -30° or leads it by 30° . Hence, for this transformer $\frac{I_{2Sec.}}{I_{1Sec.}} = \frac{I_{2Pri.}}{I_{1Pri.}} \angle -60^\circ$ as $I_{1Pri.}$ and $I_{2Pri.}$ will transfer to the secondary side with the same ratio but opposite phase angle shifts.

We can now establish the following values for $\frac{I_{2Sec.}}{I_{1Sec.}}$, as in Table A, that apply to negative and positive sequence currents on the low side of a transformer with an ungrounded primary winding of Δ or Y upon loss of a single phase on the high side. This is regardless of the core construction and secondary winding configuration. It also applies to DG cases where there is a generation source on the low side exporting power to the grid. All we need to know is the phase angle shift of low side in relation to the high side. In each case high side equations 13, 14 and 15 are re-written for the low side with appropriate phase angle shift.

Table A: $\frac{I_2}{I_1}$ Values on the Transformer's Low side with an Open Phase on the Ungrounded High side

Case	Pri. and Sec. in phase	Pri. lags Sec. by 30°	Pri. leads Sec. by 30°
A Open	$1 \angle 180^\circ$	$1 \angle 120^\circ$	$1 \angle -120^\circ$
B Open	$1 \angle -60^\circ$	$1 \angle -120^\circ$	$1 \angle 0^\circ$
C Open	$1 \angle 60^\circ$	$1 \angle 0^\circ$	$1 \angle 120^\circ$

Table A shows the common phase angle shifts in transformers. Examples of a transformer with primary and secondary in phase are Δ - Δ (D1-D1) or Y - Y . For other special phase angle shifts the corresponding $\frac{I_2}{I_1}$ can be further determined with similar exercise. Since phase sequence of the power system (ABC or ACB) also impacts the vector rotation of a transformer phase angle shift must be carefully determined before using the above equations. In any case, with a Δ or ungrounded Y primary and upon loss of a single phase positive and negative sequence currents will have equal magnitudes, i.e. $|I_2| = |I_1|$ both on primary and secondary sides. By

using Table A it can be quickly established if there is an open phase on the high side and further determine which phase is actually lost. Values of Table A can be applied in any loading conditions, including when the transformer is loaded at a very small percentage of its rated power.

To demonstrate an open phase condition in a transformer with ungrounded primary a digital simulation is carried out on the sample single line diagram of the Figure 10 where the transformer is Δ - Y_g with a pre-fault load of 100KW. Phase B is lost at $t = 0.1Sec.$ Primary and secondary voltages as well $\frac{I_2}{I_1}$ as measured on the low side are illustrated in Figure 15. As expected two voltages on the primary and hence two corresponding voltages on the secondary drop to half of their pre-fault values. This will result in similar drop in the currents which is a significant unbalance condition. Low side positive and negative sequence currents have equal magnitudes with a phase displacement of -120° in accordance with Table A.

Replacing Δ - Y_g transformer of the above example with other types of ungrounded primary configurations, namely Δ - Y , Δ - Δ , Y - Δ , Y - Y_g and Y - Y , will produce the same results as far as the transformer voltages and $\frac{I_2}{I_1}$ values. Hence, same principle is applicable to all these transformers regardless of physical construction of the transformer.

3) Y_g - Y_g Transformers: So far we've seen that, regardless of the core construction, in Y_g - Δ transformers the lost phase is always re-generated while in transformers with Δ or Y primary the lost phase is never re-generated. In Y_g - Y_g transformers the core construction has a major impact on the transformer's response to an open phase. Depending on the core type a Y_g - Y_g transformer may or may not re-generate the lost phase, making it a special case when dealing with open phase conditions in transformers, although it is less commonly used than Y_g - Δ transformers. Figure 16 illustrates a Y_g - Y_g transformer with phase A open on the high side.

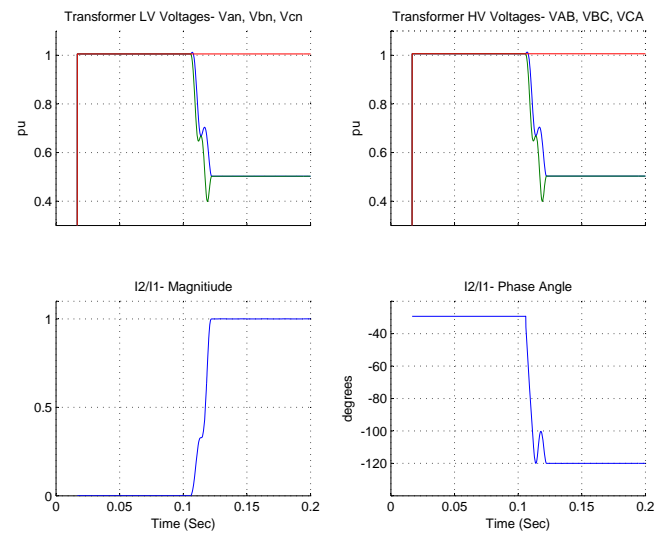

Fig. 15. Simulation Results for a Δ - Y_g Transformer After Loss of Phase B- Load=100KW

In Section III-A1 we saw how the lost voltage is re-

generated internally in a Y_g winding when the transformer has a three-leg core because the magnetic flux of the two remaining phases will have no other path within the core than the third leg with the lost phase. In Y_g - Δ transformers the source of voltage re-generation is voltage build-up across the low side coil with lost phase due to simple electrical interaction between the three low side coils, which in turn induces a voltage on the corresponding primary coil as discussed in III-B1. No flux interaction and therefore no energy transfer between primary and secondary sides is engaged in this process of voltage re-generation, hence no power from the low side coil with lost phase as we saw in III-B1. However, in three-leg Y_g - Y_g transformers it is the flux build-up in the third leg that first induces a voltage across the primary coil with lost phase which then induces a voltage on the corresponding low side coil. In this process flux interaction is the source of voltage re-generation and therefore energy (power) is transferred from the high side coil with lost phase to its corresponding low side coil and hence all three coils of the secondary side *will carry power* as before open phase condition occurred. This is an unusual case where one of the transformer's primary coils receives power not electrically from its feeder but rather magnetically from the core.

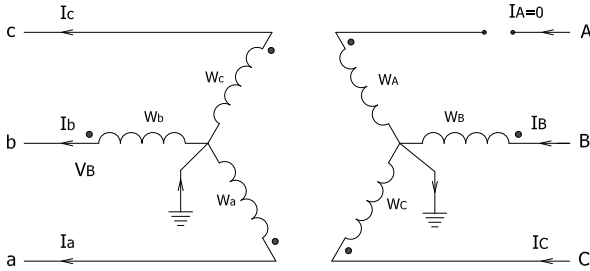

Fig. 16. Y_g - Y_g Transformer With an Open Phase

This voltage re-generation in Y_g - Y_g is of course specific to three-leg core type transformers. When the core has four or five legs or when the transformer bank consists of three single phase transformers no voltage re-generation takes place as we saw earlier. The same principle applies to Y_g - Y transformers in regard to three-leg or other types of construction, although practically Y_g - Y is not a commonly used configuration.

There is another aspect to the process of voltage re-generation in Y_g - Y_g transformers that makes it yet more different from Y_g - Δ transformers. We saw that in Y_g - Δ transformers as the load increases transformer voltages drop and also become more unbalanced due to the increased leakage flux as well as additional voltage drops inside and outside of the transformer. In Y_g - Y_g transformers increased leakage flux has more considerable impact on the re-generated voltage as the induced voltage comes directly from the flux. So far we have assumed that the magnetic fluxes of the two remaining coils entirely pass through the coil with the lost phase to induce the same voltage as before the loss of phase. See Figure 1 for a reminder. While this might be true for no or very small load conditions the fact is that not all the fluxes can pass through the third leg because in real world the core is not ideal and

some portion of the fluxes will go through a path outside of the core such as air or tank. This portion of the flux is called leakage flux. The higher the transformer load, i.e. the higher the flux within each coil, the higher the leakage flux which means less of the coil fluxes, ϕ_B and ϕ_C , will pass through the third leg with lost phase as a bigger portion of them circulate outside of the core. This will result in less induced voltage in the coil of the third leg. Therefore, with larger loads we expect to see larger voltage drop on the lost phase than a similar Y_g - Δ transformer would have produced.

In summary the important aspects of voltage re-generation in a Y_g - Y_g transformer upon loss of a phase on the high side are:

- 1) Only in three-leg core type Y_g - Y_g transformers the voltage of the lost phase is re-generated. In transformers with four or five leg cores or a bank of three single phase transformers there is no voltage re-generation.
- 2) The voltage of the lost phase is re-generated by the flux that goes through the coil on the third leg in accordance with equation 3. Energy is transferred to the high side coil with the lost phase by magnetic fluxes of the two remaining phases which is then transferred to the low side coil. This is different from Y_g - Δ transformers where the voltage is re-generated on the low side due to electrical interaction between the coils and then induced back to the primary coil with both coils associated with the lost phase not carrying any current or power.
- 3) As the transformer load increases there will be larger voltage drop on the coils with lost phase due to leakage fluxes of the primary coils. This means that not all the fluxes can go through the third leg which then results in less induced voltage in the coil with lost phase.

To demonstrate characteristics of three-leg Y_g - Y_g transformers in loss of phase conditions digital simulation was performed on the sample power system of Figure 10. Two different loads are considered. Figure 17 illustrates the results for 60KW load and Figure 18 is for a transformer load of 600KW. Phase A is lost at $t = 0.1\text{Sec}$.

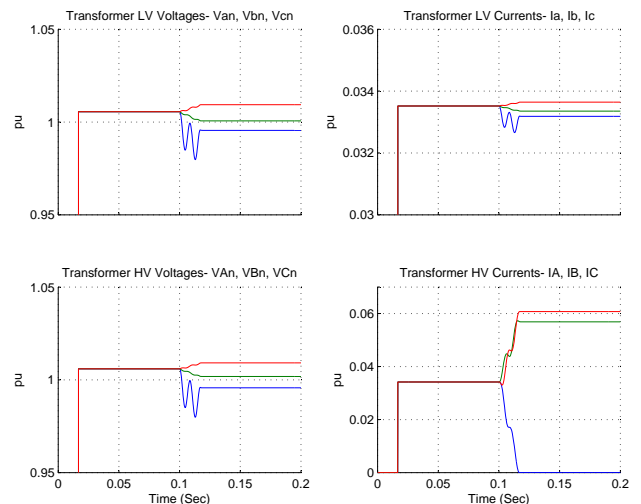

Fig. 17. Simulation Results for a Three-leg Y_g - Y_g Transformer After Loss of Phase A- Load=60KW

Comparing simulation results for Y_g - Y_g transformer with that of the Y_g - Δ in Section III-B1 we can see that for similar loads Y_g - Y_g transformer demonstrates considerably more unbalance conditions after loss of a phase. While for the Y_g - Δ transformer $\frac{I_2}{I_1}$ and $\frac{V_2}{V_1}$ were 0.62% for a 60KW load and 5.9% for a 600KW load, here simulation results show that $\frac{I_2}{I_1}$ and $\frac{V_2}{V_1}$ are 3.8% for the 60KW load and 30.4% for the 600KW load which are significantly higher than the corresponding values in the case of the Y_g - Δ transformer.

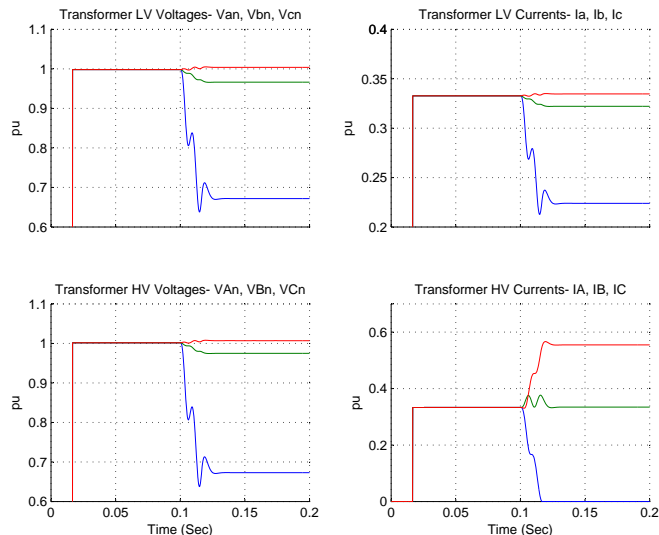

Fig. 18. Simulation Results for a Three-leg Y_g - Y_g Transformer After Loss of Phase A- Load=600KW

Figure 19 illustrates simulation results for the same system but with a five-leg Y_g - Y_g transformer. Since there is no voltage re-generation for the coil with lost phase, voltage on the corresponding primary and secondary coils completely collapse. Unlike three-core Y_g - Y_g or Y_g - Δ transformers that continue to supply power to all three phases on the secondary here five-core Y_g - Y_g transformer delivers $\frac{2}{3}$ of the original power on two of the phases. There is no increase in transformer currents while low and high side currents and voltages of the remaining phases are essentially unchanged. Low side system is completely unbalanced with basic voltage or current protection elements detecting a fault.

IV. PROTECTION ALGORITHMS FOR OPEN PHASE CONDITIONS IN TRANSFORMERS

We saw that generally a transformer's response to an open phase on the high side can be categorized as one of the three cases we discussed: 1) Y_g - Δ transformers in which lost phase is always re-generated, 2) transformers with Δ or ungrounded Y primaries in which the lost voltage is never re-generated, and 3) Y_g - Y_g transformers that the response depends on the core construction. The examination of these cases has provided some key characteristics and aspects of each category that can be used to develop new protection algorithms specific to open phase conditions in transformers. The assumption is that there are no phase CTs or PTs on the high side of the transformer. We now examine each category for a protection algorithm.

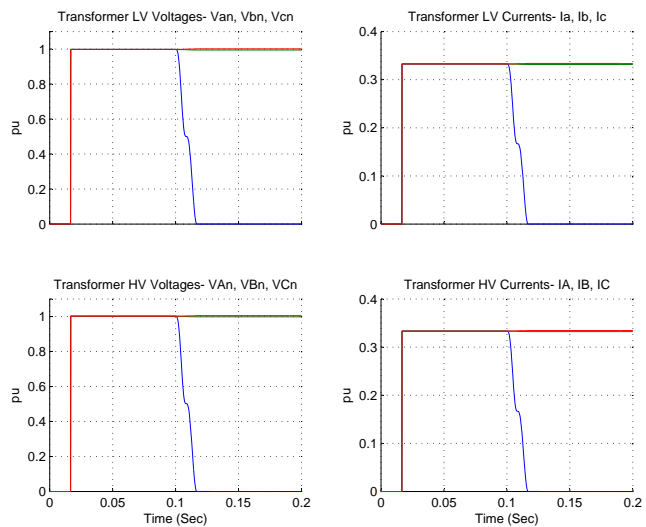

Fig. 19. Simulation Results for a Five-leg Y_g - Y_g Transformer After Loss of Phase A- Load=600KW

A. Y_g - Δ Transformers

As discussed in Section III-B1 low side voltages or currents may not be always helpful in detecting a fault upon loss of a phase particularly in lower loading levels. After open phase condition the high side currents are highly unbalanced with one phase having no current and therefore negative and zero sequence components are involved in the high side currents. If we are to construct the high side currents from the low side CTs we need to have these primary components available. Of particular importance is the primary side zero sequence current, I_{0Y} , which is not actually available on the low side as all zero sequence components are circulating inside the Δ winding. However, using the neutral CT of the Y_g side of the transformer can solve the issue of I_{0Y} . In most installations this neutral CT is available to detect ground faults on the high side. The neutral CT has voltage insulation level much lower than the phase CTs and hence should be a low cost CT.

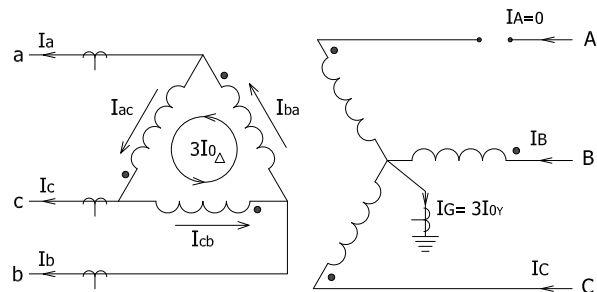

Fig. 20. Y_g - Δ Transformer with D1 Secondary Winding

Figure 20 illustrates a Y_g - Δ transformer with Δ winding configured as D1 where it lags the Y side by 30° if system sequence is ABC. If transformer's ratio is defined as $n = \frac{V_{ABnom.}}{V_{abnom.}}$ we will have the following relationship between I_{0Y} , circulating zero sequence current inside Δ winding, $I_{0\Delta}$, and the measurement of the high side neutral current

transformer, I_G . This makes $I_{0\Delta}$ available to the protection system.

$$I_{0\Delta} = \frac{n}{\sqrt{3}} I_{0Y} = \frac{1}{3\sqrt{3}} n I_G \quad (16)$$

In Figure 20 we have the following set of equations for the low side currents of the transformer:

$$\begin{aligned} I_a &= I_{ba} - I_{ac} \\ I_b &= I_{cb} - I_{ba} \\ I_c &= I_{ac} - I_{cb} \\ I_{ba} + I_{ac} + I_{cb} &= 3I_{0\Delta} \\ I_a + I_b + I_c &= 0 \end{aligned} \quad (17)$$

In the above set of equations I_a , I_b and I_c are available from the low side phase CTs and $I_{0\Delta}$ is available from equation 16 which comes from the neutral CT of the Y_g side. We can now solve the set of equations in (17) to obtain I_{ba} , I_{cb} and I_{ac} . By doing so the coil currents of the Δ winding are:

$$\begin{aligned} I_{ba} &= \frac{1}{3}(I_a - I_b) + I_{0\Delta} \\ I_{cb} &= \frac{1}{3}(I_b - I_c) + I_{0\Delta} \\ I_{ac} &= \frac{1}{3}(I_c - I_a) + I_{0\Delta} \end{aligned} \quad (18)$$

Then high side currents of the transformer are obtained by simply applying the transformer ratio, $n = \left| \frac{V_{ABnom}}{V_{abnom}} \right|$, to the Δ currents which leads us to the following set of equations:

$$\begin{aligned} I_A &= \frac{\sqrt{3}}{n} I_{ba} \\ I_B &= \frac{\sqrt{3}}{n} I_{cb} \\ I_C &= \frac{\sqrt{3}}{n} I_{ac} \end{aligned} \quad (19)$$

Equations 18 and 19 provide primary side currents in a Y_g - Δ transformer in any conditions and loading level as long as there is no internal fault to the transformer. While external faults don't violate these equations an internal fault in the transformer can make the equations invalid. In our application of open phase condition by using these equations we can identify an open phase by observing that one of the phase currents of the high side is zero. Considering the CTs inaccuracy we may declare an open phase when one of the currents obtained from equation 19 is much below the other two phases while currents on the low side of the transformer appear to be highly balanced.

One other way of connecting three coils in a Δ winding is illustrated in Figure 21. In this configuration Δ side leads the Y side by 30° if system sequence is ABC and is called D11. The following set of equations applies to the Δ side currents, where $I_{0\Delta}$ is from the neutral CT as per equation 16.

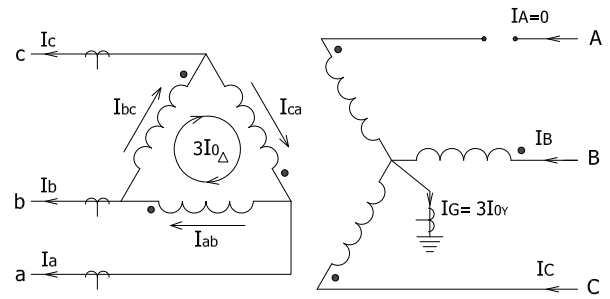

Fig. 21. Y_g - Δ Transformer with D11 Secondary Winding

$$\begin{aligned} I_a &= I_{ca} - I_{ab} \\ I_b &= I_{ab} - I_{bc} \\ I_c &= I_{bc} - I_{ca} \\ I_{ab} + I_{ca} + I_{bc} &= 3I_{0\Delta} \\ I_a + I_b + I_c &= 0 \end{aligned} \quad (20)$$

Solving (20) for I_{ab} , I_{bc} and I_{ca} we obtain:

$$\begin{aligned} I_{ab} &= \frac{1}{3}(I_b - I_a) + I_{0\Delta} \\ I_{bc} &= \frac{1}{3}(I_c - I_b) + I_{0\Delta} \\ I_{ca} &= \frac{1}{3}(I_a - I_c) + I_{0\Delta} \end{aligned} \quad (21)$$

The high side currents are then:

$$\begin{aligned} I_A &= \frac{\sqrt{3}}{n} I_{ca} \\ I_B &= \frac{\sqrt{3}}{n} I_{ab} \\ I_C &= \frac{\sqrt{3}}{n} I_{bc} \end{aligned} \quad (22)$$

Equations 21 and 22 provide high side currents of a Y_g - Δ transformer with winding configuration of Figure 21. Again, these equations are true for any transformer conditions, except for transformer's internal faults, that can be used to identify an open phase on the primary side of the transformer when one of the phase currents are calculated as being zero or close to zero in comparison to the other two phases.

The equations and algorithm presented here are applicable to any transformer physical construction or any transformer loading conditions and also in DG cases where there is a generating source on the low side exporting power to the grid. In DG applications the flow of power will be opposite to when there is only load on the low side and the direction of all primary and secondary currents in Figures 20 and 21 will reverse. However, by maintaining the same CT connections as in the non-DG cases discussed here all equations presented in this Section are directly applicable to DG as well.

Figure 22 illustrates simulation results for the same system of Section III-B1 with 60KW load on the transformer. Recall from Figure 11 that due to the very small load on the

transformer the low side voltages and currents were highly balanced after open phase condition. Figure 22 shows primary side currents, I_A , I_B and I_C , both as measured from the high side and calculated from the low side using equations 18 and 19. Based on the high side calculated currents the protection algorithm can identify an open phase on phase A on the high side.

In addition to the inherent CT inaccuracies there are two other sources of inaccuracies for the calculated high side currents, although not expected to have considerable impact. First is the fact that, as described in III-B1, the low side coil with lost phase carry a small current for magnetization and core losses. This current will result in the calculation to provide a very small current for the lost phase on the primary side as may be recognizable in Figure 22. The second one is the transformer's magnetizing and core losses current as supplied by the high side grid. This current, which is modeled as the parallel branch in the transformer equivalent circuit, will not be considered in the calculations of primary currents.

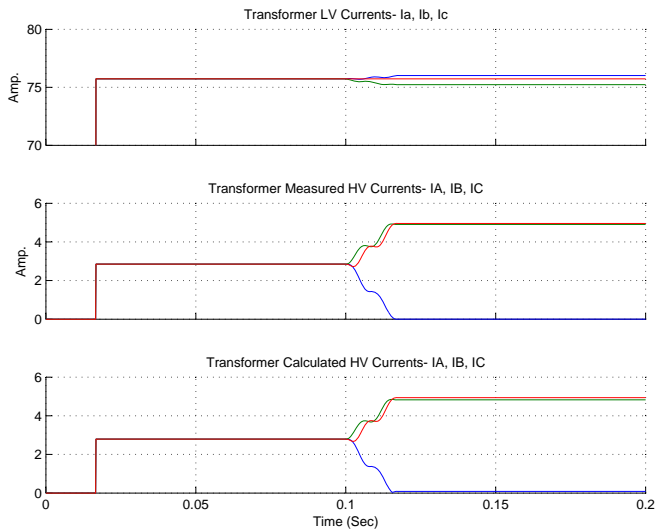

Fig. 22. Simulation Results for Measured and Calculated Primary Currents in a Y_g - Δ Transformer After Loss of Phase A- Load=60KW

B. Transformers with Ungrounded Primary (Δ or Y)

As discussed in Section III-B2 transformers with ungrounded primary winding will have major unbalance conditions upon loss of a phase such that voltage or current protection elements on the low side will detect a fault. However, those protection elements do not necessarily provide the actual cause of the fault without which the down time for investigation and finding the open phase on the primary side could be further extended.

One algorithm to identify an open phase condition in such transformers was developed in III-B2 where values of $\frac{I_2}{I_1}$ on the low side for various open phase conditions are provided in Table A. These values are consistent and applicable regardless of core construction and low side winding configuration as long as the primary side is Δ or Y . Hence Table A provides a

practical, reliable and simple tool for identification and protection of open phase conditions in these types of transformers. All values in Table A are true for DG cases and it is directly applicable to DG where there is a power generating source on the low side exporting to the grid.

Another method to identify an open phase in transformers with ungrounded primary winding is to calculate the high side currents from the low side CTs, similar to the concept used in Y_g - Δ transformers. However, since no zero sequence current is flowing from the primary to the secondary side the calculations will be much less complicated. Note that, where the low side is a Y_g configuration, there could be zero sequence current on the low side which will induce an I_0 inside the Δ winding.

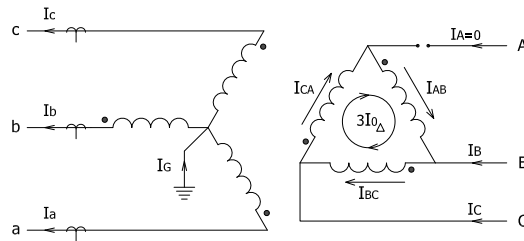

Fig. 23. Currents in a Δ - Y_g Transformer with D1 Primary

Calculation of the high side line currents from the low side CTs for a Δ - Y_g transformer is provided as an example with the transformer illustrated in Figure 23. The following set of equations apply to the currents in Figure 23, where transformer's ratio is $n = \left| \frac{V_{ABnom.}}{V_{abnom.}} \right|$.

$$\begin{aligned} I_{CA} &= \frac{1}{n\sqrt{3}} I_c \\ I_{BC} &= \frac{1}{n\sqrt{3}} I_b \\ I_{AB} &= \frac{1}{n\sqrt{3}} I_a \end{aligned} \quad (23)$$

With I_{CA} , I_{BC} and I_{AB} obtained from (23) we can now calculate the primary side line currents per below:

$$\begin{aligned} I_A &= I_{AB} - I_{CA} \\ I_B &= I_{BC} - I_{AB} \\ I_C &= I_{CA} - I_{BC} \end{aligned} \quad (24)$$

The above set of equations are true whether or not there is zero sequence current on the low side (Y_g), for instance in case of an unbalanced load. This is because any I_0 on the low side will be considered in the high side Δ coils by equation 23, although I_0 will be cancelled out in line currents by (24).

Figure 24 illustrates simulation results for the same system in Section III-B2 with an *unbalanced* total load of 100KW. Note that the unbalanced load creates zero sequence current on the low side which will be circulating inside the Δ winding coils. The calculated primary side currents identify that phase A is open.

The Δ coils may also be connected in a different way as shown in Figure 25 which will create a phase angle

shift opposite to the previous example. The following set of equations applies to the transformer currents:

$$\begin{aligned} I_{CB} &= \frac{1}{n\sqrt{3}} I_c \\ I_{BA} &= \frac{1}{n\sqrt{3}} I_b \\ I_{AC} &= \frac{1}{n\sqrt{3}} I_a \end{aligned} \quad (25)$$

The primary side line currents can then be calculated as below, which will identify an open phase condition when one of the currents is calculated as zero.

$$\begin{aligned} I_A &= I_{AC} - I_{BA} \\ I_B &= I_{BA} - I_{CB} \\ I_C &= I_{CB} - I_{AC} \end{aligned} \quad (26)$$

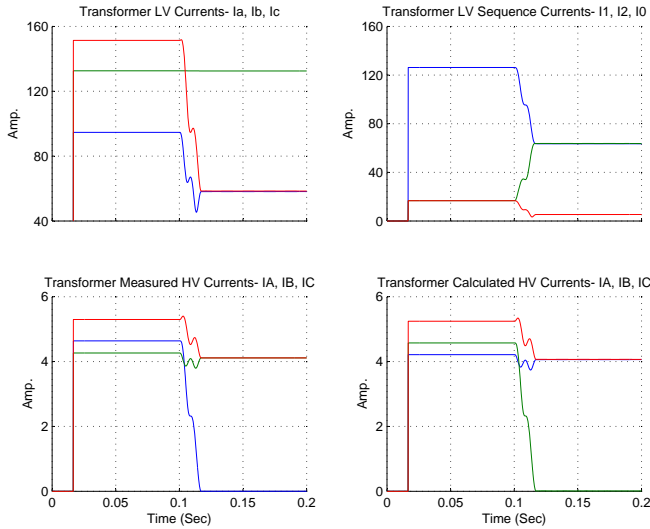

Fig. 24. Simulation Results for Measured and Calculated Primary Currents in a Δ - Y_g Transformer After Loss of Phase A- Unbalanced Load=100KW

With similar exercise primary side currents can be calculated from the low side CTs in other less commonly used transformers such as Y - Y_g or Δ - Δ which are not presented here to stay focused on the commonly used transformers. This method of calculating the high side current is also true and applicable in DG cases with direct use of the above equations.

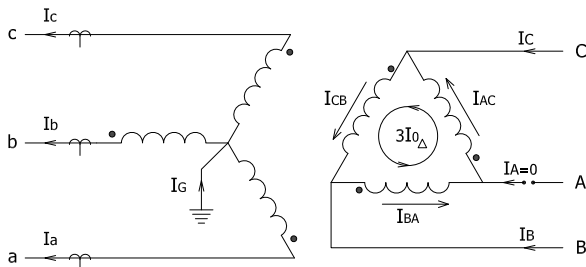

Fig. 25. Currents in a Δ - Y_g Transformer with D11 Primary

In summary, there are two reliable and effective methods for identification and protection of open phase conditions in transformers with Δ or ungrounded Y primary winding: the method of $\frac{I_0}{I_1}$ values of the low side and the method of high side current calculation. These methods may be combined as a single algorithm to provide a robust and effective way to identify an open phase condition in transformers with ungrounded primary.

C. Y_g - Y_g Transformers

Although Y_g - Y_g transformers demonstrate different characteristics in open phase conditions depending on the core type the principle of calculating the high side currents from the low side CTs provides a general method for identification and protection of open phase conditions in Y_g - Y_g transformers regardless of the physical construction.

Figure 26 illustrates a Y_g - Y_g transformer with one phase open. Positive and negative sequence currents of the transformer's primary and secondary are still governed by the transformer ratio in the new unbalanced system after loss of a phase. If $n = \left| \frac{V_{ABnom.}}{V_{abnom.}} \right|$ we will have :

$$\frac{I_{1Sec.}}{I_{1Pri.}} = \frac{I_{2Sec.}}{I_{2Pri.}} = n \quad (27)$$

However, the above is not necessarily true for the zero sequence currents in three-leg core transformers. Zero sequence magnetizing current and core losses in three-leg cores are significantly larger than that of a positive sequence model. Therefore, the parallel branch in the transformer's zero sequence model has more considerable impact, i.e. the current in the parallel branch may not be totally ignored. Hence I_0 of the two sides will have a ratio different than n . Furthermore, upon loss of a phase in a three-leg transformer, the primary side has only two phases with very high I_0 ($I_G = I_B + I_C$). However, a large portion of this zero sequence current flows in the parallel branch for zero sequence magnetization and core loss and a small portion will be induced in the secondary side. The secondary side is still a three-phase system with much smaller I_0 , although not necessarily highly balanced depending on the load size. Therefore each side will have a different I_0 that can freely circulate in each grounded side.

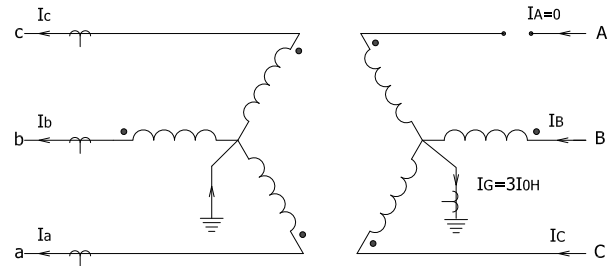

Fig. 26. Currents in a Y_g - Y_g Transformer

The reliable source of the high side zero sequence current, $I_{0Pri.}$, is again the neutral CT on the primary side of the transformer. If the high side ground current is I_G , as measured by the neutral CT in Figure 26, then we have:

$$I_{0_{Pri.}} = \frac{1}{3}I_G \quad (28)$$

With $I_{1_{Sec.}}$ and $I_{2_{Sec.}}$ calculated from the low side CT measurements, $I_{1_{Pri.}}$ and $I_{2_{Pri.}}$ are then obtained from (27). With $I_{0_{Pri.}}$ from (28) all symmetrical components of the primary currents are now available and I_A , I_B , and I_C can be easily computed. Note that there is no phase shift between primary and secondary sides of the transformer.

The above method for identification and protection of open phase conditions is valid regardless of the transformer physical construction, although Y_g - Y_g transformers will have different responses to loss of a phase depending on the core type. Using the equations provided in this section the primary side currents are calculated and an open phase will be detected. Besides, it is directly applicable to DG where a power generation source on the secondary side exports power to the grid.

Figure 27 illustrates simulation results for the same system of Figure 10 with a three-leg core Y_g - Y_g transformer. It is assumed that the transformer's zero sequence no load magnetizing current is $1pu$ with a corresponding core losses of $20KW$. Before the loss of phase A at $t = 0.1Sec.$ transformer is loaded at $120KW$.

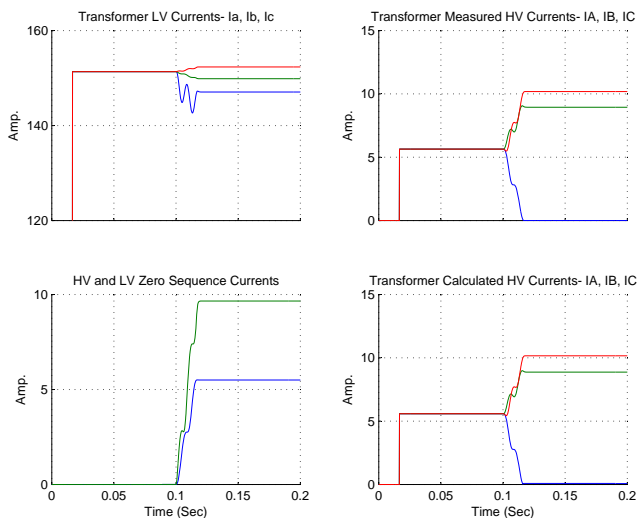

Fig. 27. Simulation Results for Measured and Calculated Primary Currents in a Three-leg core Y_g - Y_g Transformer After Loss of Phase A- Load=120KW

After open phase condition the low side is fairly balanced with $\frac{I_{2_{Sec.}}}{I_{1_{Sec.}}} = 7.4\%$. Note to the zero sequence currents that are not governed by the transformer ratio with $I_{0_{Pri.}} = 5.49A$ and $I_{0_{Sec.}} = 9.65A$. Regardless of the core type the method will accurately calculate the high side currents from the low side and neutral CTs, although in four/five leg core type or bank of three single phase transformers the low side will not be balanced with one phase completely lost. Besides, in those types of transformers the turn ratio is actually applicable to $I_{0_{Pri.}}$ and $I_{0_{Sec.}}$. Here the magnetization and core loss currents in the parallel branch of the transformer's zero sequence model is not different from positive or negative sequence models.

V. CONCLUSION

Open phase conditions in three-phase transformers present a challenge for power system operation and protection, particularly in distribution networks. With more Distributed Generation deployed the challenge can become more complicated. Proper and effective identification and protection methods help improve the power system reliability and performance. This paper discussed that how and why standard or traditional protection elements cannot always detect an open phase in transformers, particularly in lower loadings. Three major transformer configurations were identified with each group responding differently to loss of a phase. In fact different electrical or magnetic mechanisms are at work in each of the three transformer groups upon loss of a single phase. While in transformers with ungrounded primary winding there will be substantial unbalance conditions with one phase open on the high side in transformers with Y_g primary the system may still be fairly balanced on the low side. For each group of transformers a method was developed for effective identification of the lost phase and therefore protection of the transformer upon open phase conditions. Hence a protection algorithm can be established to address open phase conditions in each group of transformers. The presented methods are universally applicable to DG cases as well where a power generating source on the low side of the transformer exports power to the grid. Digital simulation was performed for several types of transformers to illustrate a transformer's response to an open phase as well as to demonstrate the operation of the protection methods presented in this paper.

REFERENCES

- [1] A.E. Fitzgerald, C. Kingsley Jr. and S.D. Umans, *Electric Machinery*, 4th ed. McGraw-Hill, 1983.
- [2] Stephen J. Chapman, *Electric Machinery Fundamentals*, 4th ed. McGraw-Hill, 2005.
- [3] J. Lewis Blackburn, Thomas J. Domin, *Protective Relaying- Principles and Applications*, 3rd ed. CRC Press, 2006.
- [4] John Horak and Gerald F. Johnson, *A Practical Guide for Detecting Single-Phasing on a Three-Phase Power System*, Western Protective Relay Conference, 2002.
- [5] Jialong Wang and Raluca Lasca, *Zero Sequence Circuit of Three-legged Core Type Transformers*. (Basler Electric)
- [6] E. L Harder, *Sequence Network Connections for Unbalanced Load and Fault Conditions*, The Electric Journal, December 1937.
- [7] Paul M. Anderson, *Analysis of Faulted Power Systems*, IEEE Press, 1995.

Amir Norouzi received his B.Sc degree from Tehran Polytechnic in 1996 and his M.Sc from the University of New Brunswick, NB, in 2003 both in electrical engineering. He has 13 years of experience in power system engineering including substations, industrial applications, power generation and distribution. He joined GE Digital Energy in Markham, Ontario, in 2011 as a technical application engineer, focusing on providing system solutions in protection and control.