

Protection System for Phase-Shifting Transformers Improves Simplicity, Dependability, and Security

Michael Thompson, *Schweitzer Engineering Laboratories, Inc.*

Abstract—Phase-shifting transformers (PSTs) are used to control power flow on the transmission system. They work by inserting a variable magnitude quadrature voltage into each phase to create a phase shift between the source- and load-side bushings by the use of a tap changer on the regulating winding. Proper transformer protection requires matching ampere-turns (ATs) on core leg loops of the transformer. In a traditional transformer, the AT unbalance introduced by a tap changer is typically in the range of ± 10 percent, which is easily accommodated by the slope of the differential element. In a PST, the range of AT unbalance on the core of the regulating winding is in the range of ± 100 percent. For this reason, many protection systems do not attempt to match ATs and use only the Kirchhoff's current law type of differential elements, which are unable to detect turn-to-turn faults, reducing dependability. Systems that do match ATs require the adjustment of the differential element in real time using a mechanical indication of the tap changer position, increasing complexity. This mechanical measurement can be unreliable, resulting in misoperation of the scheme and reducing security. In addition, the mechanical position indication is often not easily available to the protective relay. This paper summarizes present protection recommendations and their limitations for the three most common types of PSTs. The paper then reports on the further development of a differential element that has been in successful use for many years, is sensitive to all fault types (including turn-to-turn faults), and can be applied to any type of PST using only current transformers (CTs) on the source and load sides of the PST zone. The new development provides a real-time electrical measurement of the phase shift for angle compensation.

I. INTRODUCTION

Phase-shifting transformers (PSTs) are used to control power flow on the transmission system. They work by inserting a variable magnitude quadrature voltage into each phase to create a phase shift between the source- and load-side bushings by the use of a tap changer on the regulating winding.

The simplified equation (neglecting losses and shunt admittances) for the power flow through a transmission line is shown in (1) [1]:

$$P = \frac{E_S \cdot E_R}{X_L} \sin \delta \quad (1)$$

where:

E_S is the sending-end voltage.

E_R is the receiving-end voltage.

X_L is the series reactance of the transmission line.

δ is the angle between the two voltages.

Examination of this equation reveals that power flow is largely a function of the angle between the two voltages. If the

angle across the line can be regulated, the power flow through the line can be regulated. By introducing an angle that is additive (advance), power flow can be increased. By introducing an angle that is subtractive (retard), the power flow can be reduced. When the power system is operated more closely to its limits, PSTs are a good way to optimize the utilization of existing transmission line assets. Thus we are seeing PSTs become more common on the power system.

Proper transformer protection requires matching ampere-turns (ATs) on core leg loops of the transformer [2]. In a traditional transformer, the AT unbalance introduced by a tap changer is typically in the range of ± 10 percent, which is easily accommodated by the slope of the differential element. In a PST, the range of AT unbalance on the core of the regulating winding is in the range of ± 100 percent. For this reason, many protection systems do not attempt to match ATs and use only the Kirchhoff's current law type of differential elements, which are unable to detect turn-to-turn faults, reducing dependability. These systems rely on the 63 sudden pressure relay (63SPR) or Buchholz relay exclusively for turn-to-turn fault protection in all or part of the PST windings. Going forward, this paper uses 63SPR to indicate both sudden pressure and Buchholz types of protection.

Further, many of the accepted practices for protecting PSTs require current transformers (CTs) to be placed inside the tank of the transformer. Placing CTs inside the tank can increase the complexity of the insulation system of the PST, reducing the reliability of the transformer. CTs inside the tank can also be subject to proximity effects (unless properly shielded) that can cause false currents to the relays and relay misoperation.

This paper summarizes present practices for protecting PSTs and identifies deficiencies. But the main focus of the paper is a report on the further development of a differential element that has been in successful use for many years, is sensitive to all fault types (including turn-to-turn faults), and can be applied to any type of PST using only CTs on the source and load sides of the PST zone. The new development provides a real-time electrical measurement of the phase shift for angle compensation.

II. PROTECTION FOR VARIOUS TYPES OF PSTS

There are several resources available for an engineer wishing to design a protection system for a PST. IEEE C57.135, IEEE Guide for the Application, Specification, and Testing of Phase-Shifting Transformers, briefly covers protection of PSTs [3]. The information is not very complete.

The IEEE PES Power System Relaying Committee has an active working group (WG K1) with an approved Project Authorization Request (PAR) to develop IEEE C37.245, Guide for the Application of Protective Relaying for Phase Shifting Transformers. This work is presently just getting started.

Perhaps the most authoritative resource available is the IEEE special publication "Protection of Phase Angle Regulating Transformers: A Report to the Substation Subcommittee of the IEEE Power System Relaying Committee," prepared by Working Group K1 and published in 1999 [4]. This special publication covers traditional practices of PST protection and does not include advances in modern numerical relays.

A. Types of PSTs

There are three main types of PSTs in common usage today. IEEE C57.135 illustrates a number of variations on these configurations, but the main considerations are whether the design includes a single core or two cores and the winding configuration to insert the quadrature voltage between the source- and load-side bushings. Another attribute that describes a PST is whether it is symmetrical or not. A symmetrical PST will introduce no change in voltage magnitude between its source- and load-side bushings when the tap changer is off neutral [5].

IEEE C57.135 does not identify the configurations by name, so they are identified by their common names in the following figures.

Fig. 1 shows an extended-delta PST. This type of PST can be symmetrical with two regulating windings and two tap changers, as shown in Fig. 1, or nonsymmetrical with only one regulating winding and tap changer. To maintain symmetry when two tap changers are used, the two tap changers are often interlocked such that they take alternating steps from neutral to maintain no more than one step off of symmetry. This is a single-core design.

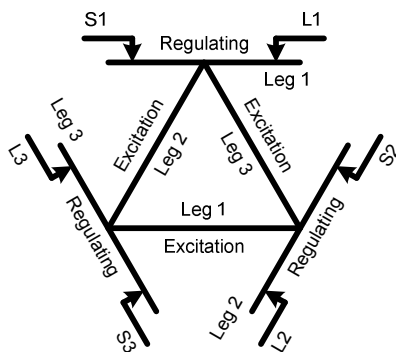

Fig. 1. Extended-delta single-core PST

Fig. 2 shows a delta/hex PST. This is also called a squashed-delta PST. This type of PST can be symmetrical with two tap changers, as shown in Fig. 2, or nonsymmetrical with only one tap changer. To maintain symmetry when two tap changers are used, the tap changers are often interlocked such that they take alternating steps from neutral to maintain

no more than one step off of symmetry. This is a single-core design.

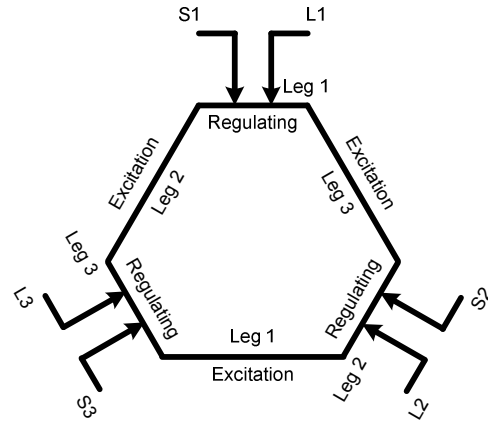

Fig. 2. Delta/hex single-core PST

Fig. 3 shows a conventional two-core PST. This type of PST is symmetrical.

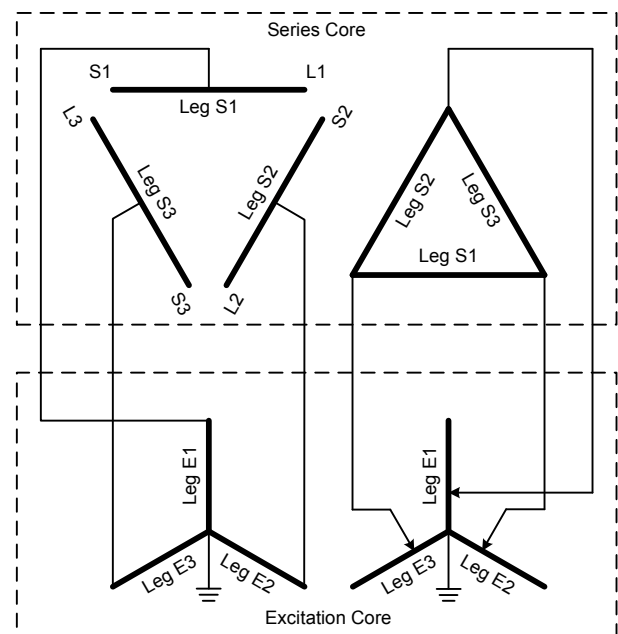

Fig. 3. Conventional two-core PST

B. Single-Core PST Protection

Single-core PSTs, such as the extended-delta and the delta/hex PST illustrated in Fig. 1 and Fig. 2, are typically protected by the Kirchhoff's current law type of differential zones. A bus differential relay without harmonic restraint can be applied here because these differential zones do not match ATs on core leg loops and are not subject to magnetic core effects, such as inrush and overexcitation.

A six-zone low-impedance bus differential relay can be applied to isolate current into each winding of the PST. Fig. 4 shows how the zones would be configured for a delta/hex PST. An extended-delta PST would be similar.

Note that the CTs inside the delta define the boundary between two zones. So the bus differential relay has to have

the ability to assign each of these six inside-the-delta CTs to two zones (one exciting winding zone and one regulating winding zone). Depending on how the polarity of the CT circuit is wired (towards the exciting winding or towards the regulating winding), the bus relay must have the capability to reverse the polarity to one of the two zones that it is applied to. Alternatively, if the CTs are wired with polarity towards the regulating winding zone, the excitation winding zones can be simply defined as the polarity of both CTs out of the zone to obtain proper differential polarity.

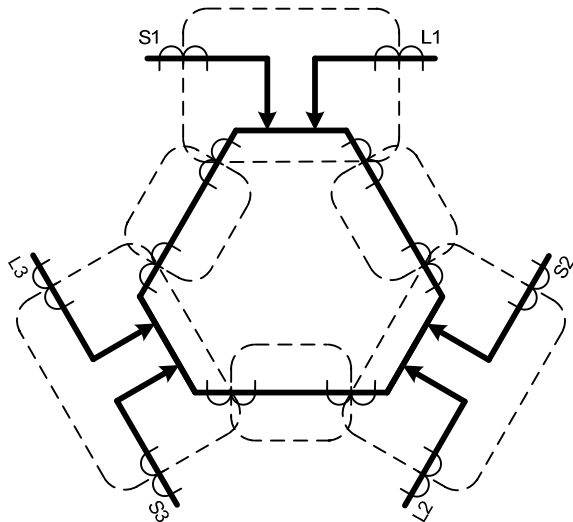

Fig. 4. Differential protection for single-core PST, 87P

This scheme will respond with high speed to any winding-to-winding or winding-to-ground fault and should be included for this reason. Because this is not an AT balance differential, this protection cannot detect turn-to-turn faults. The 63SPR relay covers turn-to-turn faults.

Overlapping directional overcurrent and/or distance element-based protection can also be applied in a permissive overreaching transfer trip (POTT) scheme to supplement the differential protection. We will see later that this scheme can also be used to address saturation of the series (regulating) winding issues [6].

C. Two-Core PST Protection

Two-core PST protection requires two differential relays to provide relatively complete protection. They are designated as the primary and secondary differentials. However, these two differential relays are not fully redundant to each other.

1) Primary Differential Protection, 87P

The primary differential protection is a Kirchhoff's current law differential zone that covers the primary of the series core and the primary of the exciting core windings. Fig. 5 shows the coverage of the differential zone.

A bus differential relay without harmonic restraint can be applied here because these differential zones do not match ATs on core leg loops and are not subject to magnetic core effects, such as inrush and overexcitation. Either low-impedance percentage restrained bus differential relays or high-impedance bus differential relays can be applied here.

This scheme will respond with high speed to any winding-to-winding or winding-to-ground fault and should be included for this reason. Because this is not an AT balance differential, this protection cannot detect turn-to-turn faults.

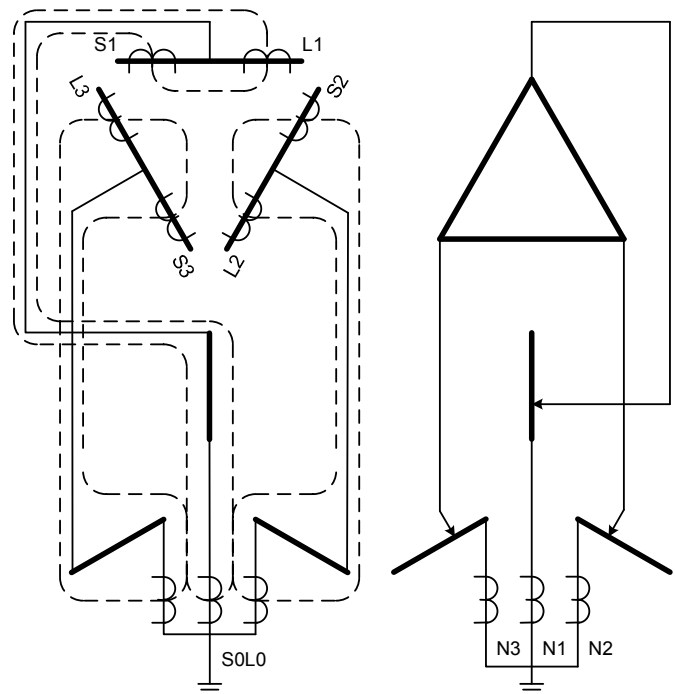

Fig. 5. Primary differential protection for two-core PST, 87P

2) Secondary Differential Protection, 87S

The secondary differential protection is an AT balance differential for the windings on the series core. Refer to Fig. 3 to see which windings these are. Notice that the tap changer operates on the excitation core secondary winding to adjust the voltage applied to the secondary of the series core winding. The number of turns on the series winding core is fixed.

The relay used for this protection must be a three-restraint transformer differential relay. One way to envision the setup and operation of this relay is to think of it as a three-winding transformer with one delta winding and two wye windings. Fig. 6 is the PST shown in Fig. 3 but with the series core windings rearranged into a more familiar arrangement. We can look at the windings of the excitation core as simply conductors that connect the series windings to their respective bushing CTs and ground.

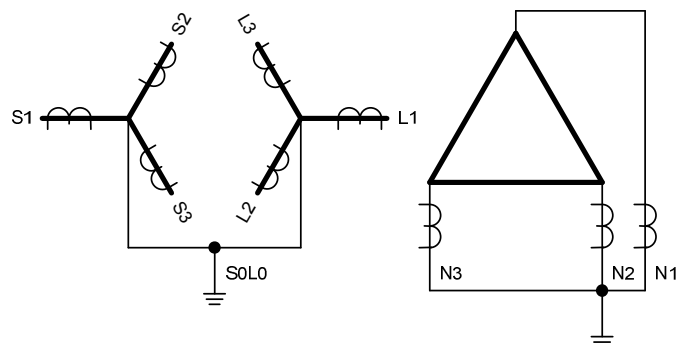

Fig. 6. Secondary differential protection for two-core PST, 87S

This differential would be set up with the N bushing CTs using Matrix 0 compensation (no phase shift), the S bushing CTs using Matrix 9 compensation, and the L bushing CTs using Matrix 3 compensation. The angle compensation matrixes are numbered by the positions on the clock. Matrix 0 corresponds to the 12 o'clock position. Matrix 3 compensates a phase shift of 90 degrees lagging, and Matrix 9 compensates a phase shift of 90 degrees leading.

This scheme will respond to any winding-to-winding or winding-to-ground fault as well as turn-to-turn faults in the windings on the series core. Any fault in the primary of the excitation winding will be out of zone. Any fault in the secondary of the excitation winding will be detected if it goes winding to winding or winding to ground. However, this protection will not detect to turn-to-turn faults in the excitation windings. Turn-to-turn faults in the excitation windings are only covered by the 63SPR relay.

The difficult part is determining the tap factors for each of the CT inputs. The tap factors have to be chosen with a knowledge of the number of turns in each winding.

When calculating tap values for a conventional power transformer, the voltage rating of each winding is used as a surrogate for turns in developing the AT balance differential equations. The well-known equation for tap, (2), relates MVA and volts to amperes. The turns equal out in this equation because the volts per turn is the same for each winding on each core leg.

$$\text{TAP}_n = \frac{1000 S_{\text{MAX}} C}{\sqrt{3} V_n \text{CTR}_n} \quad (2)$$

where:

S_{MAX} is the maximum transformer capacity in MVA (must be the same for all TAP_n calculations).

V_n is the line-to-line rated voltage of transformer Winding n in kV.

CTR_n is the ratio of the CTs connected to Winding n .

C is a factor that corrects the effective CT ratio, considering the CT circuit connection. For CTs connected in delta, $C = \sqrt{3}$. For CTs connected in wye, $C = 1$.

For this application, (2) can be used to calculate tap values for the S and L bushing CTs. This puts the tap values on the per-unit base for the transformer. Use the PST MVA rating for S_{MAX} and the V_{LL} rating for V_n .

The voltage rating to use in (2) for the N bushing CTs is related to the voltage used in (2) for the S and L bushing CTs by the turns ratio of the series winding using (3). This voltage rating is not the actual voltage rating of the winding. It is only a mathematical construct to put all calculations on the same base.

$$V_{\text{N_Bushing}} = \left(\frac{V_{\text{SL_Bushing}}}{\sqrt{3}} \right) \cdot \left(\frac{T_S}{0.5 \cdot T_P} \right) \quad (3)$$

where:

$V_{\text{N_Bushing}}$ is the voltage in kV_{LL} to insert into (2) to calculate the tap value for the N bushing CTs.

$V_{\text{SL_Bushing}}$ is the voltage in kV_{LL} of the PST that was used in (2) to calculate the tap value for the S and L bushing CTs.

T_S is the number of turns in the secondary of the series winding.

T_P is the number of turns in the primary of the series winding.

In (3), T_P is multiplied by 0.5 because the currents measured by the S and L bushing CTs represent the current in half of the turns of the primary winding, as is readily apparent by examination of Fig. 6. $V_{\text{SL_Bushing}}$ is divided by $\sqrt{3}$ to account for the delta connection of the secondary winding.

D. Why Are Turn-to-Turn Faults a Concern?

Partial winding faults are a unique issue with transformers [2]. They are of particular concern to single-core PSTs where the tap changer and tap board leads and connections are in the series circuit between the S and L bushings of the PST. A fast transient such as can occur during capacitor bank switching or lightning surges can pass through the series winding and cause a flashover between taps. The previous sections of this paper indicated that present protection recommendations do not detect turn-to-turn faults in single-core PSTs and in the excitation core windings of two-core PSTs. In the past, it was necessary to rely on the 63SPR relay to detect this type of fault. The fault must have already developed to be significant before this protection will operate.

To provide turn-to-turn fault protection, it is necessary to balance ATs in core leg loops inside the transformer. To obtain this balance on a PST regulating winding, it is necessary to adjust the phase compensation matrixes with noninteger values for each operating position of the tap changer. Reference [2] provides an example for an extended-delta PST where factor D (the position on the winding from neutral) is used to adjust the compensation. To develop an AT balance for a delta/hex transformer is even more complex because the current in the regulating winding is divided into three segments.

While there are modern microprocessor-based transformer relays available that can do this in real time, it requires reading the tap position from the tap changer into the relay. This makes the application of such a protection scheme complex and can lead to loss of security for a bad tap position reading.

The improved protection system, based on a protection system with a proven track record, that is discussed in the next section provides the required protection for turn-to-turn faults while reducing the complexity of adjusting AT balance equations in real time and eliminating the possibility of misoperation due to an error in reading the tap position.

III. SEQUENCE COMPONENT PST DIFFERENTIAL PROTECTION

The sequence component PST differential protection principle is elegant in its simplicity. The development and refinement of the principle are described in full detail in [7]. Further, a rigorous mathematical proof that the negative-sequence differential element is mathematically consistent

with the AT balance differential element is contained in Section VI of [2].

The scheme makes use of a fundamental attribute of symmetrical component theory. Simply, when a transformer introduces a phase shift, the negative-sequence component is shifted the opposite of the positive-sequence component. This is true whether the phase shift is an integer multiple of 30 degrees, as in a conventional transformer, or a variable phase shift, as in a PST.

The sequence component PST differential protection system extracts the positive-sequence component and the negative-sequence component of the source- and load-side currents. These currents are then put in per unit by dividing by tap compensation factors, as is common practice with any type of transformer differential protection system.

The load-side I_1 (I_{1L}) and I_2 (I_{2L}) phasors are adjusted by an angle compensation factor to cancel out the phase shift introduced by the PST. I_{1L} is shifted by subtracting the angle compensation factor from the measured I_{1L} angle. I_{2L} is shifted by adding the angle compensation factor to the measured I_{2L} angle. This places I_{1L} at approximately 180 degrees relative to I_{1S} and I_{2L} at approximately 180 degrees relative to I_{2S} . From here, operate and restraint quantities for the 87-1 positive-sequence differential element and 87-2 negative-sequence differential element are calculated by (4) through (7).

$$I_{1OP} = I_{1S} + I_{1L_COMP} \quad (4)$$

$$I_{1RST} = \frac{|I_{1S}| + |I_{1L_COMP}|}{2} \quad (5)$$

where:

I_{1OP} is the operate quantity for the 87-1 element.

I_{1S} is the source-side positive-sequence current phasor.

I_{1L_COMP} is the load-side positive-sequence phasor after being adjusted by the angle compensation factor.

I_{1RST} is the restraint quantity for the 87-1 element.

$$I_{2OP} = I_{2S} + I_{2L_COMP} \quad (6)$$

$$I_{2RST} = \frac{|I_{2S}| + |I_{2L_COMP}|}{2} \quad (7)$$

where:

I_{2OP} is the operate quantity for the 87-2 element.

I_{2S} is the source-side negative-sequence current phasor.

I_{2L_COMP} is the load-side negative-sequence phasor after being adjusted by the angle compensation factor.

I_{2RST} is the restraint quantity for the 87-2 element.

The operate and restraint quantities are then checked against a dual-slope differential characteristic to determine if there is an internal fault.

The original invention used a mechanical indication of the tap changer position to calculate the angle compensation factor [8]. To improve the security of the scheme, the implementation included logic to measure the angle shift between the source- and load-side voltages and to alarm if the mechanical indication was inconsistent with the measured angle shift. Later, we will see how the angle compensation logic has been changed to use electrical measurement of the phase shift to improve simplicity and security.

The sequence component differential element is supervised by various additional elements to provide security for well-known transformer differential element challenges, such as inrush and overexcitation.

The original scheme was also supervised by directional elements to prevent misoperation for severe through faults where saturation of the series winding could occur or where CT saturation could result in false unbalance currents [6]. For this reason, it required two relays to implement.

IV. OPERATING EXPERIENCE WITH SEQUENCE COMPONENT PST DIFFERENTIAL PROTECTION

After only a few years in service, one of the three PSTs reported on in [7] experienced an internal turn-to-turn fault caused by a capacitor switch restrike on a capacitor bank adjacent to the PST. The resultant fast transient caused a flashover of the tap board leads inside the PST. The redundant bus differential relays applied to protect the six individual windings did not respond as expected. The sequence component PST differential protection system tripped the PST before enough energy was dissipated inside the tank for the 63SPR relay to sense the fault. The result was very minimal damage to the PST, allowing it to be repaired and returned to service.

Fig. 7 shows the oscillographic recording of the fault and subsequent trip. The pre-fault load flow was approximately 50 MVA, or 33 percent of the PST rating. The PST was on one-step retard (-2.1 degrees) at the time of the fault. The W currents are the source-side currents, and the X currents are the load-side currents. The Y voltages are the load-side voltages. PSV30 is the pickup of the positive-sequence differential element (87-1), and PCT01Q is the trip of the 87-1 element. PSV40 is the pickup of the negative-sequence differential element (87-2), and PSV02Q is the trip of the 87-2 element. The trip came up in less than 1.5 cycles with a total clearing time of 4 cycles.

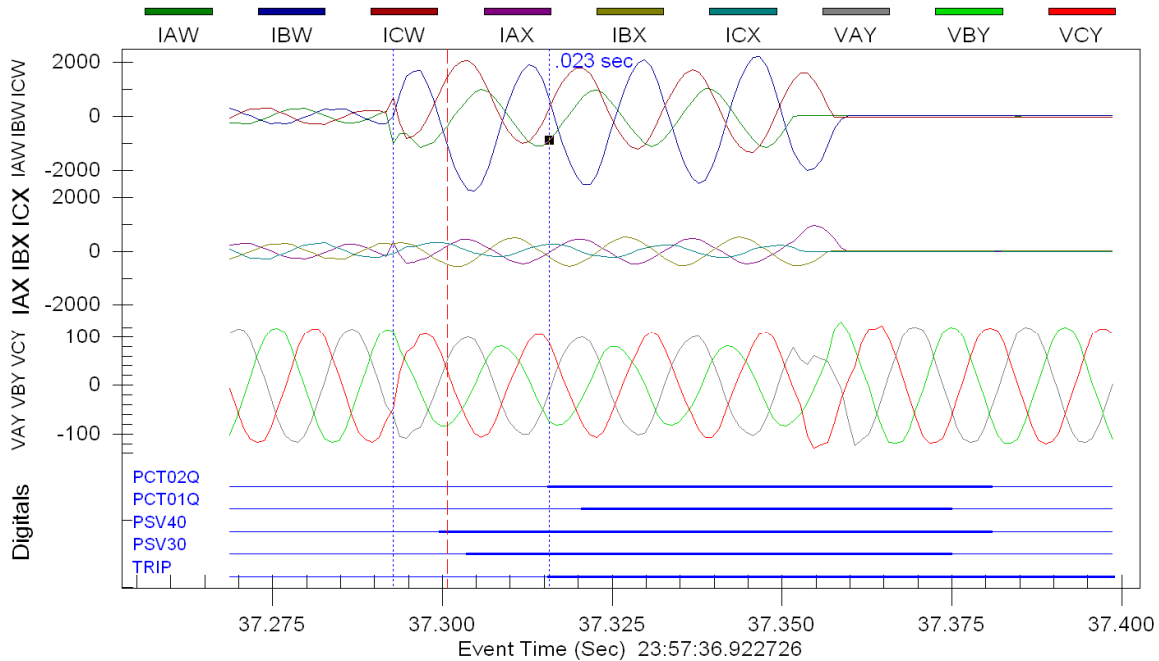

Fig. 7. Turn-to-turn fault in delta/hex PST during capacitor switching transient

While this scheme has only been called upon to trip for one actual faulted PST, it is in service on more than 10 single-core PSTs of both extended-delta and delta/hex configurations. The first went in service in 2006, and the scheme has a perfect operating history. There have been no security (false trip) failures over the course of many through faults, and there have been no dependability failures (fail to trip) in service.

V. NEW DEVELOPMENTS

The original sequence component PST differential scheme was enhanced using a new protective relay platform that enabled the scheme to be implemented in a single relay instead of the two relays previously required. The new platform includes many built-in transformer protection features that are used to improve performance, reduce complexity, reduce cost, and widen the number of transformers that the scheme can be implemented on.

One of the requirements for the improved scheme was to eliminate the need to mechanically read the tap changer position into the protection system. In many cases involving retrofitting, this was simply not easily accommodated. In addition, there was one case where the end user experienced misoperation of an AT balance differential scheme on a single-core PST due to failure of the tap changer reading mechanism. The end user was motivated to install a system that did not require this weak link in the system.

Fig. 8 shows a typical single-line diagram of the improved PST protection system. The relay requires only three-phase current on the source and load sides of the zone of protection and no CTs inside the tank. It also requires three-phase

voltage on the source and load sides of the zone of protection. The PST in the protected zone can be a single-core PST, as shown in Fig. 8, or a two-core PST. In a two-core PST, the relay would also include measurement of the N bushing CTs to implement the traditional 87S protection zone in addition to the sequence component PST differential protection.

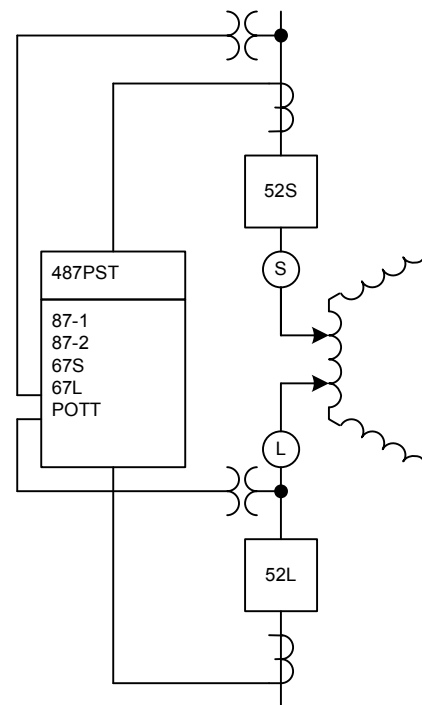

Fig. 8. Single-line diagram of PST protection system

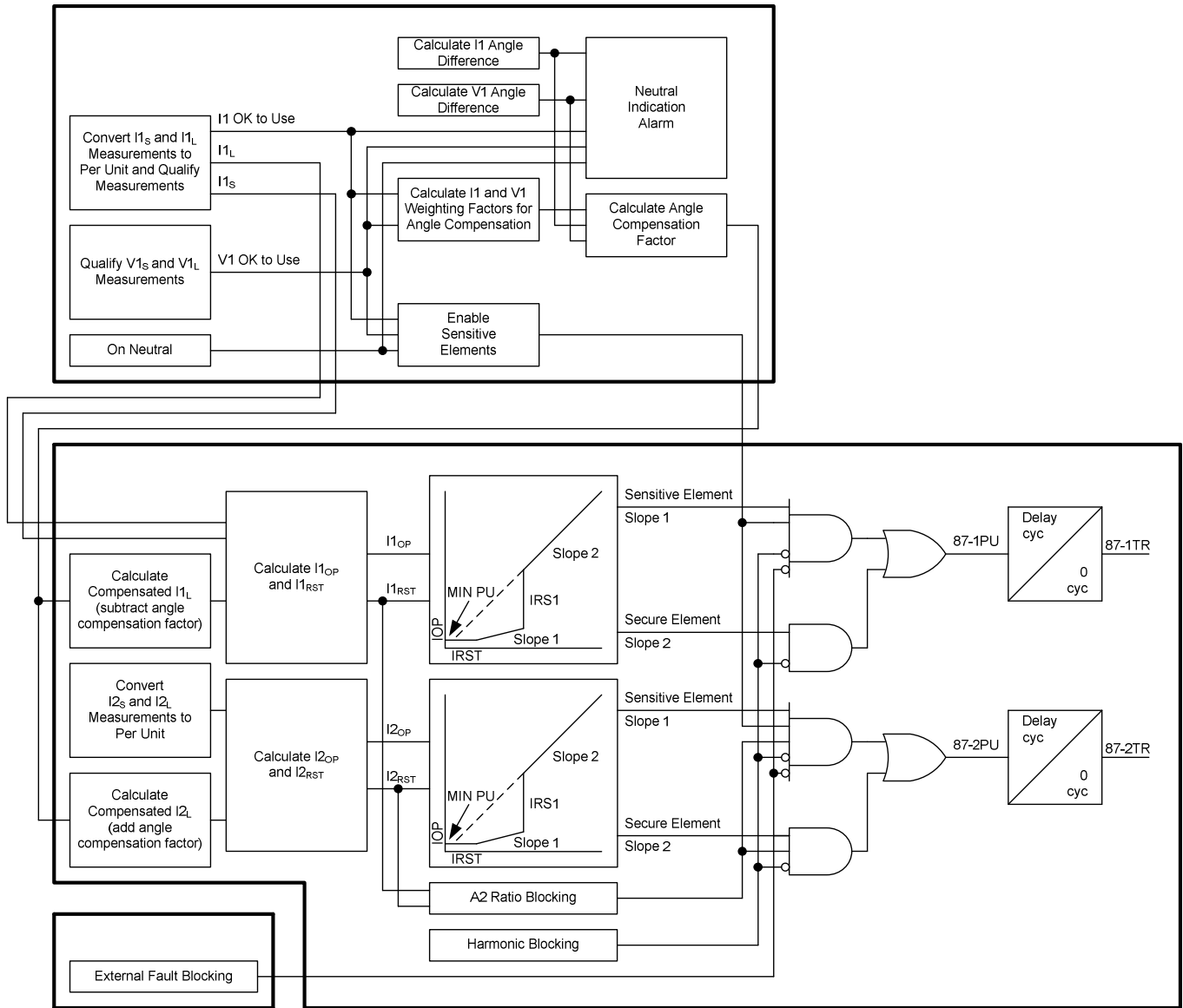

Fig. 9. Functional block diagram of PST differential protection system

Fig. 9 is the functional block diagram of the sequence component PST protection system.

A. Angle Compensation

The relay has measurements of both the source- and load-side currents and voltages. These measurements are used for both the angle compensation and the directional elements that are used to determine if a fault is internal or external to the zone of protection.

During normal load flow, the current through the PST is mostly positive sequence. During conditions of low load flow, the I1 angle shift measurement is not reliable. During high load flow conditions, the V1 angle shift measurement is less accurate than the I1 measurement due to the voltage drop across the PST. The angle compensation factor is calculated using a weighting method. Fig. 10 shows the characteristic. When the I1 load flow is less than a minimum threshold, which is set to around 0.5 A secondary, the I1 measurement is weighted as 0. The V1 weighting factor is 1 minus the I1

weighting factor so that the total always sums to 1. As the I1 load flow increases, the I1 weighting factor is increased.

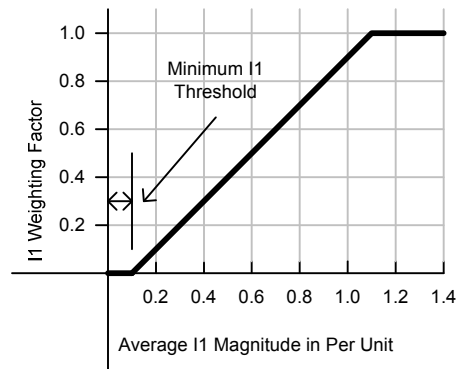

Fig. 10. I1 versus V1 angle measurement weighting factor

In the example shown in Fig. 10, the minimum threshold to use I1 is set to 10 percent. Below 10 percent load flow, the relay uses 100 percent of the V1 angle measurement for

compensation. At full load, the weighting factors are 10 percent V1 angle and 90 percent I1 angle. The weighted angle measurement is also run through a smoothing filter so that there are no sharp changes in the angle compensation factor.

The angle compensation factor is frozen when the I1 current through the PST is above a threshold. This threshold is typically set at 200 percent of the PST rating. The reason for freezing the angle compensation factor during faults is to prevent the angle compensation factor from being corrupted by filter transients. A discrete window filter such as a Fourier filter or cosine filter used for estimating the phasor magnitude and angle of the power system quantities is only valid for continuous signals. During a fault, the filter contains samples from two different states of the power system—prefault and faulted. The resultant filter transient is especially significant to the sequence component filters where the currents and voltages are phase-shifted by the factor $a = e^{j120^\circ}$. The delay timers in Fig. 9 are included to ride through the filter transient for this same reason.

In some cases, the electrical measurement is not suitable for compensating the differential currents. This might occur if one or the other of the voltage transformer (VT) signals is in loss-of-potential (LOP) alarm and the load flow is not adequate to use I1. Or, when first energizing a PST, one or both of the VT signals may be in zone and therefore de-energized. Another case would be if the zone is configured as in the Fig. 8 example. When 52S is open, there is no load flow, so I1 cannot be used. And the angle difference measured between the two VTs is the system angle and not the PST angle. Of course, the PST will always have a neutral indication contact. When the PST is on neutral, the angle compensation factor is forced to zero and electrical angle measurements are not used. It is normal practice to energize a PST while on neutral.

To deal with conditions where the angle compensation factor cannot be measured, the relay uses an adaptive slope differential element that includes a sensitive Slope 1 and a secure Slope 2 as shown in Fig. 9. The secure slope is in service all of the time. It should be set based upon the worst-case differential current that would occur if the PST is operated at extreme tap, but with no angle compensation. The sensitive slope is only enabled after a time delay after the relay has a suitable angle compensation measurement.

To further improve the ability of the relay to compensate and enable the sensitive differential element, there is some additional logic used to supplement the characteristic shown in Fig. 10. If the I1 current is above the minimum threshold and one of the VT signals is in LOP alarm, the relay adjusts the weighting factors to use 100 percent of the I1 angle measurement for compensation.

B. Harmonic Blocking

To keep the differential elements secure from operating on inrush, harmonic blocking is used, as is common for many transformer differential relays. It is important to note that, when energizing a PST with no load, the restraint

characteristic and proper compensation for phase shift are not relevant. The differential zone has only one current flowing into it. To provide harmonic blocking, the uncompensated phase differential elements in the transformer differential relay platform used are set up for the purpose of using the standard harmonic blocking features of the relay. The fifth-harmonic blocking elements are also enabled and used to prevent misoperation during overexcitation conditions.

Another thing to note is that harmonic blocking elements work on the ratio of harmonic in the operate current to fundamental in the operate current. During conditions of load flow at advance or retard angles, there is a false operate current in the phase elements because there is no phase compensation. But the ratios of harmonic to fundamental for the purpose of the blocking elements remain the same. So they are reliable—even if the PST is energized under load and off neutral.

C. High-Security Mode for External Faults

An adaptive restraint differential relay has two slope characteristics. Typically, an external fault detector is used to switch the relay from its sensitive slope to its secure slope when an external fault is detected. During severe through faults, false differential current caused by CT saturation is much more likely.

In the case of a current differential relay, it is desirable to use current measurements only for detecting an external fault. The typical method is to measure an increase in IRST without a similar increase in IOP. The relay used in this protection system has such an algorithm. However, because the conventional phase differential elements are not properly phase-compensated, this method is not suitable as an external fault detector to switch the differential characteristic into high-security mode.

Because the relay needs voltage measurements to do the angle compensation, it is suitable to use traditional phase directional overcurrent elements on the source and load sides of the zone of protection to detect an external fault and block the sensitive differential elements while leaving protection in service using the secure slope.

D. High-Security Mode for Series Winding Saturation

Another concern with PSTs is series winding saturation during an external fault. The current flowing through the regulating winding on the faulted phase will be high. If $I_F \cdot X_T$ exceeds the volts-per-turn limit on that core leg, it will saturate. Saturation will result in high current in the exciting winding of the same core leg. This will likely cause misoperation of the differential elements. The reverse directional overcurrent elements on the source- and load-side terminals place the relay in high-security mode, which helps it accommodate the possibility of series core saturation.

The problem is always obtaining any information about the volts-per-turn limits of the iron core of the PST. The question of series saturation being a problem for this application is rarely easily answered. However, because the relay needs voltage information to determine the angle compensation factor, it has directional elements on each terminal readily

available, and the directional elements are used for the adaptive slope of the differential protection system, it is recommended to set the external fault detector elements based upon conservative assumptions to prevent misoperation if series saturation should occur.

VI. PST PROTECTION GUIDELINES

A. Recommended Protection Packages for PSTs

1) Single-Core PSTs

It is recommended to apply two relays for comprehensive protection of a single-core PST. For simplicity, the two relays are designated as 87P and 87S to be consistent with the terminology used for two-core PSTs.

The 87P relay should be a Kirchhoff's current law type of low-impedance bus differential relay with six zones, as described in Section II, Subsection B. The regulating winding zone often also includes the bus leads between the circuit breakers and the PST terminals. Alternatively, a separate bus differential relay can be applied for the bus lead zones, as was the case in the application described in [7], to more easily determine if a fault is internal to the PST tank or external to the tank but in the tripping zone.

The 87S relay should be a sequence component PST differential relay with two three-phase sets of voltage inputs and two three-phase sets of current inputs. The relay should include directional elements on both terminals to implement the complete PST differential protection scheme described in Section III through Section V.

2) Two-Core PSTs

It is recommended to apply two relays for comprehensive protection of a two-core PST. The protection consists of the traditional recommendation for 87P and 87S relays supplemented with the PST differential protection scheme described in Section III through Section V.

The 87P relay should be a Kirchhoff's current law type of low-impedance bus differential relay with three zones, as described under "Primary Differential Protection, 87P" in Section II, Subsection C. The primary series core and excitation core winding differential zone often also includes the bus leads between the circuit breakers and the PST terminals. Alternatively, the six zones available in the bus differential relay can be applied to separate the bus lead zone on one side of the PST to more easily determine if a fault is internal to the PST tank or external to the PST tank but in the tripping zone.

The 87P relay can also include ground backup overcurrent protection if it is also connected to the S0L0 bushing CT or the residual of the three CTs inside the tank at the neutral end of the primary excitation core winding. This ground backup element can be applied if the excitation core of the PST is a three-legged core and has a phantom tertiary effect that supplies zero-sequence fault current to system faults. Four-legged core designs should have a high zero-sequence impedance so that a ground backup relay is not required.

The 87S relay should be an AT balance transformer differential relay with three restraint inputs and around-the-

clock internal phase shift compensation, as described under "Secondary Differential Protection, 87S" in Section II, Subsection C.

The 87S relay should also be set up to include the sequence component PST differential protection described in Section III through Section V by adding connections to three-phase VTs on the source and load sides of the PST. The current connections required to implement this protection are already required for the AT balance differential protection.

The 87S relay should also include a residual ground overcurrent element on the N bushing CT inputs to the relay. This element is typically set to a sensitive setting with a short inverse characteristic because under normal conditions, no zero-sequence current should flow in this terminal into the delta-connected series core secondary winding.

3) 63SPR Protection Recommendations

The 63SPR relay should be paired with the 87P relay for both single-core and two-core PSTs. The 63SPR should not be wired to trip through the same lockout relay as the 87S relay. The combination of the Kirchhoff's current law differential protection in the 87P relay for all faults except turn-to-turn faults with the ability of the 63SPR relay to detect turn-to-turn faults makes this scheme complementary to the 87S protection system.

4) Circulating Current Protection, 32CC

If the PST includes a bypass breaker, it is recommended to include a protection element that can detect circulating current if the PST is accidentally bypassed off neutral. None of the protection elements described so far will detect the high and extremely damaging currents that will flow if this should happen. The scheme can easily be added to the 87S relay by bringing in three-phase current from the bypass breaker.

This element is designated 32CC [7]. If the circulating current element picks up, it will trip only the load-side circuit breaker to break the parallel path, yet leave the line in service on the bypass circuit breaker.

The phase currents are measured in the load side of the PST and the bypass circuit breaker. From these measurements, an additive and a subtractive current are calculated. The additive current represents the load current down the line. The subtractive current is a measurement of the circulating current in the bypass loop. The ratio of subtractive current to additive current indicates if circulating current is present.

- For even distribution of load current between the parallel branches, the ratio is 0.
- For the extreme of no load current in one of the branches, the ratio is 1.
- The only way for the ratio to be greater than 1 is if circulating current is present.

The tripping ratio is set at 1.1. The ratio check is supervised by requiring that the phase currents in each branch must be above a minimum pickup level. The minimum pickup level is set at 0.1 per unit of transformer capacity. Each of the three phase currents is measured separately to provide for the case where only one phase of the tap changer mechanism is stuck to cause the off neutral bypass situation.

B. Sequence Component PST Differential Element Setting Guidelines

The sequence component PST differential protection system has an adaptive slope characteristic. The sensitive slope has to be set to accommodate normal mismatch caused by various errors in the measurements [9]. The secure slope has to be set to accommodate maximum error when the PST is at maximum advance or retard and the angle compensation factor is not valid.

1) Tap Settings

The tap compensation factors are set using (2).

2) Sensitive Slope 1 Setting

The sensitive slope (Slope 1) needs to be set to accommodate the following normal steady-state and proportional errors:

- Voltage transformation error if PST is not symmetrical or can be operated not symmetrically.
- Error from PST step being two steps off the angle compensation factor. This error accommodates the lag between the tap changer taking a step and the smoothing filter of the angle compensation factor catching up, with a margin of one additional step.
- Excitation current (2 to 4 percent).
- CT error while in the linear range (0 to 3 percent).
- Relay accuracy error (5 percent).

These errors are summed up and used in (8) to calculate the minimum Slope 1 setting [9].

$$SLP1_{\text{MIN}}\% = \left(\frac{\text{Err}\%}{(200 - \text{Err}\%) \cdot k} \right) \cdot 100 \quad (8)$$

where:

$SLP1_{\text{MIN}}$ is the slope ratio that will just accommodate Err with no margin.

Err is the amount of error expected in normal operation.

k is the AVERAGE restraint scaling factor—0.5 in this case.

3) IRS1 Setting

The IRS1 setting is the breakpoint that limits the sensitive slope element to operate only at low multiples of tap. The sensitive element is there to provide for partial winding faults. At high currents where the error current may be higher, the secure slope setting provides more security. A setting of 2 to 3 per unit is appropriate.

4) Secure Slope 2 Setting

The secure slope (Slope 2) has to be set to accommodate mismatch caused by not having a valid angle compensation factor. This element will be in service and providing protection upon initial energization and loading of the PST if it is not on neutral until the electrical angle measurements of V1 and I1 are validated and the angle compensation factor reaches a suitable value. The error from operating at max δ

without angle compensation is obtained by simple trigonometric analysis of the uncompensated operate current when the PST is at maximum advance or retard angle.

The secure slope setting is also relied upon to provide security from false differential current caused by CT saturation. The worst-case PST angle error calculation will likely provide adequate slope for this purpose as well.

5) Delay Setting

The delay setting for the 87-1 and 87-2 elements must be set to accommodate the filter transient of the relay. A setting of 1.00 to 1.25 cycles is appropriate.

6) A2 Ratio Setting

The A2 = I2/I1 ratio setting is used to prevent operation of the 87-2 negative-sequence differential element for a balanced through fault where there may be a false negative-sequence current due to CT saturation. A setting of 10 percent is appropriate. Setting this supervisory element too high will result in some loss of sensitivity of the negative-sequence element for high load flow conditions.

7) Smoothing Filter Constant Setting

The angle compensation factor smoothing filter constant determines the time it takes for the reading to reach 95 percent of its new value after a step change. At 8 processing intervals per cycle, a smoothing filter constant of 0.99 yields a time constant equal to approximately 38 cycles. Setting the smoothing filter constant to 0.995 yields a time constant equal to approximately 75 cycles. The smoothing filter should allow the angle compensation factor to reach the new value after a tap change before the next tap change occurs.

C. Directional Overcurrent Element Setting Guidelines

The directional overcurrent elements in the PST relay are used for external fault detectors and for a supplementary directional 67P and 67Q POTT scheme.

1) External Fault/POTT Scheme Blocking Element Setting

The external fault detectors are set based on conservative assumptions unless information is available regarding the knee-point characteristics of the series winding core of the transformer. We start by assuming that the core is designed to withstand 10 percent overexcitation. We calculate the voltage rating of the series winding using trigonometric analysis. Fig. 11 shows the relationship of the regulating winding voltage to the transformer voltage rating and the maximum phase shift, δ . Use (9) to calculate V_{REG} .

$$V_{\text{REG}} = \frac{V_{\text{LL}}}{\sqrt{3}} \cdot 2 \cdot \text{SIN} \left(\frac{\delta_{\text{MAX}}}{2} \right) \quad (9)$$

where:

V_{REG} is the voltage rating of the regulating winding.

V_{LL} is the nominal V_{LL} of the PST.

δ_{MAX} is the maximum phase shift of the PST.

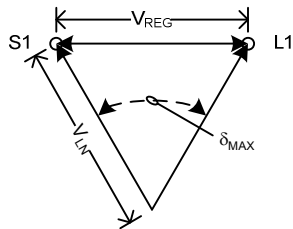

Fig. 11. Determining V_{REG}

We calculate the current that will cause a 10 percent voltage drop across the regulating winding using (10).

$$I_{SAT} = \frac{V_{REG} \cdot 10\%}{X_{REG}} \quad (10)$$

where:

I_{SAT} is the current that will cause a 10 percent voltage drop across the regulating winding.

V_{REG} is the voltage rating of the regulating winding.

X_{REG} is the leakage reactance of the PST at maximum tap.

We set the reverse directional phase overcurrent elements on the source- and load-side terminals of the zone to less than I_{SAT} using a 50 to 67 percent margin. We also use a 67Q (3I2) element set to the same pickup value for unbalanced faults. Per Fig. 9, this will block the sensitive differential elements for an external fault but leave the secure differential elements in service.

2) POTT Scheme Tripping Element Setting

The forward directional overcurrent elements on the source- and load-side terminals of the PST zone are used in a POTT scheme to supplement the sequence component differential elements for high-grade faults. Each element should be set based upon end-zone (opposite terminal internal) fault current under $N - 1$ source condition for the terminal in question. As with any POTT scheme, care should be taken to ensure that the forward POTT tripping elements are set above the reverse POTT blocking elements with a margin of 150 to 200 percent. The forward tripping elements should also be set above the expected inrush current.

3) Directional Element Settings

The directional elements require settings based upon expected minimum negative-sequence/positive-sequence and zero-sequence source impedance values. The typical method for setting these elements is based upon the impedance of the power system branch circuit directly in front of the directional element. However, this method is not reliable when the branch circuit to be protected is a PST. The impedance of the PST can vary widely, depending upon the tap position. This is especially true of single-core PSTs, which have zero leakage impedance when on neutral.

Reference [10] provides an alternative method for selecting directional element thresholds, where the thresholds are set to $\pm 0.3 \Omega$ secondary for nonlinear protection applications such as this. The minimum source impedances for both forward and reverse faults for both source and load terminals (four fault locations) must be checked to make sure that they are above these thresholds with margin.

D. Kirchhoff's Current Law Differential Element Setting Guidelines

The 87P, Kirchhoff's current law differential elements generally do not require extremely sensitive settings. For single-core PSTs, the fault currents that these elements will respond to are only limited by the impedance of the windings. For two-core PSTs, faults deep in the primary of the excitation winding are the boundary condition. A sensitive setting is not required for winding-to-ground faults near the neutral because the neutral-end CTs will directly measure the current in the fault loop. A sensitive setting may be desirable for phase-to-phase faults deep in the primary excitation winding where the currents are limited by the impedance of the windings. Generally, this protection is included to provide high-speed clearing of significant short circuits inside the PST. Low-level faults are covered by the sensitive sequence component differential elements and the 63SPR.

A typical setting for minimum pickup would be based on a phase-to-phase or phase-to-ground internal fault on the weakest terminal of the PST at maximum phase shift (maximum through impedance) under $N - 1$ source conditions with a 50 percent margin, or 1.0 to 1.2 per unit of the PST rating, whichever is lowest. The default slope settings of the relay are usually acceptable.

The subcycle bus type of relays recommended for this application do not include harmonic restraint or harmonic blocking features because these zones are not subject to magnetic core effects. However, there have been instances where harmonic blocking or restraint has been used to prevent misoperation on the spurious currents caused by proximity effects on poorly shielded CTs inside the tank of the PST. While the severity of proximity effects is difficult to predict, if the 87P relay differential elements are set per the above guidelines, they will be less susceptible to this phenomenon.

VII. CONCLUSION

PSTs are useful for maximizing the utilization of available transmission line assets by allowing precise control of power flows on lines. PSTs are typically constructed in three different configurations. The main consideration for protection is whether the PST is of single-core design or two-core design.

In the past, protection recommendations for single-core PSTs did not attempt to provide AT balance differential protection that could detect turn-to-turn faults. This was because the operation of the tap changer on the regulating winding results in an AT unbalance that ranges from 0 to 100 percent. It simply was not possible to accommodate this range of unbalance with conventional differential relays. This deficiency in protection is especially of concern for single-core PSTs because the tap changer and tap leads are directly in the series circuit between the source- and load-side bushings.

Protection for two-core PSTs also failed to provide AT balance differential protection for the excitation core windings of the PST.

Kirchhoff's current law differential protection is applied to PSTs. However, this protection requires CTs to be buried inside the tank of the PST. Locating CTs inside the tank can

complicate the insulation system of the PST and potentially reduce the reliability of the PST itself. Further, locating CTs inside the tank makes them vulnerable to proximity effects that can cause relay misoperation if the CTs are not properly shielded.

A sequence component PST differential protection system is now available that relies only on CTs in the source- and load-side bushings or boundaries to the differential zone. This new system provides protection for all types of faults, including turn-to-turn faults. The original protection system has been in service for many years on more than 10 single-core PSTs with a perfect operating history. There have been no security failures and no dependability failures while in service.

A new relay platform is now available that can implement the sequence component differential PST protection system in a single relay—greatly simplifying system design, performance, and economics. The new system is capable of compensating for the variable phase shift across the PST using electrical measurements of V1 angle and I1 angle across the PST. This eliminates the complexity of obtaining a reliable mechanical indication of tap changer position into the relay for phase shift compensation. Using electrical measurements instead of mechanical measurements of the phase shift improves the applicability of the protection system to more PSTs and improves security of the system from misoperation.

Recommendations are provided for designing and setting a comprehensive and redundant protection system for all common types of PSTs. The combination of 87P, Kirchhoff's current law differential, and 87S, sequence component differential, as recommended in this paper, provides optimum protection. The 87P relay provides subcycle detection of serious short circuits where high sensitivity is not required. The 87S relay provides high sensitivity for turn-to-turn faults where high speed is not required.

When the 63SPR relay(s) are paired with the 87P relay, tripping through a primary lockout relay, a Main 1 system is created. With the combination of the POTT system, the AT balance differential (two-core PSTs), and the sequence component differential in the 87S relay, tripping through a secondary lockout relay, a Main 2 system is created. The two systems are complementary and provide both high speed for significant faults and sensitivity for turn-to-turn faults. Alternatively, many PST owners choose to use two sets of 87P and 87S systems for complete redundancy.

The new developments presented here revolutionize the protection of PSTs. Protection is improved in the following ways:

- Simplicity by providing an elegant solution for balancing AT turns on the regulating winding of a PST across the wide range of phase shifts inherent in a PST.
- Dependability by providing electrical detection of turn-to-turn faults.
- Security by eliminating the need to use mechanical compensation for the PST phase shift.

VIII. REFERENCES

- [1] D. A. Tziouvaras and D. Hou, "Out-of-Step Protection Fundamentals and Advancements," proceedings of the 30th Annual Western Protective Relay Conference, Spokane, WA, October 2003.
- [2] B. Kasztenny, M. Thompson, and N. Fischer, "Fundamentals of Short-Circuit Protection for Transformers," proceedings of the 63rd Annual Conference for Protective Relay Engineers, College Station, TX, March 2010.
- [3] IEEE Standard C57.135-2011, IEEE Guide for the Application, Specification, and Testing of Phase-Shifting Transformers, August 2011.
- [4] "Protection of Phase Angle Regulating Transformers: A Report to the Substation Subcommittee of the IEEE Power System Relaying Committee Prepared by Working Group K1," IEEE Special Publication, October 1999.
- [5] W. Seitlinger, "Phase Shifting Transformers Discussion of Specific Characteristics," Paper 12-306, CIGRE 1998.
- [6] D. A. Tziouvaras and R. Jimenez, "Protecting a 138 kV Phase Shifting Transformer: EMTF Modeling and Model Power System Testing," proceedings of the 29th Annual Western Protective Relay Conference, Spokane, WA, October 2002.
- [7] M. J. Thompson, H. Miller, and J. Burger, "AEP Experience With Protection of Three Delta/Hex Phase Angle Regulating Transformers," proceedings of the 33rd Annual Western Protective Relay Conference, Spokane, WA, October 2006.
- [8] M. J. Thompson, "Apparatus and Method for Providing Differential Protection for a Phase Angle Regulating Transformer in a Power System," U.S. Patent 7,319,576 B2, January 2008.
- [9] M. J. Thompson, "Percentage Restrained Differential, Percentage of What?" proceedings of the 37th Annual Western Protective Relay Conference, Spokane, WA, October 2010.
- [10] K. Zimmerman and D. Costello, "Fundamentals and Improvements for Directional Relays," proceedings of the 63rd Annual Conference for Protective Relay Engineers, College Station, TX, March 2010.

IX. BIOGRAPHY

Michael J. Thompson received his BS, magna cum laude, from Bradley University in 1981 and an MBA from Eastern Illinois University in 1991. He has broad experience in the field of power system operations and protection. Upon graduating, he served nearly 15 years at Central Illinois Public Service (now AMEREN), where he worked in distribution and substation field engineering before taking over responsibility for system protection engineering. Prior to joining Schweitzer Engineering Laboratories, Inc. (SEL) in 2001, he was involved in the development of several numerical protective relays while working at Basler Electric. He is presently a principal engineer in the engineering services division at SEL, a senior member of IEEE, a main committee member of the IEEE PES Power System Relaying Committee, and a registered professional engineer. Michael was a contributor to the reference book *Modern Solutions for the Protection, Control, and Monitoring of Electric Power Systems*, has published numerous technical papers, and has a number of patents associated with power system protection and control.