

**DISTANCE PROTECTION OF SERIES COMPENSATED LINES –
PROBLEMS AND SOLUTIONS**

Bogdan Kasztenny

Bogdan.Kasztenny@IndSys.GE.com

(905) 201 2199

GE Power Management
215 Anderson Avenue
Markham, Ontario
Canada L6E 1B3

1. Introduction

Increased transmittable power, improved system stability, reduced transmission losses, enhanced voltage control and more flexible power flow control are technical reasons behind installing Series Capacitors (SCs) on long transmission lines. Environmental concerns and direct cost benefits stand for that too.

SCs and their overvoltage protection devices (typically Metal Oxide Varistors, MOVs and/or air gaps), when installed on a transmission line, create, however, several problems for its protective relays and fault locators. Operating conditions for protective relays become unfavorable and include such phenomena as voltage and/or current inversion, sub-harmonic oscillations, and additional transients caused by the air gaps triggered by thermal protection of the MOVs. Overreaching of distance elements due to series compensation is probably the most critical and known consequence of SCs. The opposite may happen as well: a distance function may fail to pick up a low-current fault on the protected line.

This paper focuses on several phenomena specific to series compensated lines. Insights of these singularities help to understand limitations of distance relays put in operation on series compensated lines and to apply the relays more efficiently.

The analysis part of the paper starts with Section 2 where the equivalent phase and symmetrical impedances of the SCs and MOVs are examined. The problem of a zero-sequence compensating factor is addressed as well.

Section 3 analyses a low-current single-line-to-ground (SLG) fault in a sample series compensated system. The phenomena of voltage and current inversions are explained and illustrated using this sample system. Consequences of several combinations of inversion of various signals on typical distance comparators are presented. The signals include phase, positive-, negative- and zero-sequence voltages and currents. The comparators analyzed are memory-polarized mho, zero-sequence polarized reactance, memory-polarized negative- and zero-sequence directional.

Section 4 addresses transients associated with series compensation.

Section 5 presents a solution that ensures directional integrity of protection on series compensated lines and in a vicinity of series compensated lines: an offset impedance for negative- and zero-sequence directional elements. Setting calculation rules for the offset impedance are provided.

Section 6 presents a concept of a current-controlled adaptive reach for distance protection as a solution to an overreaching problem.

Section 7 discusses phase selection problems for single-pole tripping on series compensated lines.

Section 8 focuses on fault location in series compensated lines.

2. Series Capacitors and MOVs – Equivalent Impedance

Vast majority of microprocessor-based distance relays respond to more (security) or less (speed) accurately filtered fundamental frequency components. Therefore, it becomes important to understand relations between the fundamental frequency voltage and current of a typical arrangement of SCs and their overvoltage protection devices.

Three single-phase banks of capacitors are used for series compensation. Each capacitor must be protected against overvoltages by air gaps or Metal Oxide Varistors (MOVs) or both. Under load conditions or low-current faults, the voltage drop across the SCs is below the voltage protection level: neither the air gaps nor the MOVs conduct any current. Therefore, the SC bank is equivalent to a pure reactance equal the reactance of the actual (physical) capacitor. Under very high current faults the voltage drop would be far above the protection level: the gaps and/or MOVs conduct majority of the through current, practically by-passing the SCs. Therefore, for large through currents the SC bank is equivalent to a small resistance.

Between the two extremes there are situations when a comparable amount of current flows through the SCs and the MOVs. Fig.1 illustrates such a case. As the through current becomes larger, the voltage drop across the bank (Fig.1a) assumes more rectangular shape, being limited to the voltage protection level. The capacitors conduct the current during initial half-cycles (Fig.1b), while the MOVs conduct during the remaining halves (Fig.1c). The through current being a sum of the two is not distorted as compared with its two contributors, and is shifted in a leading direction with respect to the voltage drop across the bank. Relation between the fundamental frequency components of the voltage drop across the bank and the through current is a resistive-capacitive impedance known as a Goldsworthy's equivalent [1].

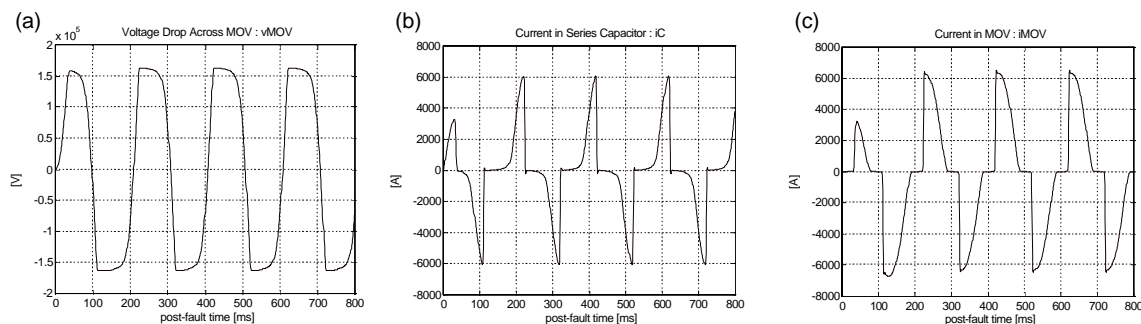

Figure 1. Voltage drop across a series capacitor with a conducting MOV (a); capacitor (b) and MOV (c) currents, respectively.

2.1. Equivalent Phase Impedance

Consider a parallel arrangement of an ideal capacitor (SC) and a non-linear resistor (MOV) shown in Fig.2a. Approximation of the MOV characteristic – accurate enough for protective relaying analysis – is given by the following equation:

$$i = P \cdot \left(\frac{v}{V_{REF}} \right)^q \quad (1)$$

where P and V_{REF} are coordinates of the knee-point and q is an exponent of the characteristic (Fig.2c shows a sample MOV characteristic).

For any operating condition of the parallel connection of Fig.2a one may calculate analytically, simulate using a transient program, or measure the fundamental components of the voltage across the bank and the through current. The ratio of such voltage and current phasors is an equivalent impedance (Fig.2b). It is obvious that the equivalent resistance and reactance are dependent on the through current (Fig.2d). For currents producing the voltage drop below the voltage protection level (2.4kA in this example), the resistance is zero and the reactance equals the actual reactance of the SC (65 ohms in this example). For higher currents (3-4kA in this example) the resistance increases while the reactance consistently decreases. For very high currents, the reactance approaches zero so does the resistance.

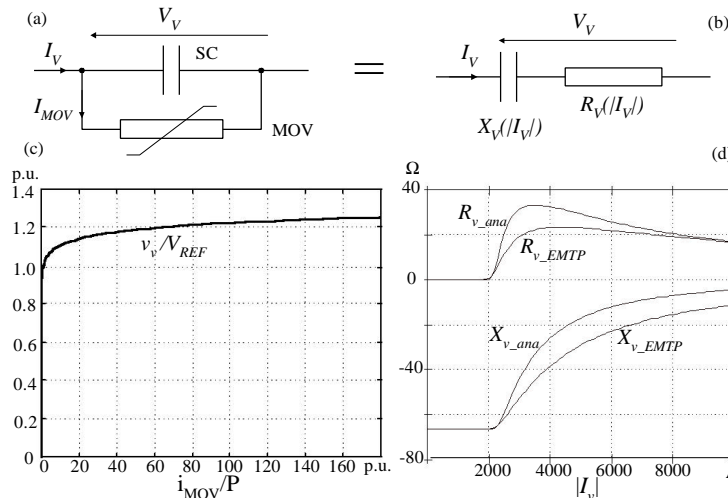

Figure 2. Series capacitors with MOVs (a); equivalent fundamental frequency impedance (b); sample MOV characteristic (c); sample current-dependent parameters of the equivalent impedance.

Fig.2d presents the equivalent resistance and reactance derived using two methods:

First, the EMTP simulations in a sample system have been performed and the voltage and current waveforms with their natural distortions have been recorded. Second, the Fourier Transform has been used to calculate the phasors and derive the impedance. The procedure has been repeated for various levels of the through current, resulting in a characteristic.

Second, a sinusoidal voltage drop has been assumed, while the through current, and subsequently the impedance has been calculated analytically.

The differences visible in Fig.2d result from various assumptions to calculating the Goldsworthy's model. Generally, the EMTP-type equivalent is more adequate for protective relaying studies, particularly if the phasors were derived using the actual filtering techniques used by a protective relay under consideration.

The concept of an equivalent impedance allows grasping the basics of the distance overreaching phenomenon. If the SCs are located between the fault and the relay potential point, the fault loop contains the line-to-fault impedance, fault resistance (if any) and the equivalent SC&MOV impedance. The latter being resistive-capacitive shifts the apparent impedance down and to the right as shown in Fig.3.

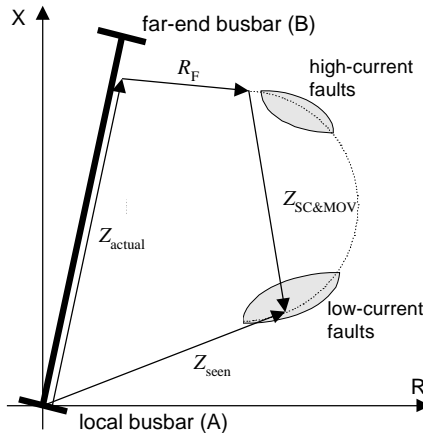

Figure 3. Distance element overreaching due to series compensation.

Overreach is the primary consequence of the situation depicted in Fig.3. In the worst case – for low-current faults – the equivalent SC&MOV impedance is a pure reactance shifting the apparent impedance down by the entire reactance of the physical capacitors. As the lines are typically compensated at the 50-70% rate, the overreach may be as high as 50-70%. For high-current faults, though, the equivalent SC&MOV impedance shifts the apparent impedance only slightly to the right. There is no danger of overreaching. This observation leads to a concept of a current-controlled adaptive reach described in Section 6.

During medium-current faults on the line, the apparent impedance may be shifted to the right by more than half the reactance of the capacitors. This relocation may be high enough to push the apparent impedance outside the operating characteristic, particularly if a lens, conservatively set blinders, or load encroachment characteristics are used.

Another observation that can be derived from this simplified model is a failure of a distance function to respond to a low-current close-in fault. Under such a fault, the apparent impedance moves to the fourth quadrant of the impedance plane resulting in problems with directional discrimination.

The SC&MOV bank acts as a “fault current stabilizer”: for larger currents the capacitive reactance is smaller while the resistance is larger – this reduces the current as compared with a fully compensated circuit; for smaller currents the capacitive reactance is larger – this reduces the net impedance and increases the current as compared with a non-compensated circuit. As a result, the fault current versus fault location characteristic is flatter for series-compensated lines comparing with non-compensated lines.

The Goldsworthy’s model is useful in understanding some phenomena, but its practical applications – other than fault studies using numerical packages – are very difficult.

First, the equivalent resistance and reactance are non-linear functions of the through current. This non-linearity makes all the analytical calculations practically impossible.

Second, the through current depends on a number of factors such as system conditions, fault location, fault type and fault resistance.

Third, both traditional power system analysis and principles of protective relaying are based on sequence networks and symmetrical components rather than phase components and physical three-phase networks. For example, the reactance characteristic is typically polarized from the zero-sequence or negative-sequence currents for increased security on heavily loaded lines. The impact of series compensation on the angle of such polarizing signal is equally important as the impact on the phase current or voltage.

For practical outcome the sequence networks of the SC bank must be analyzed taking into account both asymmetries: the parallel asymmetry caused by a fault must be considered together with the series asymmetry caused by various operating conditions of the SCs and MOVs in particular phases of the three-phase compensating bank. The next subsection addresses this issue in more detail.

2.2. Equivalent Sequence Impedances

In general, voltage drops across a linear three-phase element are proportional to through currents. The proportionality factor is called an impedance. For three-phase systems this could be written in a compact matrix form as follows:

$$\begin{bmatrix} V_A \\ V_B \\ V_C \end{bmatrix} = \begin{bmatrix} Z_{AA} & Z_{AB} & Z_{AC} \\ Z_{BA} & Z_{BB} & Z_{BC} \\ Z_{CA} & Z_{CB} & Z_{CC} \end{bmatrix} \cdot \begin{bmatrix} I_A \\ I_B \\ I_C \end{bmatrix} \quad (2)$$

Or for the symmetrical components:

$$\begin{bmatrix} V_0 \\ V_1 \\ V_2 \end{bmatrix} = \begin{bmatrix} Z_{00} & Z_{01} & Z_{02} \\ Z_{10} & Z_{11} & Z_{12} \\ Z_{20} & Z_{21} & Z_{22} \end{bmatrix} \cdot \begin{bmatrix} I_0 \\ I_1 \\ I_2 \end{bmatrix} \quad (3)$$

Under normal circumstances, the equivalent Z_{012} impedance matrix becomes diagonal. This means that there is no mutual coupling between the symmetrical components or sequence networks:

$$\begin{bmatrix} V_0 \\ V_1 \\ V_2 \end{bmatrix} = \begin{bmatrix} Z_0 & 0 & 0 \\ 0 & Z_1 & 0 \\ 0 & 0 & Z_2 \end{bmatrix} \cdot \begin{bmatrix} I_0 \\ I_1 \\ I_2 \end{bmatrix} \quad (4)$$

The resulting decoupling of the sequence networks is the prime enabler for the traditional short circuit calculations.

This is not, however, the case for SC and MOVs: the phase impedances are not coupled, while the sequence impedances may get coupled if the series asymmetry occurs, i.e. if the Goldsworthy's impedances differ between the phases.

The following applies for the banks of three SCs and MOVs:

$$\begin{bmatrix} V_A \\ V_B \\ V_C \end{bmatrix} = \begin{bmatrix} Z_A & 0 & 0 \\ 0 & Z_B & 0 \\ 0 & 0 & Z_C \end{bmatrix} \cdot \begin{bmatrix} I_A \\ I_B \\ I_C \end{bmatrix} \quad (5)$$

where Z_A is a Goldsworthy's equivalent for phase A (dependent on the magnitude of the phase A current), Z_B is an equivalent for phase B, and Z_C is an equivalent for phase C.

Talking into account the relations between the phase and symmetrical currents and voltages, the following Z_{012} impedance matrix is calculated from equation (5) for the three banks of SCs and MOVs:

$$Z_{012} = \frac{1}{3} \begin{bmatrix} Z_A + Z_B + Z_C & Z_A + a^2 Z_B + a Z_C & Z_A + a Z_B + a^2 Z_C \\ Z_A + a Z_B + a^2 Z_C & Z_A + Z_B + Z_C & Z_A + a^2 Z_B + a Z_C \\ Z_A + a^2 Z_B + a Z_C & Z_A + a Z_B + a^2 Z_C & Z_A + Z_B + Z_C \end{bmatrix} \quad (6)$$

where a is a 120deg shift operator as per theory of symmetrical components.

In general, the three impedances A, B and C are different. This results in the off-diagonal elements of the matrix (6). Electrically, it means that there are mutual couplings between the sequence networks representing the SC bank: the positive sequence voltage depends on the negative- and zero-sequence currents, for example.

Let us consider only the extreme cases of either very high or very low currents for various fault types.

Low-current faults and load conditions (none of the MOVs conduct)

$$Z_A = Z_B = Z_C = -jX_{SC} \quad (7a)$$

Using (6) one calculates:

$$Z_{012} = \begin{bmatrix} -jX_{SC} & 0 & 0 \\ 0 & -jX_{SC} & 0 \\ 0 & 0 & -jX_{SC} \end{bmatrix} \quad (7b)$$

For this case equation (7b) means that there is no mutual coupling between the sequence networks. The zero-, positive- and negative-sequence impedances of the SC bank equal the physical reactance of the capacitors.

High-current SLG faults (phase A MOV conducts all the current)

$$Z_A = 0, \quad Z_B = Z_C = -jX_{SC} \quad (8a)$$

Using (6) one calculates:

$$Z_{012} = \frac{1}{3} \begin{bmatrix} -2jX_{SC} & jX_{SC} & jX_{SC} \\ jX_{SC} & -2jX_{SC} & jX_{SC} \\ jX_{SC} & jX_{SC} & -2jX_{SC} \end{bmatrix} \quad (8b)$$

For this case equation (8b) means that there is a mutual coupling between the sequence networks. The self impedances (00,11,22) are capacitive and equal $2/3^{\text{rd}}$ of the physical reactance of the capacitors. The mutual impedances (01,02,12) are inductive and equal $1/3^{\text{rd}}$ of the capacitor reactance. The latter fact means for example that the positive-sequence current causes a leading voltage drop for the zero-sequence voltage.

High-current LL and LLG faults (phase A and B MOVs conduct all the current)

$$Z_A = Z_B = 0, \quad Z_C = -jX_{SC} \quad (9a)$$

Using (6) one calculates:

$$Z_{012} = \frac{1}{3} \begin{bmatrix} -jX_{SC} & -jX_{SC} & -jX_{SC} \\ -jX_{SC} & -jX_{SC} & -jX_{SC} \\ -jX_{SC} & -jX_{SC} & -jX_{SC} \end{bmatrix} \quad (9b)$$

For this case equation (9b) means that there is a mutual coupling between the sequence networks due to the series asymmetry.

Equations (6) through (9) flag a complex condition: mathematically the impedance matrices are not diagonal, or electrically there are mutual couplings between the sequence networks. The situation, however, is not that complex when considering the following:

First, for high-current SLG fault, the faulted phase SC is by-passed and the voltage drop across that phase is small as compared with the voltage drop across the line. The voltage drops in the two healthy phases are small as well despite the series capacitors, because the currents in those phases are very small as compared with the current in the faulted phase. For fault at the far end busbar being a concern as far as the overreaching is considered, the voltage drops across the compensating bank in all three phases may be disregarded comparing with the voltage drops across the line (Fig.4a).

This means that the sequence impedances of the SC and MOVs (Z_0 , Z_1 and Z_2) may be assumed zero for the first approximation analysis of high-current SLG faults.

The same result is obtained using equation (8b) and assuming $I_1=I_2=I_0$ (relation between the symmetrical currents for a SLG fault).

Second, the LL and LLG faults are very unlikely to be high-resistance faults. It is justified to assume that the SC will be effectively by-passed in the faulted phases. The healthy phase will conduct much lower current. Consequently, the voltage drops in the faulted phases will be small as compared with the voltage drop along the line because of the low Goldsworthy's equivalent impedance in those phases. The voltage drop in the healthy phase is low as well despite the SC being in place because the current in that phase is low.

Similarly to the previous case (Fig.4b) the sequence impedances of the SC and MOVs (Z_0 , Z_1 and Z_2) may be assumed zero for the first approximation analysis of high-current LL, LLG and 3P faults.

The same result is obtained using equation (9b) and assuming $I_1=-I_2$.

Third, the low-current faults may happen either in very weak systems (large equivalent impedance of the systems) and/or during high-resistance faults. The first alternative does not impose much danger on protective relaying, as the series capacitors will be small compared to inductive system reactances. The effective compensation level will be small and the major problems associated with series compensation will not occur. The second alternative calls for a high fault resistance. Practically, however, high fault resistance could be encountered only for SLG faults.

Summarizing: for all the high-current faults it is justified to neglect all three banks of SCs and MOVs regardless of the fault type. For lower current levels the effective series reactance is smaller as compared with the reactance of the physical capacitors. The entire physical reactance (the one causing the maximum overreach) shall be considered only for high-resistance SLG faults. Under the latter condition, however, the analysis is simple as the symmetrical networks are decoupled and $Z_0=Z_1=Z_2=-jX_{SC}$.

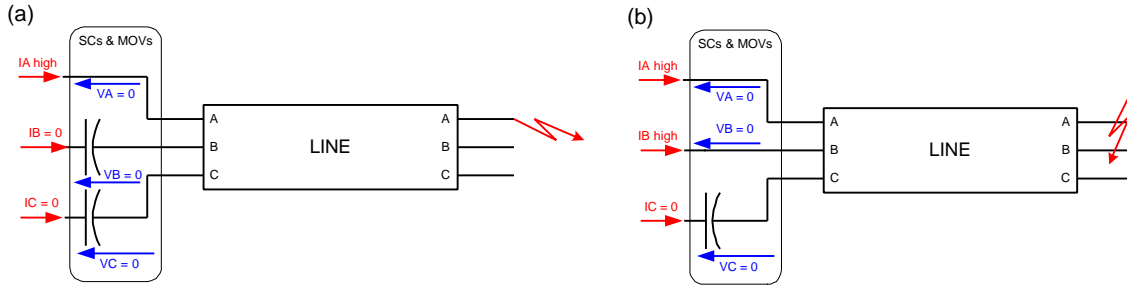

Figure 4. Voltage drops across the SC banks during high-current faults: SLG faults (a) and LL/LLG faults (b).

2.3. Zero-Sequence Compensating Factor

The zero-sequence compensating factor as a setting may be defined differently by various vendors, but as per principle of ground distance relaying the proper compensation (accounting for the difference between the positive- and zero-sequence impedances) calls for the following operation:

$$\text{Current for the 21G function, phase A: } I_{AG} = I_A + \frac{1}{3}(I_A + I_B + I_C) \cdot \left(\frac{Z_0 - Z_1}{Z_1} \right) \quad (10)$$

The $(Z_0 - Z_1)/Z_1$ is a complex number and depends on the ratio between the zero- and positive-sequence impedances from the potential point of the relay to the fault. Normally, the protected circuits are homogenous or only slightly non-homogenous: the Z_0/Z_1 ratio is constant along the line or changes only slightly depending on the fault position. Typically, distance relays provide for a separate K0 setting for the first ground zone and all the remaining zones.

In the case of series compensated lines, if the series capacitors are between the fault and the potential point of the relay, the Z_0/Z_1 ratio may be drastically affected by the fault position and fault current level.

In general, for medium current faults, when the Goldsworthy's equivalent impedances are neither zeros nor pure reactances, mutual coupling between the sequence voltages and currents occurs, and the principle of traditional ground distance protection is violated. In

other words, the accurate loop current for phase A of ground protection is not given by the classical equation (10). The apparent positive sequence impedance still can be – at least theoretically – calculated by the relay but the equations become non-linear and impractical. Some fault location algorithms for series compensated lines, such as the algorithm [2], take into account the current-dependent Goldsworthy's parameters. For distance relaying, however, the approach is not practical.

Majority of the protection engineers would probably use the Z_0/Z_1 data of a plain line, or the “K0” factor calculated by a short-circuit program for a fault at the intended reach point. The latter may or may not include the series capacitors. If included, the capacitors are treated as for low-current faults, i.e. $Z_A=Z_B=Z_C=Z_0=Z_1=Z_2=-jX_{SC}$.

Consider a low-current SLG fault. The accurate Z_0/Z_1 ratio shall reflect the impedances from the potential point to the fault. For example, if the SCs are located in the substation, the VTs are on the bus side of the SCs, and the fault location is a from the substation with the SCs, the following applies:

$$\frac{Z_0 - Z_1}{Z_1} = \frac{a \cdot Z_{0LINE} - jX_{SC}}{a \cdot Z_{1LINE} - jX_{SC}} - 1 \quad (11)$$

Surprisingly, the accurate value of the zero-sequence compensation setting would depend on the fault location. None of the available relays provide for such as a feature. Due to other factors limiting the reach accuracy of the ground distance protection, dependency like the one given by equation (11) is not considered practical.

Fig.5 presents a plot of the $(Z_0-Z_1)/Z_1$ number for the case given by equation (11). For faults just beyond SCs, the fault loop consists of the SCs alone. Because $Z_0=Z_1$ for the SCs under low-current faults, no compensation is required because $(Z_0-Z_1)/Z_1 = 0$. For faults further into the line, some compensation is required, but the sign of it is opposite to the one for uncompensated lines. For faults at about 70% (in this case), the Z_1 value is very small (the capacitive and inductive reactances cancel mutually, and Z_1 equals the circuit resistance), and consequently the $(Z_0-Z_1)/Z_1$ number is very large. As the fault moves away from the relaying point, the $(Z_0-Z_1)/Z_1$ number converges asymptotically on the line value.

In this example, when using the $(Z_0-Z_1)/Z_1$ as for the plain line, the relay would be compensated in a wrong direction (the accurate $(Z_0-Z_1)/Z_1$ number is negative – the angle is close to 180 degrees). The relay would be overcompensated for faults up to some 30%, and significantly undercompensated for faults close to 70% of the line length.

For plain lines it is quite straightforward to evaluate the consequences of over- and under-compensation: overcompensation increases the loop current, thus reduces the apparent impedance and causes overreach; undercompensation takes the opposite effect.

For series compensated lines, the consequences are not that straightforward as the relation between the sequence currents may be quite different due to signal inversions.

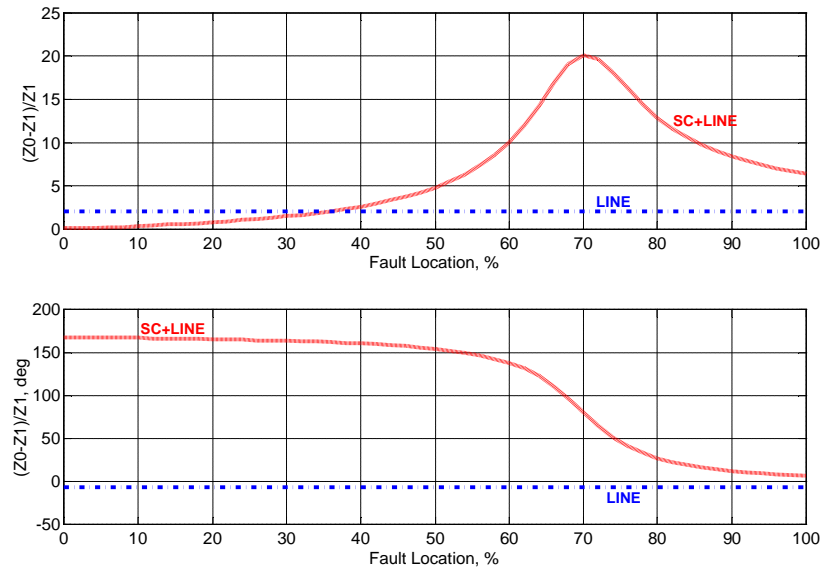

Figure 5. Zero-sequence compensating factor for a relay looking through SCs (bus potential source) at a low-current SLG fault as a function of fault location.

Consequently, the plain line zero-sequence compensating factor is probably a reasonable practical choice. The application of setting is limited anyway as the relays allow the user to enter a fixed number.

If there are no SCs between the intended reach and the relay potential point, the zero-sequence compensating factor is not affected. For external faults, however, the required compensating factors may be quite different as compared with the value for the protected line. Consequently, the practice to reduce the reach of ground distance elements (as compared with phase elements) is even more valid for series compensation applications.

3. Low-Current SLG faults

As indicated in the previous section, a low-current SLG fault is the type of situation that could cause real problems for distance protection of series compensated lines.

If the low-current fault results from weak systems, the capacitive reactances are cancelled with a very large margin by source inductive reactances and problems related to series compensation do not manifest themselves. A high-resistance fault in a relatively strong system is thus the event to consider.

This section analyzes in detail signals at the relaying points of a sample system. Subsequently, response of traditional distance comparators is studied for the same system. Although using a single system, this section illustrates in a practical way several particularities of distance applications on series compensated lines.

3.1. Protection Signals in a Sample System

Consider the system shown in Fig.6. In order to analyze faults on the protected line and its terminals, the system can be equivalenced as shown in Fig.7.

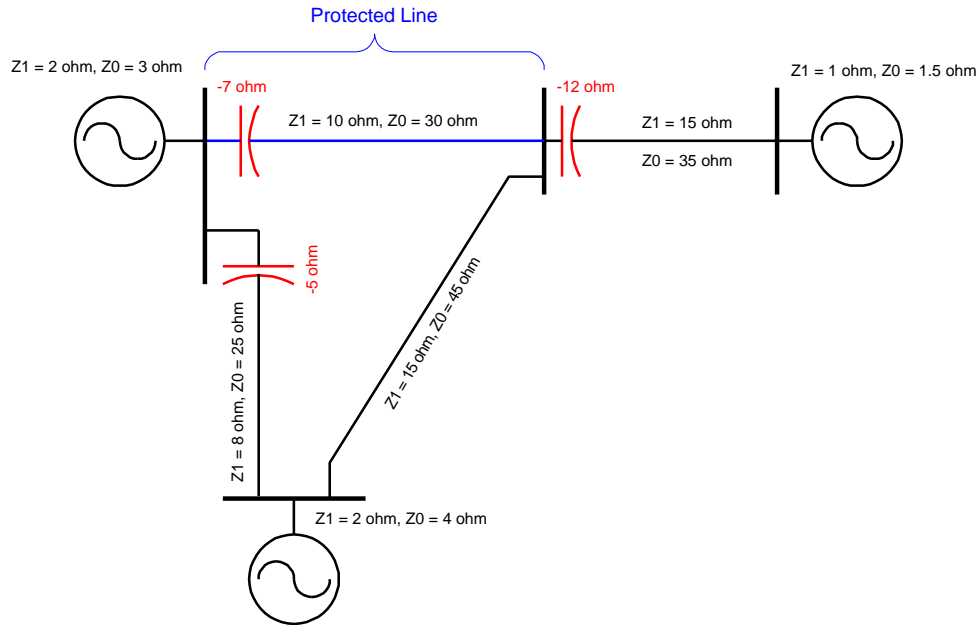

Figure 6. Sample system with series-compensated lines (secondary ohms).

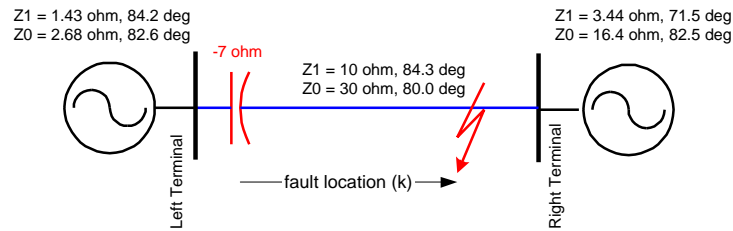

Figure 7. Equivalent of the sample system for internal faults.

Assume a SLG fault on the line at the distance k [pu] from the left terminal. As the fault is a low-current fault, the MOVs do not conduct, the sequence networks for the SCs are decoupled and the equivalent diagram for the short-circuit calculations is shown in Fig.8. All the signals of interest can be easily calculated from this network. In the following examples a 10-ohm (secondary) fault resistance is assumed.

Fig.9 shows the magnitude and phase angle (all phase angles referenced to the phase A pre-fault voltage at the left terminal). For faults closer than some 35% of the line, the fault current is capacitive. This results from the fact that the sum of the zero-, positive- and negative-sequence impedances seen from the fault point is capacitive. For a fault at some 35% of the line, the inductive and capacitive reactances cancel and the fault current is purely resistive limited only by the total resistance of the fault loop of Fig.8. Consequently, the fault current is maximal for this fault.

In a sense fault current “inversion” happens for faults closer than 35%. However, the term “inversion” is not precise: what happens in series compensated networks is rather an “unnatural” phase shift with respect to the “natural” position of a given phasor. A 180-degree “inversion” is practically never happens.

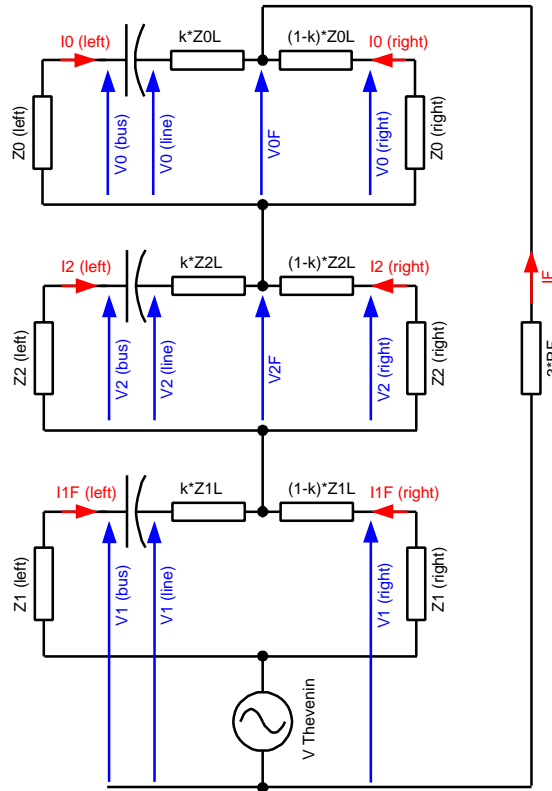

Figure 8. Sequence networks and symmetrical components for low-current SLG faults.

Fig.10 shows the currents in the faulted phase at the left and right terminals. Typically, the magnitude of the fault current decreases as the fault moves away from the terminal. In the case of Fig.10, the right terminal current reaches its minimum for a fault at about 55% from the right end of the line and starts increasing for more distant faults. What is also quite unusual is that the two currents are practically out of phase for faults close to the left terminal. Both the currents are unnaturally shifted: the left-terminal current is capacitive; the right-terminal current is practically resistive and out of phase with the phase A voltage.

This situation may cause potential problems to the phase comparison protection. The current differential relay shall still perform correctly, as the currents – although out of phase – differ significantly as to the magnitude. This would result is a large differential current and a trip.

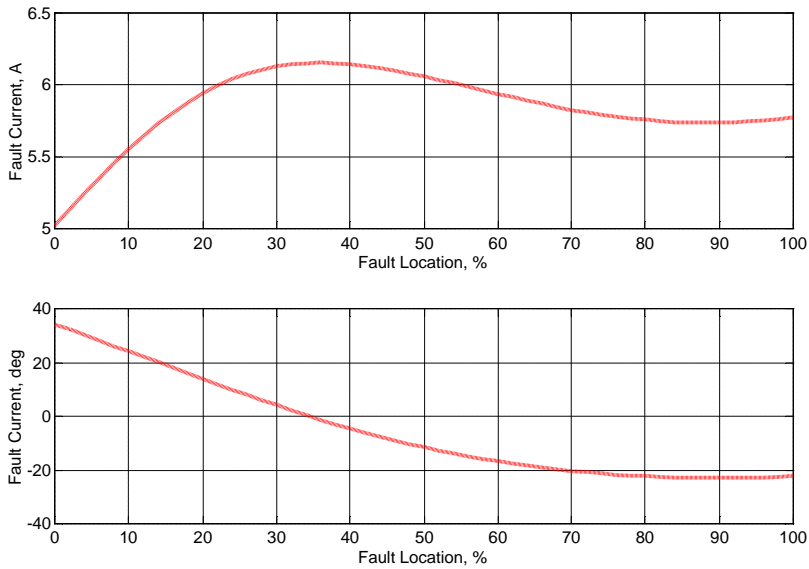

Figure 9. Fault current: magnitude (top) and phase angle (bottom).

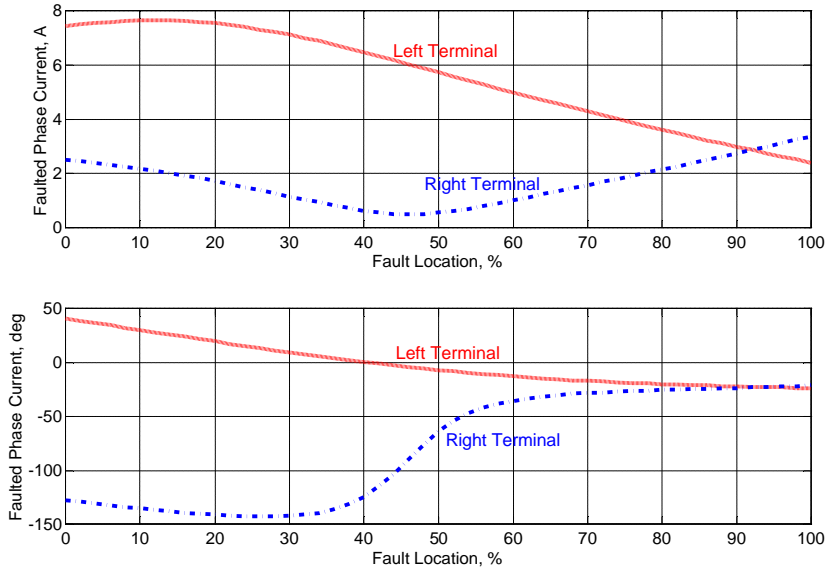

Figure 10. Faulted phase currents: magnitude (top) and phase angle (bottom).

Fig.11 presents the faulted phase voltages at the right and left (both bus-side and line-side VTs) terminals. For faults beyond some 25% of the line, the line-side voltage is significantly above the nominal value. This results from the fact that the inductive phase current is flowing through a capacitive impedance causing a voltage drop out of phase with the pre-fault voltage. The negative voltage drop subtracted from the bus voltage increases the voltage on the line side of the SCs above the pre-fault value. The bus-side voltage, in turn, rises above its nominal value for close in faults. This results from a capacitive phase current flowing through an inductive system impedance and causing a

voltage drop out of phase with the system electromotive force (e.m.f.). Subtracting the negative value from the latter results in an overvoltage condition on the bus side.

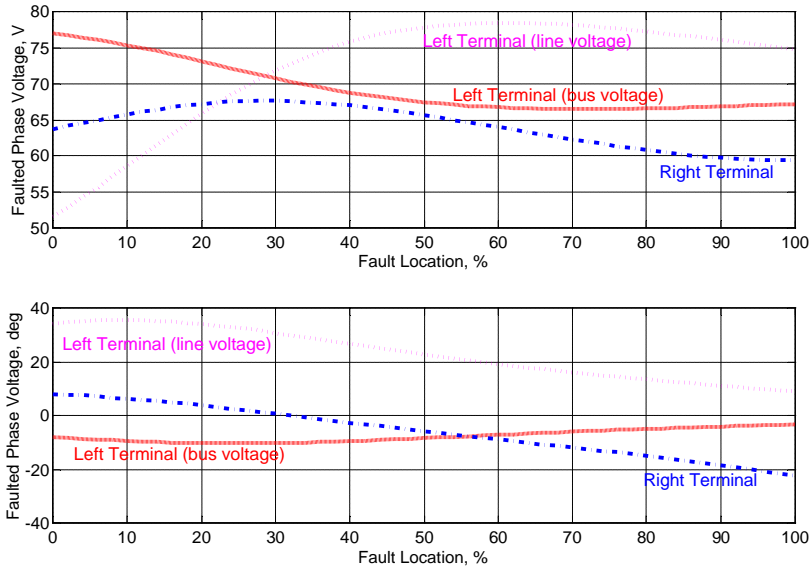

Figure 11. Faulted phase voltages: magnitude (top) and phase angle (bottom).

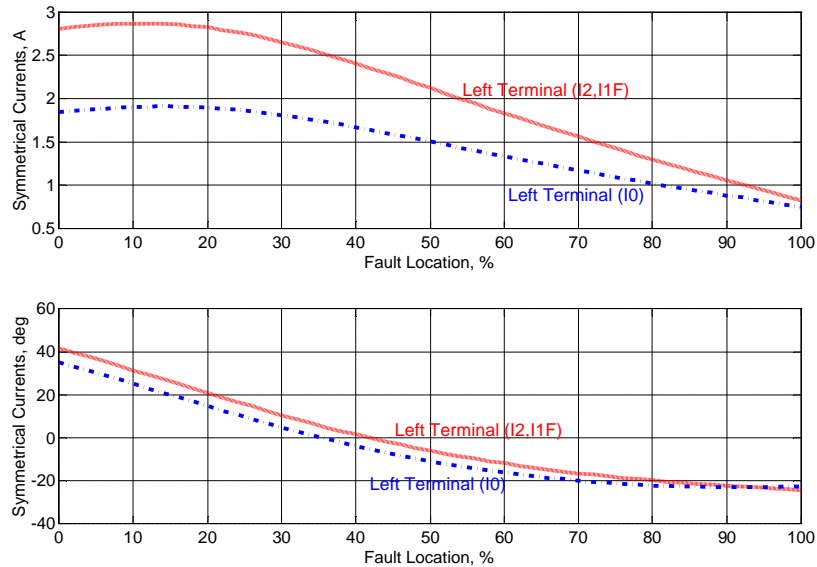

Figure 12. Symmetrical currents at the left terminal: magnitude (top) and phase angle (bottom).

Fig.12 presents symmetrical components of the current at the left terminal. Both negative- and zero-sequence currents are capacitive for faults within the 35-40% range. Due to differences between the zero- and negative-sequence impedances of the system, the switchover points for the two currents are different. This results in a spot between 35% and 40% of the line, where the zero-sequence at the left terminal current is inductive while the negative-sequence current is capacitive.

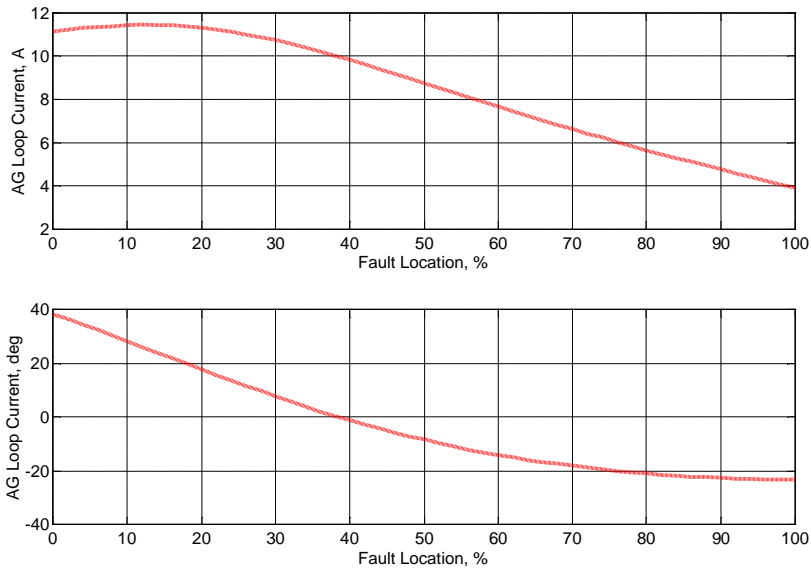

Figure 13. Fault loop current at the left terminal: magnitude (top) and phase angle (bottom).

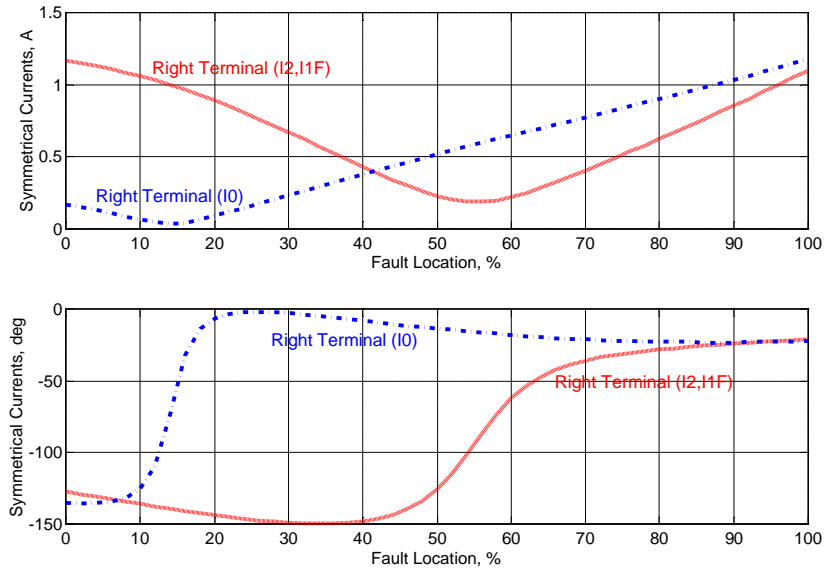

Figure 14. Symmetrical currents at the left terminal: magnitude (top) and phase angle (bottom).

Fig.13 shows a fault loop current (equation (10)) at the left terminal obtained using the zero-sequence compensation setting as for a plain line. The current is capacitive for faults closer than 40% of the line. This will cause directionality problems for the dynamic mho characteristic. The characteristic expands for forward faults (inductive currents) and contracts for reverse faults (capacitive currents).

Fig.14 presents symmetrical currents at the right terminal. The magnitudes exhibit their minima at 45% and 85% of the line measured from the right terminal. Within this interval the negative- and zero-sequence currents are practically out of phase, while for faults close to the terminals, the currents are in phase. Normally the fault component of

the positive-sequence current and the zero- and negative-sequence currents are all in phase for a SLG (AG) fault. Therefore, in the sample system faults within the 45% to 85% interval may cause potential phase selection problems at the right terminal for algorithms that use relationships between the zero- and negative-sequence currents (the two cannot be out of phase for any known fault type on an uncompensated line).

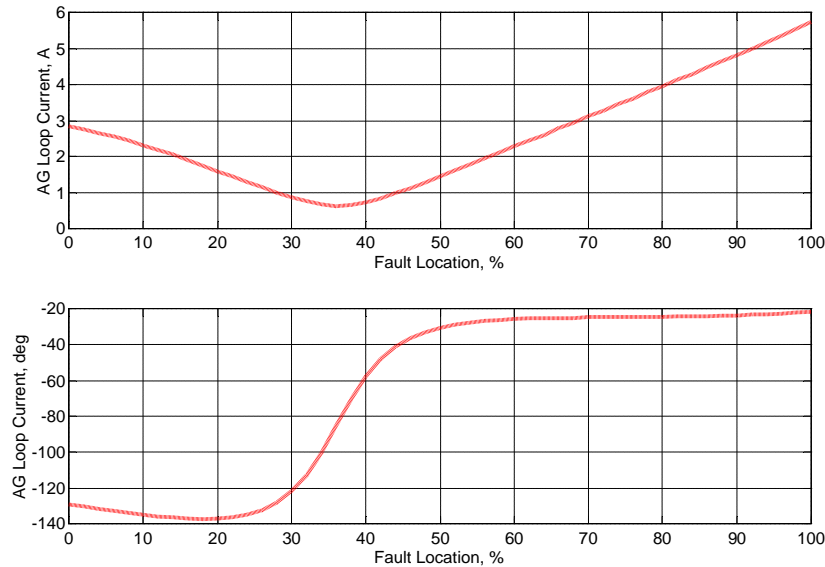

Figure 15. Fault loop current at the left terminal: magnitude (top) and phase angle (bottom).

Fig.15 presents the fault loop current (with the zero-sequence compensation setting as for a plain line) for the right-terminal relay. The current is significantly shifted from its natural position for faults close to the left terminal of the line.

Figs.16 and 17 show symmetrical voltages at the left terminal. Normally, for a SLG fault, the two voltages are out of phase as compared with the pre-fault positive sequence voltage. Due to series compensation the two voltages are significantly shifted from the natural positions. The line-side voltages are close to their natural position for close-in faults, but are some 110 degrees off for remote faults (Fig.16). The bus-side voltages are close to their natural position for remote faults (40 degrees off), but are significantly shifted for close-in faults (120 degrees off – Fig.17).

Fig.18 presents the symmetrical voltages at the right terminal. Their angular position is approximately correct: both zero- and negative-sequence voltages are within some 40-degree limit at the -180 -degree position. Magnitudes of the two voltages exhibit an interesting pattern: for faults at 45% and 85% from the right terminal, respectively, the voltages measured by the right-terminal relay are very small (practically zero). This would create some problems for negative- and zero-sequence directional elements, unless the elements are biased towards operation if the polarizing voltage is very low (known and preferred solution; see Section 5 for more details).

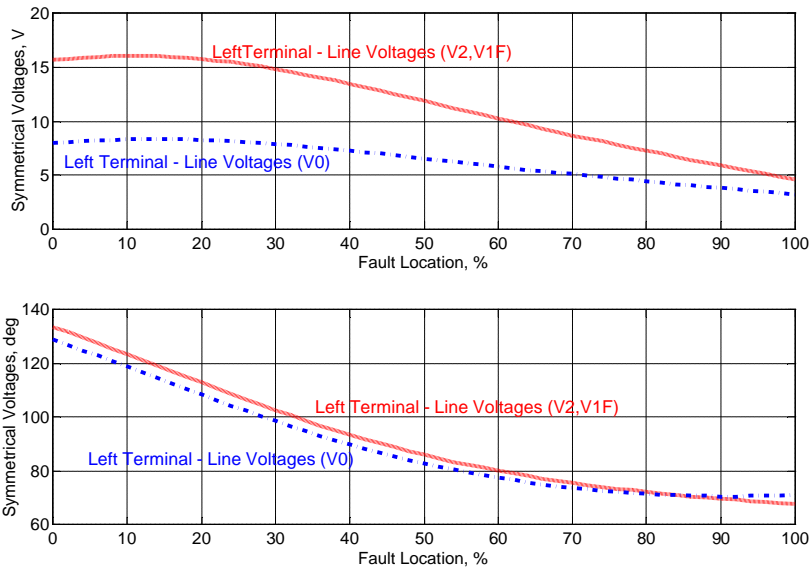

Figure 16. Symmetrical voltages – left terminal, line side VTs: magnitude (top) and phase angle (bottom).

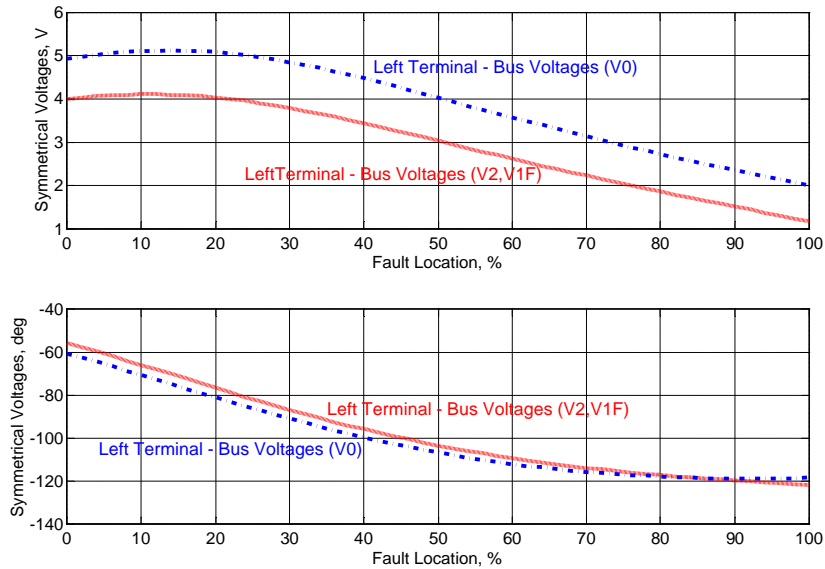

Figure 17. Symmetrical voltages – left terminal, bus side VTs: magnitude (top) and phase angle (bottom).

3.2. Voltage and Current Inversion

As practically illustrated in the previous subsection, various currents (fault, phase, fault loop, sequence) and voltages (phase, sequence) may exhibit significant phase shifts as compared with their natural positions. Terms “voltage inversion” or “current inversion” are not meaningful unless the “voltage” and “current” terms are defined as well as the term “inversion”. In this paper, an inversion is defined as a shift by more than 90 degrees from a “natural” position of a given phasor.

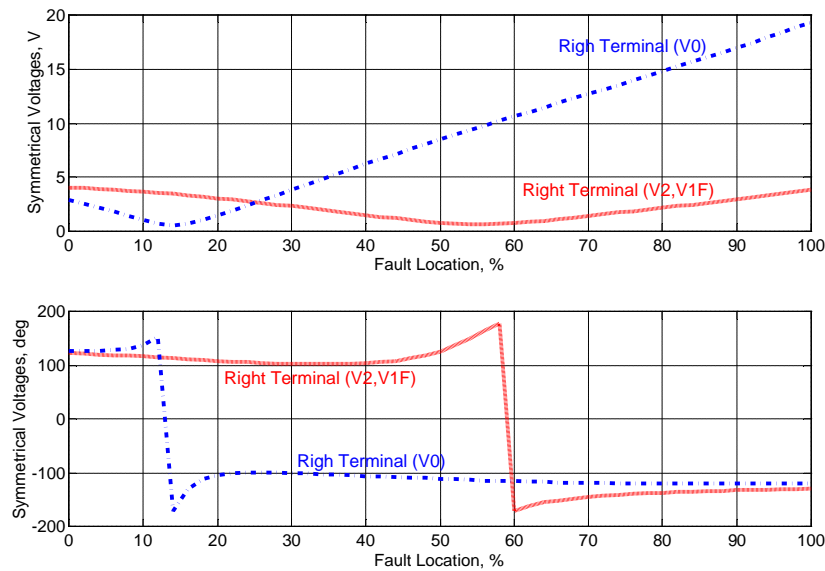

Figure 18. Symmetrical voltages – left terminal: magnitude (top) and phase angle (bottom).

Applying the above definition to the right terminal relay, it is concluded that none of the currents or voltages is inverted. Several signals exhibit significant phase displacements, but none is truly inverted.

The left-terminal relay experiences current and voltage inversions. Fig.19 illustrates the fault positions that cause inversion of particular signals. Specifically:

The zero-, negative-sequence (and the fault component of the positive-sequence) currents are inverted for faults beyond the SCs up to some 30-40% of the line length. Consequently, the faulted phase current and the ground loop currents are inverted as well. As seen in Fig.19a, there are fault locations for which only some of the aforementioned currents are inverted.

If the left relay is fed from the bus-side VTs (Fig.19b), the zero- and negative-sequence voltages are inverted for faults beyond the SCs, up to some 30-40% of the line length. If the relay is fed from the line-side VTs, the voltages are also inverted but for faults close to the right terminal.

The latter phenomenon may seem unexpected. It could be explained as follows. For faults close to the right terminal, the negative- and zero-sequence symmetrical networks from the fault point to the left electromotive force (e.m.f.) are inductive (Fig.8). So are the networks from the fault point to the right e.m.f. Consequently, the zero-, negative- and positive-sequence equivalent impedances seen from the fault point are inductive. The fault current is inductive and the sequence voltages at the fault point are not inverted. Since the negative- and zero-sequence voltages at the fault point are not inverted, and the networks are not capacitive, the negative- and zero-sequence currents at the left terminal are not inverted. The impedance, however, from the potential point (line-side VTs) back to the left e.m.f. is capacitive. The inductive negative-sequence current flowing through that capacitive impedance causes inversion of the negative-sequence voltage. This phenomenon does not happen for close in faults, when the negative-sequence current is in-

verted (Fig.19a), as the inverted current and capacitive impedance cause make the negative-sequence voltage to appear in its natural position.

The above simple method can be used to analyze inversions of all the relevant signals. What is interesting is that practically all the system parameters influence any particular inversion. For example, the zero-sequence impedance affects inversion of the fault current, thus inversion of the sequence voltage at the fault point, thus inversion of the negative-sequence current at a given terminal, thus inversion of the negative-sequence voltage at that terminal.

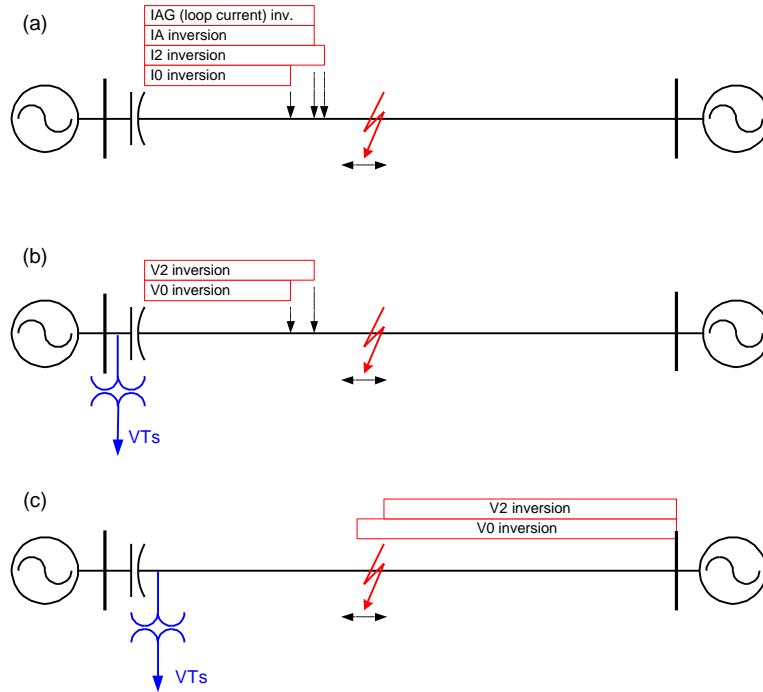

Figure 19. Fault locations causing current and voltage inversions at the left terminal relay: currents (a), voltages while using the bus-side VTs (b), and voltages while using the line-side VTs (c).

3.3. Response of Selected Comparators to Signal Inversion

As illustrated in the previous subsection various signals may invert or shift considerably for various fault locations. A practical “distance element” of a modern relay is built out of several mutually supervising comparators. Those comparators involve several different currents and voltages. The actual equations must be used in order to predict response of any particular comparator to faults on series compensated lines.

This subsection continues the previous example and examines responses of the following distance comparators:

100% memory-polarized dynamic mho

$$I_{AG} Z - V_{AG} \text{ versus } V_{1A_mem} \tag{12}$$

Zero-sequence current-polarized reactance

$$I_{AG} Z - V_{AG} \text{ versus } I_0 Z \tag{13}$$

100% memory-polarized negative-sequence directional

$$I_2 Z \text{ versus } V_{1A_mem} \tag{14}$$

100% memory-polarized zero-sequence directional

$$I_0 Z \text{ versus } V_{1A_mem} \tag{15}$$

where Z is the reach impedance.

One possible mho distance function could include conditions (12), (13), (14) and (15). One possible quadrilateral function could include conditions (13), (14) and (15).

Fig.20 presents the coverage of the comparators (12) through (15) for the right-terminal relay and the left-terminal relay fed from the bus-side VTs. The reach is set at twice the line impedance (uncompensated) and the overreaching zone is analyzed.

The mho comparator of the right-terminal relay covers only about 10% of the line. Combination of high fault resistance and signal inversions does not allow covering more despite the fact the reach is set at twice the line impedance.

The reactance characteristic has a gap in its coverage: it will not pickup for faults from about 60% to 90% of the line length measured from the right terminal.

The negative- and zero-sequence memory-polarized directional functions cover the entire line.

The response of both the mho and reactance comparators is unexpected as at the right terminal none of the signals is truly inverted. It is enough, however, for the signals to be shifted from their natural positions to cause problems.

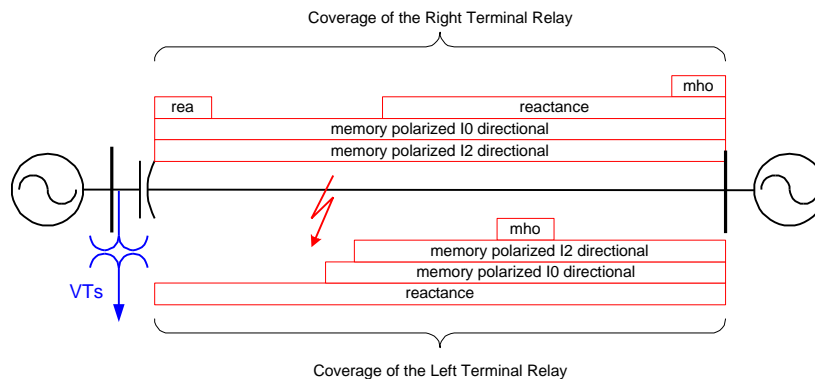

Figure 20. Coverage of various comparators while using the bus-side VTs.

The mho comparator of the left-terminal relay fed with the bus-side voltage will cover only some 10% of the line. The covered spot is unexpectedly in the middle of the

line. The comparator will not pickup close-in faults due to signal inversions. It will not pickup faults located further due to limited resistive coverage of the mho towards the reach point.

Surprisingly, the reactance function covers the entire line (despite the signal inversions). The negative- and zero-sequence memory-polarized directional elements exhibit blind spots for close-in faults because the currents are inverted (Fig.19a).

Fig.21 presents the coverage of the same line, but for the case when the left-terminal relay is fed from the line-side VTs. Situation is very similar except the mho comparator: it does not cover the line at all (again, the reach is set at twice the line impedance).

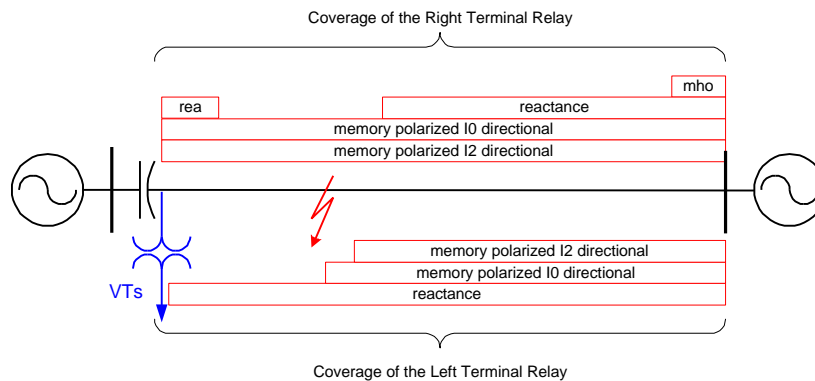

Figure 21. Coverage of various comparators while using the line-side VTs.

As illustrated in this section, several unusual phenomena may occur on series compensated lines under low-current fault conditions. Transients – specific to series compensation – complicate the situation even further.

4. Transients

Most transient problems for relays installed on series compensated lines are caused by sub-synchronous oscillations. Series capacitors, if not effectively by-passed by the gaps and/or MOVs during a fault, make the fault loop capacitive-inductive-resistive. Such a circuit has its own resonant frequency that is very close to the nominal system frequency. The resonant frequency depends on fault location and fault type as the equivalent circuit and its parameters vary. In any case, the sub-synchronous oscillations can be only 5-10Hz away from the system nominal frequency.

The sub-synchronous oscillations cannot be effectively filtered out by a relay unless very long data windows are applied for digital filters and the relay is significantly slowed-down. Typically, relays apply the same filtering techniques as for regular applications. As a consequence the phasors estimated by the relay follow the signal envelopes.

Sub-synchronous oscillations occur also in conjunction with high-current faults: during the fault the MOVs conduct and the circuit is well controlled. After the fault is cleared, however, the current drops, the MOVs stop conducting and the SCs are effectively re-inserted into the system. This results in large post-fault oscillations. High energy

stored in the line inductance during the fault contributes to the magnitude of those oscillations.

As an example, Figs.22 and 23 present a low-current SLG fault in a sample series compensated system.

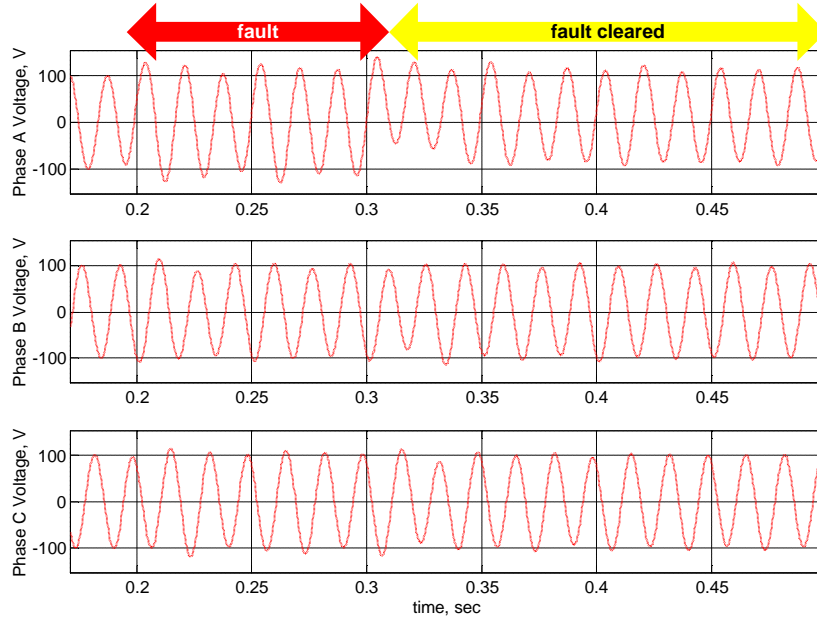

Figure 22. Sample fault on a series-compensated line: line-side VT voltages.

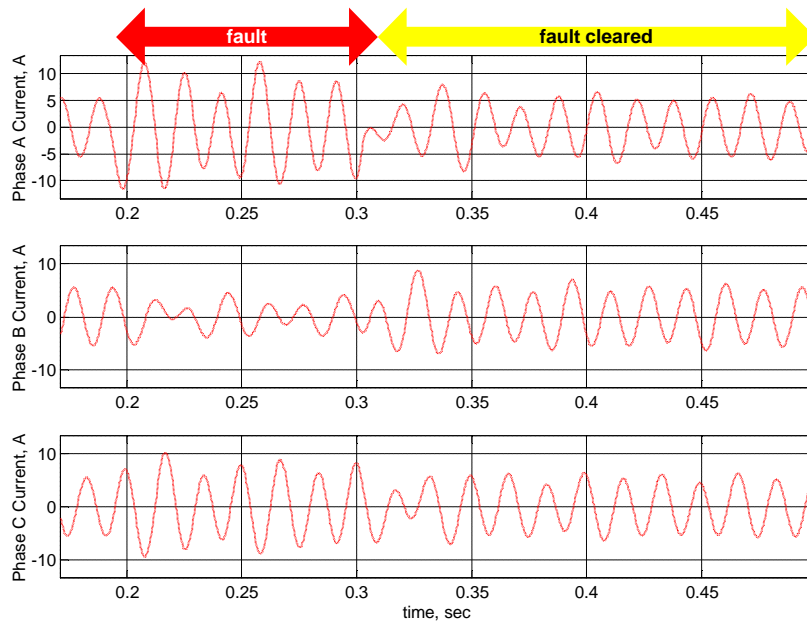

Figure 23. Sample fault on a series-compensated line: currents.

Heavy oscillations are visible in both currents and voltages. Relay frequency tracking may be one of the features severely affected by this kind of signal distortions. The zero-crossings of the waveforms fluctuate in time. If the frequency tracking is based on zero-crossing detection and is too fast, it may cause serious problems. If the frequency track-

ing is based on phasors, it is not free from errors either as the phasors will move during the fault as well due to the sub-synchronous oscillations. The frequency tracking does not have to be too fast. Therefore, averaging and/or other post-filtering such as median filtering solves the problem.

Figs.24 and 25 present plots of the voltage and current magnitudes measured using one-cycle digital estimators (variations of the Fourier algorithm). As seen from the figures, the estimated magnitudes follow the envelopes of their waveforms.

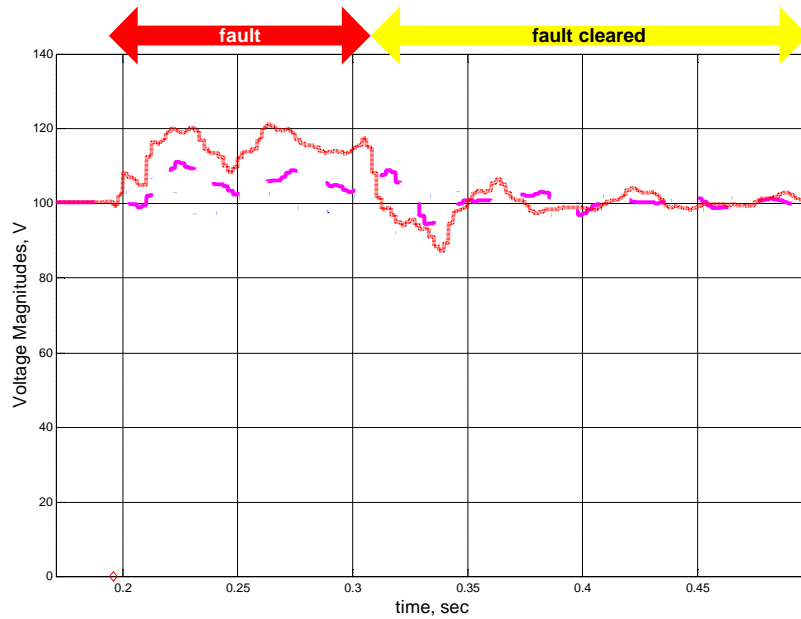

Figure 24. Sample fault on a series-compensated line: voltage magnitudes.

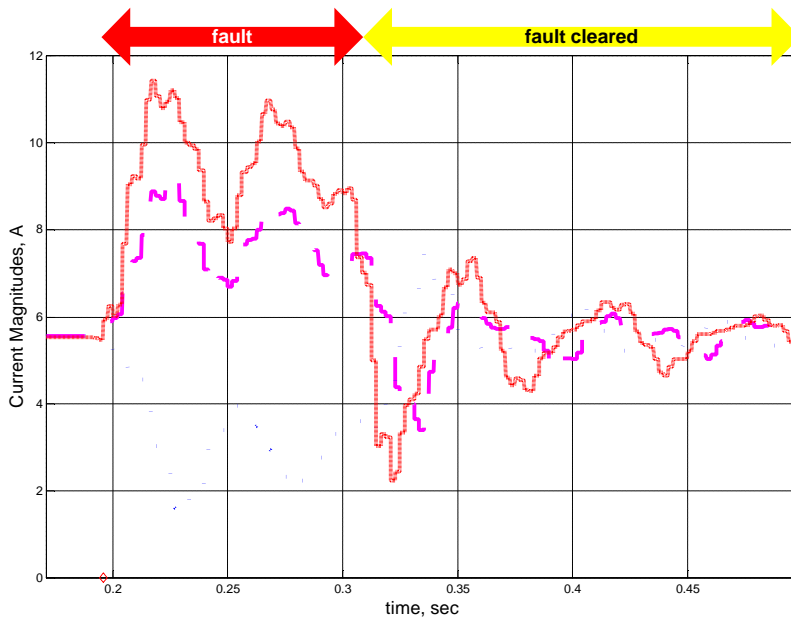

Figure 25. Sample fault on a series-compensated line: current magnitudes.

The sub-synchronous oscillations take significant effect on transient accuracy of distance functions. In addition to the steady-state overreach resulting from the degree of compensation, significant transient overreach must be taken into account when setting underreaching distance functions.

Taking into account all the sources of error (50-70% of steady-state overreach, 10-20% due to VT/CT/impedance errors, and 10-30% of the transient overreach), it turns out an underreaching distance zone cannot be practically set. Section 6 presents a solution to this problem.

5. Negative- and Zero-Sequence Directional Elements

As illustrated in Sections 3 and 4 an overreaching distance element may not pickup all low-current faults on the protected line. In addition, an underreaching distance zone cannot be set to cover a sizeable portion of the protected line if the SCs are located between the relay potential source and the far-end busbar, or there are other series compensated lines originating from the far-end busbar that have their SCs installed in the far-end substation.

One solution to this problem relies on ground directional elements such as negative-sequence or zero-sequence for pilot-aided schemes and on a current-controlled adaptive reach approach to underreaching distance elements. This section describes the first, while the next section describes the second part of the solution.

5.1. Offset Impedance Approach to Ground Directional Elements

Fig.26a shows a negative-sequence voltage profile for a forward fault, while Fig.26b shows the vector diagram for the involved negative-sequence signals. Normally, the current lags the inverted voltage by the angle of the negative-sequence impedance measured from the potential source back to the local equivalent system. Therefore, the polarizing and operating quantities are defined as:

$$S_{pol} = -V_2, \quad S_{op} = I_2 \cdot 1 \angle ECA \quad (16)$$

where ECA is an Element Characteristic Angle, set as explained above.

For applications on plain lines, there is a danger that the polarizing signal (negative-sequence voltage) may be too low to ensure reliable operation for forward faults. This may happen if the local equivalent system is very strong. Adding a small voltage to the polarizing signal in phase with the operating signal solves the problem. Consequently, the offset-impedance directional element is defined as follows.

Forward-looking (“tripping”) negative-sequence directional element:

$$S_{pol} = -V_2 + I_2 \cdot Z_{offset} \cdot 1 \angle ECA, \quad S_{op} = I_2 \cdot 1 \angle ECA \quad (17a)$$

Reverse-looking (“blocking”) negative-sequence directional element:

$$S_{pol} = -V_2 + I_2 \cdot Z_{offset} \cdot 1 \angle ECA, \quad S_{op} = -I_2 \cdot 1 \angle ECA \quad (17b)$$

As shown in Fig.26b, the offset impedance increases the polarizing signal and ensures proper operation.

Fig.26c shows the voltage profile for a reverse fault. During a reverse fault, the voltage at the relaying point is at least the line impedance times the current at the relaying point. The offset impedance reduces the polarizing signal, but the element responds correctly as long as the offset impedance is lower than the line impedance plus the impedance of the remote system (Fig.26d).

For applications on non-compensated lines, the offset impedance is set at the level of 10-25% of the line impedance. This improves speed of operation, and guarantees detection of forward faults even in very strong systems.

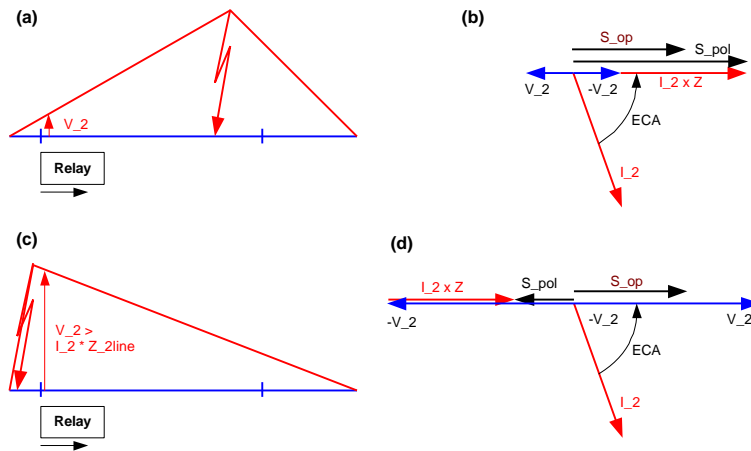

Figure 26. Negative-sequence currents and voltages for a forward ((a) and (b)) and reverse ((c) and (d)) faults.

This known principle can be used on series-compensated lines resulting in a very robust, dependable and secure directional element.

If, on a series compensated application, the negative-sequence voltage gets inverted, a wrong directional indication will be given. However, if the offset impedance is high enough, the wrong direction is counterbalanced and the element responds correctly.

The same principle applies to the zero-sequence directional element.

5.2. Setting Recommendations for the Offset-Impedance Directional Elements

The relation between the negative-sequence voltage and current at the relaying point is entirely determined by the negative-sequence impedance measured from the potential source of the relay back to the e.m.f. of the local equivalent system. If this impedance is inductive, the negative-sequence voltage and current are in a “natural” relationship. If this impedance is capacitive, the relationship is such that the directional identification is wrong. The above results in very straightforward setting recommendations:

1. If the net impedance between the relay potential source and the e.m.f. of the local equivalent system is inductive, then no offset impedance is needed. If the impedance is capacitive, then the offset shall be at least the reactance of such

net capacitive impedance. This ensures that the element operates on all forward faults within its reach.

2. The offset impedance cannot be higher than the net inductive impedance between the relay potential point and the e.m.f. of the remote equivalent system. Otherwise, the element is overcompensated and will pick up on reverse faults.

Consider the system of Fig.7. Neglecting the angle differences between the involved impedances one calculates the following settings:

Negative-sequence Directional Element of the Right Relay:

$Z_{\text{offset}} > 0$ (no need for offset as the impedance behind the relay is inductive)

$Z_{\text{offset}} < 10-7+1.43 = 4.43 \text{ ohm}$ (the offset cannot be higher than the net impedance from the potential source to the forward e.m.f.)

Zero-sequence Directional Element of the Right Relay:

$Z_{\text{offset}} > 0$

$Z_{\text{offset}} < 30-7+2.68 = 25.6 \text{ ohm}$

Negative-sequence Directional Element of the Left Relay (line-side VTs):

$Z_{\text{offset}} > -(-7+1.43) = 5.57 \text{ ohm}$ (offset higher than 5.57 ohm must be applied otherwise forward faults will not be detected)

$Z_{\text{offset}} < 10+3.44 = 13.44 \text{ ohm}$ (the offset cannot be higher than the net impedance from the potential source to the forward e.m.f.)

Zero-sequence Directional Element of the Left Relay (line-side VTs):

$Z_{\text{offset}} > -(-7+2.68) = 4.32 \text{ ohm}$

$Z_{\text{offset}} < 30+16.4 = 46.4 \text{ ohm}$

Negative-sequence Directional Element of the Left Relay (bus-side VTs):

$Z_{\text{offset}} > 0$ (no need for offset as the impedance behind the relay is inductive)

$Z_{\text{offset}} < -7+10+3.44 = 6.44 \text{ ohm}$ (the offset cannot be higher than the net impedance from the potential source to the forward e.m.f.)

Zero-sequence Directional Element of the Left Relay (bus-side VTs):

$Z_{\text{offset}} > 0$

$Z_{\text{offset}} < -7+30+16.4 = 39.4 \text{ ohm}$

If the system of Fig.6 may change configuration significantly, the original system shall be considered rather than the equivalent shown in Fig.7. Consequently, the settings may be different.

Offset negative- and zero-sequence directional elements offer an excellent directional integrity for pilot aided schemes. They not only guarantee correct operation on series

compensated lines, regardless of the location of the VTs and SCs, but also are fast and sensitive [3].

As long as the protected network is not overcompensated, the element can always be set, i.e. the two setting rules can always be satisfied.

6. Adaptive Distance Reach

As illustrated in section 3 distance functions do not offer reliable protection for low-current faults when applied to series compensated lines. First, they may fail to pick up internal faults, even when significantly overreaching the protected line. Second, for an underreaching direct tripping operation they must be set very conservatively, sometimes as low as 10-20% of the line in order to avoid overreaching due to sub-synchronous oscillations.

One solution to the problem of effective application of distance protection to series compensated lines is to use a current-controlled adaptive reach method. In this solution the reach of a distance function is reduced by the following value:

$$Z_{effective}(|I|) = Z_{SET} - \frac{V_{LIM}}{|I|} \cdot 1 \angle angle(Z_{SET}) \quad (18a)$$

The effective reach is a function of the magnitude of the loop current, I . The reduction of reach takes place along the maximum torque angle line: the higher the current, the smaller the reduction. For very large currents, the reach is pulled back by a very small percentage. On the other hand, for currents below certain value, the distance element is effectively blocked:

$$|I| < \frac{V_{LIM}}{|Z_{SET}|} \rightarrow block \quad (18b)$$

The V_{LIM} value is a setting and shall be set as a sum of voltage protection levels of all the SCs from the relay potential point up to the point where the zone must not reach.

Fig.27 illustrates the adaptive reach approach: for currents that cause the voltage drop below the voltage protection level across any SC within the intended reach, the reach is pulled back entirely and the zone is practically blocked. For larger currents that cause the MOVs and/or air gaps to conduct some current, stabilizing sub-synchronous oscillations and reducing an effective overreach due to the SCs, the reach is reduced accordingly. For very large currents, when the SCs are practically completely by-passed, the reach is not reduced at all.

This approach gives maximum security, but at the same time allows covering up to traditional 80-85% of the line with the underreaching distance zone if the fault current is high enough to ensure suitable operating conditions for the distance protection principle. Low-current faults are covered by the ground directional functions.

Fig.28 illustrates the adaptive reach approach. Low-current faults at the reach point will cause significant steady-state overreach and extra transient overreach due to sub-

synchronous oscillations. In such conditions (Fig.28a), the reach is reduced considerably so that the zone does not overreach. During high-current faults at the reach point (Fig.28b), the zone reach is not reduced, but at the same time there is no need to reduce it as the effective Goldsworthy’s reactance is small and there are no sub-synchronous oscillations. High-current internal faults are covered as in traditional applications because the reach is not reduced (Fig.28c).

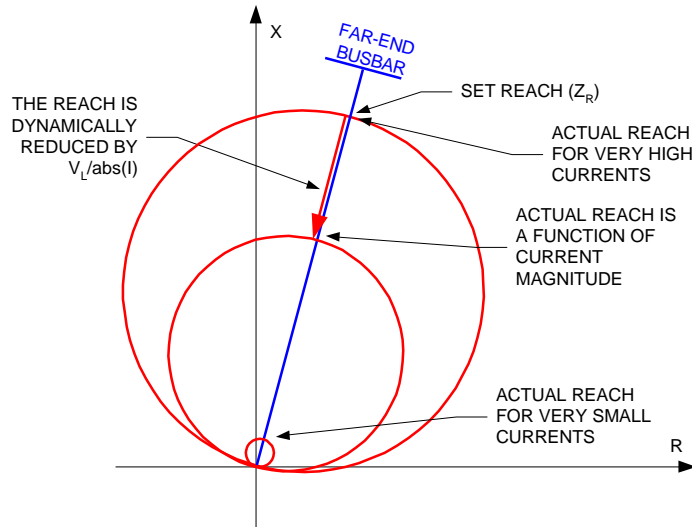

Figure 27. Current-dependent adaptive reach.

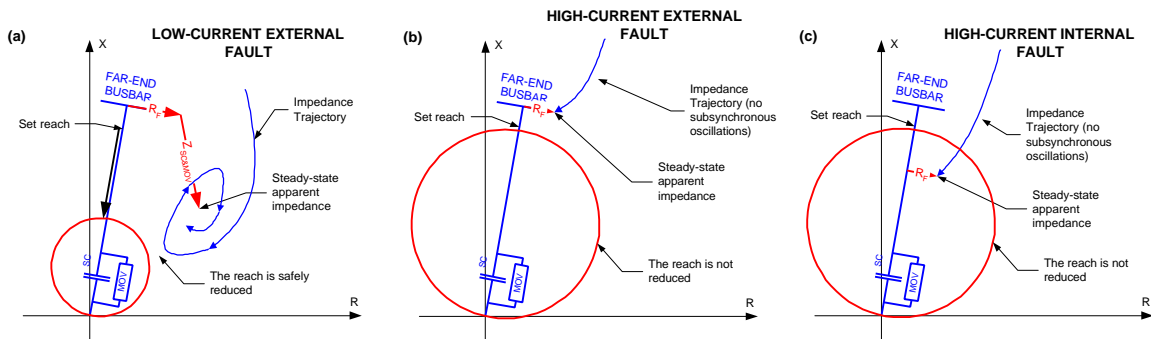

Figure 28. Illustration of the current-dependent adaptive reach.

For overreaching zones, the V_{LIM} setting shall be set at zero.

For an underreaching zone, the V_{LIM} setting shall be set as a sum of the voltage protection levels for the SCs between the relay potential point and the intended reach point. For example, for the system of Fig.6, the following settings apply:

Right-terminal Relay:

V_{LIM} = sum of the voltage protection levels of the 7-ohm and 5-ohm SCs (the right terminal Zone-1 must not overreach for faults beyond the 5-ohm SC when the 2-ohm equivalent system is disconnected or becomes very weak).

Left-terminal Relay (bus-side VTs):

V_{LIM} = sum of the voltage protection levels of the 7-ohm and 12-ohm SCs (the left terminal Zone-1 must not overreach for faults beyond the 12-ohm SC).

Left-terminal Relay (line-side VTs):

V_{LIM} = the voltage protection level of 12-ohm SCs.

Using the current-controlled adaptive reach approach one may set the underreaching zone very aggressively, at 80-85% of the impedance of a non-compensated line.

7. Phase Selection for Single-Pole Tripping

Series compensated lines are strong links in transmission backbones of power systems. Many utilities choose to apply single-pole tripping in order to keep the two healthy phases in services on SLG faults and maintain reduced power transfer.

Fast and accurate phase selection is critical for single-pole tripping. The following issues need to be considered for accurate phase selection.

Signal inversions during low-current faults may lead to wrong fault identification. The impact depends on a particular phase selection method used by a relay.

Sub-synchronous oscillations may cause additional problems because the signals measured by the relay – typically phasors – are estimated with large errors.

For high-current faults, however, phase selection on series compensated does not impose more problems as compared with plain non-compensated lines.

One phase selecting algorithm uses a hierarchical approach to the fault type recognition [4]. Firstly currents are used for phase selection. If the currents fail to recognize the fault, the voltages are utilized. Both currents and voltages are analyzed in terms of angular relationships between the positive-, negative- and zero-sequence signals.

In the first step magnitudes of the fault component of the positive-sequence, negative-sequence and zero-sequence signals are checked. The thresholds – intended for confirming if a given component is large enough to provide extra information on the fault type – are adaptive: carefully selected portions of both positive- and zero-sequence currents are used as adaptive thresholds. Once a given symmetrical component is validated, its angular position with respect to the two other components is checked using the well-known fault patterns shown in Fig.29.

The relation between the positive- and negative-sequence currents is always checked. If the zero-sequence current is also present, the relation between the negative- and zero-sequence currents is checked as well. If both positive-to-negative and negative-to-zero fault patterns are checked, they must agree in order to identify a given fault type.

If the currents fail to recognize the fault, the voltages are used in exactly same manner. The currents may fail during weak infeed conditions, when the zero-sequence current from close-in transformers may dominate the positive- and negative-sequence currents practically destroying any asymmetry in the phase currents and making phase selection impossible. If this is a case, the voltages show a great deal of asymmetry (weak system)

allowing the relay to recognize the fault type. If the voltages fail (cross country faults with the internal fault away from the relaying point, for example), the algorithm uses an underreaching distance zone to determine the fault type. The latter is likely to be correct in such circumstances.

By utilizing two fault patterns, the algorithm is more secure. As explained and illustrated in [4], the algorithm is very fast because it uses phase angles of signals that are zeros in the pre-fault state, and as such are not biased in any particular direction. For example, despite the oscillations and similar level of magnitudes of current in all three phases, the waveforms shown in Fig.23 are recognized correctly as an AG fault using 2-msec worth of data.

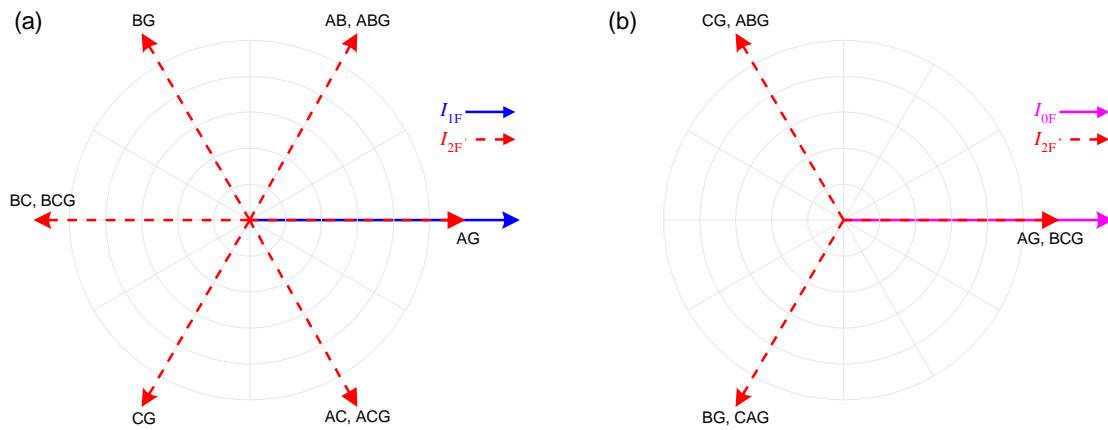

Figure 29. Negative-sequence vs. positive-sequence fault signature (a) and negative-sequence vs. zero-sequence fault signature (b).

During cross-country faults and/or due to problems with series compensation phase selection may present some problems. However, it is very unlikely that phase selectors at both terminals would misoperate. If one relay fails to recognize the fault correctly, multi-bit communication schemes as the ones presented in [4] ensure proper operation in majority of troublesome cases. In a multi-bit scheme a relay uses more than one bit to send a permissive or blocking signal to its peer. In this way extra information on the fault type can be exchanged between the relays. Nowadays, with advances in relay communications systems, using more than one bit for signaling schemes is not very difficult nor expensive, and shall be considered for single-pole tripping applications in difficult conditions such as series compensation.

8. Fault Location

Because series compensated lines are typically long, accurate fault location is essential. Fault location in series compensated lines presents, however, even bigger challenge than distance protection. While reach accuracy, directional integrity and dependability are the only requirements for a distance function, ability to pinpoint accurately any fault on the line is the requirement for a fault locator.

Several families of fault locating algorithms have been proposed in the past ranging from single-ended impedance-based approaches to traveling-wave-based techniques. Majority of commercially available fault locators either provided as a part of a Digital Fault Recorder (DFR) software package, stand alone device or integrated with digital relays, are based on fundamental frequency voltages and currents, thus on the apparent impedance.

Single-ended impedance-based algorithms make use of a set of equations that is under-stated, e.g. one equation is missing in order to perform fault location calculations. Various assumptions are made (such as the fault components of the currents from both ends of the line being in phase, fault impedance being pure resistance, or local and remote system equivalent impedances known) in order to generate the missing equation and derive a fault location algorithm. Various assumptions yield various fault locating methods.

Double-ended algorithms use an over-stated set of equations, e.g. depending on the amount of data measured at both terminals one may generate more equations than unknowns. This allows the locator to avoid using data that may not be accurate (such as the zero-sequence impedance of the line) and improve accuracy of fault location.

Regardless of the approach taken, the impedance algorithms solve a set of equations that describes a simplified electrical circuit for the unknown being the fault point (and as a by-product – the fault resistance). If the series capacitors and MOVs are not part of those equations, fault location cannot be accurate. Traditional algorithms may show up to 20% of error when applied on series compensated lines [2].

There are several difficulties as far as a successful fault location in series compensated lines is considered.

First, the non-linear current-dependent impedance of the Goldsworthy's model must be taken into account. This impedance depends on the through current and makes the equations non-linear. In addition, the sequence networks representing a three-phase bank of SCs and MOVs are mutually coupled. The coupling cannot be neglected when locating faults due to accuracy requirements. Consequently, the equations cannot be solved when designing an algorithm, and the fault locator must solve them numerically.

Second, there may be one or two compensating banks installed on the line at various locations. This calls for several parallel algorithms, or "fault locators" that assume a fault on a separate section of the line. Each such sub-algorithm delivers its own fault location estimate. A separate selection procedure must be developed to decide on the most likely fault location, or at least prioritize the results for the inspection crew.

Third, single-ended methods do not measure the currents at the remote terminal. If there is series capacitor between the fault and the remote terminal, the Goldsworthy's model cannot be easily applied in a single-ended method because the through current of the compensating bank cannot be measured directly. Still, the operating point of the SCs and MOVs affects the accuracy of fault location. One solution to this problem is to solve for the remote currents interactively [2,5]. The solution, however, requires the equivalent impedance of the remote system.

Fourth, if relays protecting the line trip fast, there may be a very short window of data available to the fault locator. Presence of sub-synchronous oscillations may affect considerably accuracy of phasor estimation, and consequently, fault location.

Fifth, for slow relay/breaker operations, the MOVs may accumulate their maximum allowable energy and may get by-passed by the gaps triggered from the MOV thermal protection. If this happens, the available data window, although long, is divided into several sections, each corresponding to a different network topology (MOVs on and by-passed). Each section of the recording may be too short to perform accurate fault location.

One impedance-based fault-locating algorithm developed specifically for series compensated lines [2,5] applies the Goldsworthy's equivalent impedances. Instead of using fault-loop approach, the algorithm solves the equations in the natural three-phase coordinates (i.e. for the phase voltages and currents). For a line with one SC bank on the line, the algorithm runs two internal "fault locators": one assumes the fault between the relay and the SCs, the other assumes the fault beyond the SCs. A separate selection algorithm is proposed to indicate the correct alternative.

9. Conclusions

Protective relaying problems specific to series compensated lines are encountered to their fullest extent only during low-current faults. Low-current faults can happen either in weak systems or due to large fault resistances. In the former case, the effect of series compensation is practically canceled by large inductive impedance of the system. The latter case can practically happen only during SLG faults. While a general analysis of a series compensated system is quite difficult (Goldsworthy's equivalent, mutual coupling between the sequence networks), the primary case to be considered for practical reasons is a straightforward situation of a low-current SLG fault.

Generally, an optimal zero-sequence compensating factor for ground distance protection is a complex function of fault location and fault current. Practically, the value calculated from the line parameters may be used as other factors affecting accuracy of ground distance protection are of much higher significance.

Both bus-side and line-side locations of the relay potential source create their own problems. Using line-side voltages does not simplify series compensation applications. The series capacitors are still there, either in the forward or reverse direction.

Distance protection faces serious difficulties during low-current faults on, or in a vicinity of series compensated lines. Distance protection overreaches due to series compensation, is exposed to large errors due to sub-synchronous oscillations, and may fail to detect internal faults due to signal inversions. An underreaching zone must be pulled back drastically protecting only small portion of the line. Overreaching zones face dependability limitations even if their reach is very large.

Ground (negative-sequence and neutral) directional functions offer an excellent alternative to the overreaching distance protection. The offset impedance approach ensures

very good directional integrity regardless of the degree of series compensation, as well as location of series capacitors and voltage transformers.

Current-controlled adaptive reach is a preferred solution to the steady-state and transient overreaching problems for the directly tripping distance zone. The solution offers maximum security and at the same time allows tripping high-current faults within traditional 80-85% of the line length.

Single-pole tripping is also exposed to problems associated with series compensation. Advanced phase selecting algorithms and multiple-bit pilot-aided schemes improve performance of the protection systems.

Fault location on series compensated lines is affected to a great extent. Traditional algorithms may exhibit errors at the level of 20%. Traveling wave-based algorithms and novel impedance-based methods developed specifically for series compensation are much more accurate.

Despite constantly increasing power demand, series compensated lines are still quite rare. It is worth to undertake an effort to simulate transient conditions for series compensated applications, fine-tune and verify settings, and finally test the relaying system using digital simulators and/or play back systems.

10. References

- [1] GOLDSWORTHY D.L., "A linearized model for MOV-protected series capacitors", *IEEE Transactions on Power Systems*, Vol.2, No.4, pp.953-958, November 1987.
- [2] SAHA M.M., IZYKOWSKI J., ROSOŁOWSKI E., KASZTENNY B., "A new accurate fault locating algorithm for series compensated lines", *IEEE Transactions on Power Delivery*, Vol.14, No.3, July 1999, pp.789-797.
- [3] KASZTENNY B., SHARPLES D., CAMPBELL B., POZZUOLI M., "Fast Ground Directional Overcurrent Protection—Limitations and Solutions", *Proceedings of the 27th Annual Western Protective Relay Conference*, Spokane, WA, October 24-26, 2000.
- [4] KASZTENNY B., CAMPBELL B., MAZEREEUW B., "Phase Selection for Single-Pole Tripping – Weak Infeed Conditions and Cross Country Faults", *Proceedings of the 27th Annual Western Protective Relay Conference*, Spokane, WA, October 24-26, 2000.
- [5] SAHA M.M., HILLSTROM B., IZYKOWSKI J., ROSOŁOWSKI E., KASZTENNY B., "A method of fault location for series-compensated lines", Patent WO99/32894, issued July 1, 1999.



Biographies

Bogdan Kasztenny received his M.Sc. and Ph.D. degrees from the Wrocław University of Technology (WUT), Poland. He joined the Department of Electrical Engineering of WUT after his graduation. Later he was with the Southern Illinois University in Carbondale and Texas A&M University in College Station. From 1989 till 1999 Dr. Kasztenny was involved in a number of research projects for utilities, relay vendors and science foundations. Since 1999 Bogdan works for GE Power Management as a Chief Application Engineer. Bogdan is a Senior Member of IEEE, has published more than 100 technical papers, and is an inventor of 5 patents. His interests focus on advanced protection and control algorithms for microprocessor-based relays, power system modeling and analysis, and digital signal processing.