

Controlled Switching of HVAC Circuit Breakers: Application Examples and Benefits

Dan Goldsworthy and Tom Roseburg, *Bonneville Power Administration*
Demetrios Tziouvaras and Jeff Pope, *Schweitzer Engineering Laboratories, Inc.*

Abstract—Controlled switching technology, that is, predefined controlled strategies for closing and/or opening each independent circuit breaker pole, is an effective way to reduce switching transients, prevent equipment failures, and improve power quality.

The paper presents a tutorial on controlled switching of high-voltage ac (HVAC) circuit breakers and describes the controlled switching theory and technology that is in use today. The paper discusses the benefits of controlled switching and shares one utility's applications and experiences with the controlled switching of shunt capacitors, shunt reactors, transformers, and lines, using modern protective relays and control devices. The paper also discusses how to select the optimum controlled switching times to reduce switching transients.

I. INTRODUCTION

Utility systems around the world have been designed as cost-effective ways of getting power to their industrial, commercial, and residential consumers. In the spirit of cost-effective power delivery, the customers and the utility routinely accept a certain level of disturbances, including faults, equipment failures, and switching events. Complaints about disturbances can usually be answered with "That is the way the power system works." However, most utilities still strive for higher reliability and fewer disturbances with better equipment, redundancy, overhead ground wires, and even transmission line arresters. New technologies with cost-effective ways of reducing disturbances provide utility engineers with more tools for improving electrical service to their customers.

One such technology that is improving rapidly, is becoming cost-effective, and is growing into an established, reliable method of reducing disturbances is controlled switching. While most faults and equipment failures cannot be prevented and must be endured, transients from switching are something a utility does to itself and its customers. Controlled switching methods, which control breakers and circuit switchers more precisely, are another tool available for utility engineers to improve their system and their quality of service.

Switching of shunt capacitors, shunt reactors, transmission lines, and power transformers creates electrical transients that may cause equipment failures, power quality problems, and protective relay misoperations.

Shunt capacitor energization causes inrush currents, overvoltages, circuit breaker contact erosion, mechanical and dielectric stresses in the capacitor bank and other equipment in the substation, ground potential rise, and coupled transients in control and protection cables. Shunt capacitor switching can

also cause overvoltages at the end of radial transmission lines and in the medium and low voltage networks connected to the secondary windings of transformers at the end of these lines.

Shunt reactor de-energization typically causes reignitions that can lead to circuit switcher and breaker failures. Furthermore, the high magnitude dc offset currents that result from energization of shunt reactors at an unfavorable instant can cause power transformer saturation.

Transformer energization can generate high-amplitude inrush currents that stress the transformer windings; it can also cause prolonged temporary harmonic voltages, degradation of the quality of electric supply, and misoperation of protective relays.

The paper presents a tutorial on controlled switching of high voltage ac circuit breakers, the application experiences of Bonneville Power Administration (BPA), and the controlled switching technology presently in use.

II. PRINCIPLE AND BENEFITS OF CONTROLLED SWITCHING

Conventional methods to reduce the magnitude and impact of switching transients have included applying pre-insertion resistors or reactors, current-limiting reactors, or surge arresters. However, methods for reducing switching transients when switching equipment such as transformers and reactors are rarely used. Controlled opening and closing of HVAC breakers offers an alternative to conventional methods.

Controlled switching of HVAC circuit breakers is becoming more widely available for switching shunt capacitors, shunt reactors, transformers, and transmission lines. Controlled switching provides many technical and economical benefits. Some of the most important advantages are the reductions of high inrush currents, dangerous switching overvoltages, equipment failures, and maintenance of circuit breakers that are switched quite frequently.

In this section, we discuss the principle of controlled switching, the mechanical variations of circuit breaker operating times, and the influence of prestrikes, as well as the technical and economical benefits of controlled switching.

A. Principle of Controlled Switching

Controlled switching is a technique that uses an intelligent electronic device, i.e., a modern numerical relay or a controller, to control the timing of closing and opening of independent pole breakers with respect to the phase angle of an electrical reference voltage or current signal.

The desired repeatability and accuracy of current conduction at a specific point on the waveform is often ± 1 ms

or less, and requires that the breaker be constructed so that it provides this consistency under all operating and ambient conditions. Alternatively, the controller issuing the breaker close commands for the point-on-wave operations must be able to measure the operational variables such as dc control voltage, ambient temperature, and idle time, and remove the effect of these variations by compensating the breaker control signal timing.

1) Controlled Opening

Controlled opening refers to controlling the contact separation of each circuit breaker pole with respect to the phase angle of the current. Controlling the point of contact separation determines the arcing time of the contacts to help prevent breaker and circuit switcher failures and to minimize stress and disturbances to the power system. The implementation of controlled opening is approximately the same regardless of the equipment being switched. The control is straightforward once timing data for a breaker is available, particularly the time from energizing the trip coil to contact separation. Although controlled opening is best done using the current through the breaker, the bus voltage can be used if the voltage-current phase relationship is always known, such as for shunt reactor and shunt capacitor switching.

The breaker is controlled so that its contacts will part just after a current zero. As the contacts continue to open they draw out an arc that will extinguish less than a half-cycle later at the next current zero. When the arc does extinguish, the contacts have been separated as far apart as practical, which provides the maximum dielectric strength available for the circumstances. This gives the breaker its best chance of successfully withstanding the recovery voltage and not having a reignition or a restrike. Reignition is a dielectric breakdown that reestablishes current within 90 electrical degrees of interruption. Restrike is a dielectric breakdown after 90 degrees.

Fig. 1 shows the timing sequence for controlled opening [1]. The control command is issued randomly with respect to the phase angle of the reference signal at an instant t_{command} . The randomly received opening command is delayed by the controller by some time, T_{total} , which is the sum of an intentional synchronizing time delay, T_{cont} , and a certain waiting time interval, T_w . T_{cont} is calculated with respect to a relevant zero crossing which is a function of the opening time, T_{opening} , and by the target phase angle of the time instant of contact separation, t_{separate} .

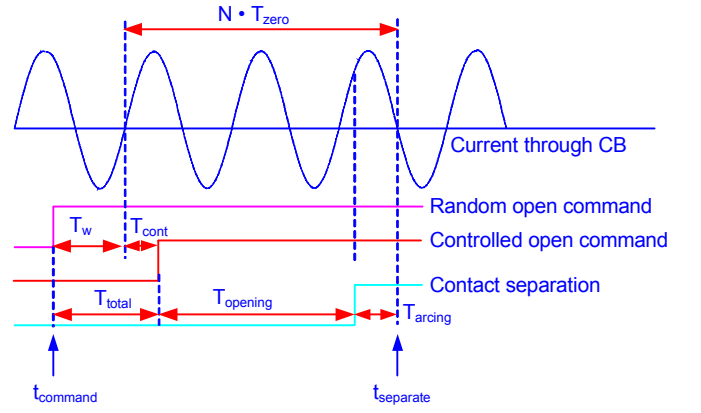

Fig. 1. Controlled opening sequence

$$T_{\text{total}} = T_w + T_{\text{cont}} \quad (1)$$

$$T_{\text{cont}} = N \cdot T_{\text{zero}} - T_{\text{arcing}} - T_{\text{opening}} \quad (2)$$

Accurate control of t_{separate} , which is the instant of contact separation, with respect to the next current zero at which arc extinction occurs, effectively defines the arcing time, T_{arcing} . The mechanical opening time, T_{opening} , is the time interval from energization of the breaker trip coil to the start of breaker contact separation. $N \cdot T_{\text{zero}}$ is an integer number of half cycles required to achieve a positive value of T_{cont} shown in Fig. 1.

2) Controlled Closing

Controlled closing refers to controlling the point of conduction of each pole of the breaker with respect to the phase angle of the voltage. Breakers used in these applications must be constructed to provide the consistency to successfully repeat the controlled closing operations.

The controller monitors the source voltage for a controlled closing operation. The closing command is issued randomly with respect to the phase angle of the reference signal at some instant, t_{command} , as shown in Fig. 2 [1]. The example sequence shown in Fig. 2 relates to closing of an inductive load, where the optimum closing instant is at a voltage peak assuming that the prestrike time is less than one-half cycle. The controller delays the randomly received closing command by some time, T_{total} , which is the sum of an intentional synchronizing time delay, T_{cont} , and a certain waiting-time interval, T_w . T_{cont} is determined by the mechanical closing time of the circuit breaker, the prestriking time, $T_{\text{prestriking}}$, and the actual phase angle of the target-making instant.

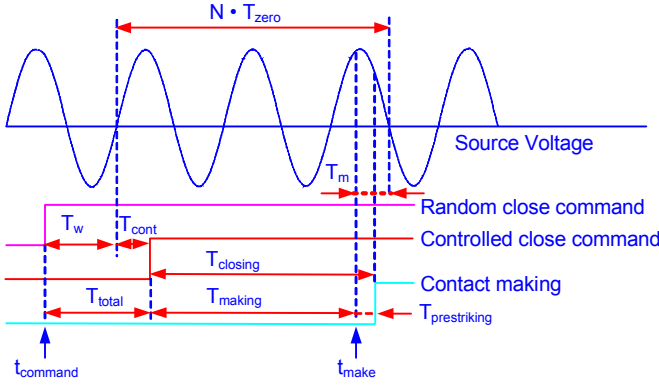

Fig. 2. Controlled closing sequence

The controller introduces delay T_{cont} with respect to a relevant zero crossing that is calculated by assuming circuit breaker closing time, T_{closing} , and prestriking time, $T_{\text{prestriking}}$. The current starts to flow at time t_{make} and the corresponding interval, T_m , is defined with respect to the following zero crossing from t_{make} .

The closing time, T_{closing} , is the time from circuit breaker closing coil energization to when the mechanical contacts touch. The prestriking time, $T_{\text{prestriking}}$, is the time interval that elapses between the instant of prestrike and contact touch. The making time, T_{making} , is the time interval from closing coil energization to t_{make} .

$$T_{\text{total}} = T_w + T_{\text{cont}} \quad (3)$$

$$\begin{aligned} T_{\text{cont}} &= N \cdot T_{\text{zero}} - T_m - (T_{\text{closing}} - T_{\text{prestriking}}) \\ &= N \cdot T_{\text{zero}} - T_m - T_{\text{making}} \end{aligned} \quad (4)$$

The controller takes into account variations of circuit breaker operating times and prestrike characteristics as required by specific applications. Operating times and their dependency on environmental and operating conditions as well as the prestrike behavior are particular to every type of circuit breaker.

B. Circuit Breaker Characteristics

These are the characteristics of an ideal circuit breaker:

- There is no variation of breaker closing or opening times.
- The dielectric withstand characteristic of the contact gap is infinite during closing as long as the breaker contacts do not touch, and consequently there is no prestriking time.
- The probability of restrike or reignition during an opening operation is zero.

Real circuit breakers, however, exhibit some variation of operating times. Breaker operating times of different types of circuit breakers vary significantly with operating and environmental conditions. Some of the operating time variations are predictable and some are purely statistical. The circuit breaker operating time is expressed as the sum of three terms (5):

$$T_{\text{Oper}} = T_{\text{Nom}} + \Delta T_{\text{Pred}} + \Delta T_{\text{Statistic}} \quad (5)$$

T_{Nom} is the mean operating time under normal operating conditions that can be measured and programmed into the controller. ΔT_{Pred} is a predictable variation of the operating time that can be corrected by the controller. $\Delta T_{\text{Statistic}}$ is a purely statistical variation of the operating time that cannot be corrected by the controller.

The predictable variations of the circuit breaker operating times can be further split into two terms.

$$\Delta T_{\text{Pred}} = \Delta T_{\text{Comp}} + \Delta T_{\text{Drift}} \quad (6)$$

ΔT_{Comp} is an operating time variation for which a predetermined compensation can be applied. ΔT_{Drift} encompasses those variations, such as long-term drift effects, that might be accommodated by adaptive features of the controller.

The controller can compensate for all variations in operating parameters that can be measured in the field by appropriate sensors and transducers and that result in defined changes of circuit breaker operating times. The operating time used by the controller is adjusted based on sensor inputs and according to a known set of operating characteristics, that have been determined under well-defined conditions during testing. The following operating parameters are most often compensated:

- Variation of dc control voltage, V_{Control}
- Circuit breaker stored energy, E_{DR}
- Ambient temperature, θ

$$\Delta T_{\text{Comp}} = f(V_{\text{Control}}, \theta, E_{\text{DR}}) \quad (7)$$

The controller can treat small variations of the dc control voltage and ambient temperature independently in the calculation of circuit breaker compensation time. The same holds true for small variations of ambient temperature and operating pressure, in the case of hydraulic- or pneumatic-operated breakers. Large variations of dc control voltage or operating pressure and ambient temperature require a two-variable function to define the breaker operating times. Therefore, for large variations of operating parameters, the controller could interpolate two-dimensional functions of dc control voltage/temperature and operating pressure/ambient temperature to calculate a compensation time.

The operating time of certain types of circuit breakers may vary, depending on the time the last breaker operation took place. For example, idle time of only several hours can impact the operating time of hydraulic-operated gas circuit breakers and approach a saturated value with idle times longer than 100 hours. Breakers using spring-operated mechanisms and using lubricating chemical coatings instead of grease for the lubrication of breaker sliding parts exhibit almost no variation in operate time in the first 1000 hours since the previous operation [2]. The controller can compensate for idle time by taking into account the time between circuit breaker operations and the circuit breaker idle time characteristics provided by the circuit breaker manufacturer.

Frequency of breaker operations increases the breaker operating time for some types of circuit breakers. Certain

breaker-interrupting chambers use a specially designed absorber rod to channel the energy of a prestrike. Each time a prestrike occurs, the absorber rod becomes shorter. Such circuit breakers display longer operating times as the number of breaker operations increases.

Adaptive control can compensate for this type of variation of breaker operating times. Adaptive control uses previously measured operating times to detect changes in breaker operating characteristics and predict the circuit breaker operating time for the next operation. It compensates for any drift in operating times that persist for a number of consecutive operations because of aging and wear. The effectiveness of adaptive control is enhanced with accurate measurement of past breaker operating times using special travel sensors.

Fig. 3 shows a block diagram of controlled switching.

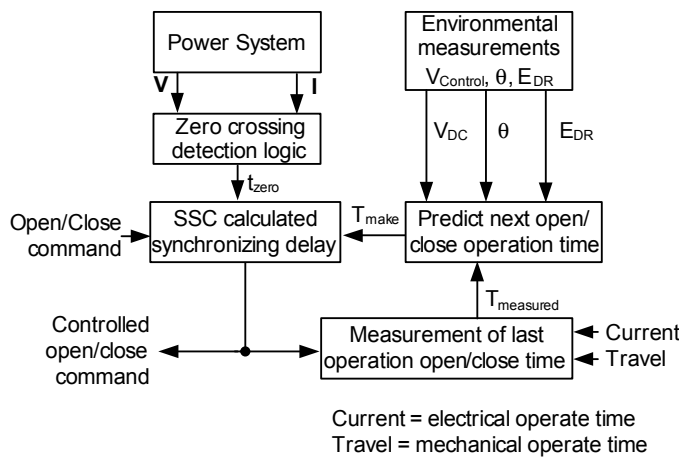

Fig. 3. Block diagram of controlled switching

C. Benefits of Controlled Switching

Controlled switching benefits include circuit breaker performance enhancements, switching transient reduction, equipment maintenance cost reduction, equipment life extension, and power quality improvement.

Controlled switching reduces the magnitude of energization transient currents and the probability of restrike occurrence, and as a result increases the life expectancy of circuit breakers. Improving the conditions during current interruption can enhance circuit breaker performance. Using controlled opening to permit longer arcing times results in greater contact separation after current interruption. Greater contact separation reduces the probability of a restrike, and consequently enhances the circuit breaker performance in the dielectric region.

The benefits of controlled switching are both technical and economical. The technical benefits of controlled switching for reactive loads are as follows:

- System and equipment transients reduction
- Power quality improvement
- Circuit breaker contact burn reduction
- Circuit breaker enhanced performance during current interruption in the dielectric region
- Avoidance of nuisance relay operations

The financial benefits of controlled switching of reactive loads are:

- Increased life expectancy of power system equipment
- Reduced risk of equipment failures
- Elimination of breaker closing resistors and auxiliary chambers, which reduces circuit breaker costs by approximately 25 percent
- Elimination of closing resistor and auxiliary chamber maintenance
- Increased intervals of interrupter maintenance or retrofit

D. Controlled Closing and Current Zero Times

Table I summarizes the optimum controlled closing times for energizing different types of equipment. The symbols Yg and Y refer to grounded and ungrounded wye connections and D refers to delta. Use the Yg-D or Y-D row for a Y-connected transformer without a delta winding but with a three-phase common core. The transformer is energized from the winding listed first. This table assumes an A-B-C counterclockwise rotation, with A-ph (or A and another phase) being energized first. The columns labeled A-ph, B-ph and C-ph show the close angle relative to the A-phase voltage positive-going, zero-crossing.

In Table I the unsymmetrical C-ph closing angle for the transmission line is an average value for a number of line lengths and varies with line design and transposition schemes. This angle reflects the effect of the A-ph voltage that is induced on the C-ph conductors prior to closing. With both A-ph and C-ph closed, the imbalanced effect is cancelled out by the time B-ph closes.

TABLE I
OPTIMUM CLOSING TIMES FOR DIFFERENT EQUIPMENT (IN DEGREES)

Equipment	Configuration	A-Ph	B-Ph	C-Ph
Shunt Capacitor	Yg	0	120	60
	Y	30	120	30
	D	30	120	30
Shunt Reactor	Yg	90	210	150
	Y	60	60	150
	D	60	60	150
Transformer	Yg-Yg	90	210	150
	Yg-D or Yg-Yg-D	90	180	180
	Y-D	60	60	150
	D-D, D-Yg or D-Y	60	60	150
Line	Yg	0	120	54

Fig. 4 and Fig. 5 show two examples of the time staggering sequences of controlled closing of a grounded and an ungrounded shunt capacitor bank.

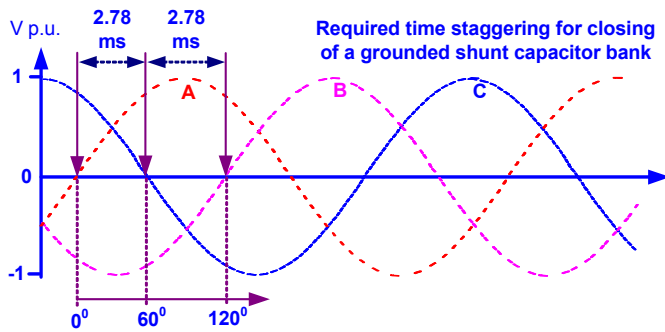

Fig. 4. Controlled closing sequence (A-C-B) for a grounded shunt capacitor bank in a 60 Hz system

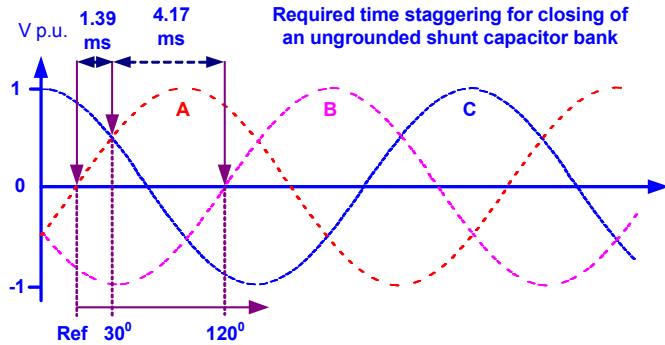

Fig. 5. Controlled closing sequence (A & C, B) for an ungrounded shunt capacitor bank in a 60 Hz system

When a breaker opens to de-energize equipment, it interrupts current at natural current zeros determined by the configuration of the equipment, unless the breaker produces current chopping, which would modify these natural current zeros. Modern SF6 breakers have a relatively low arc voltage and do not tend to significantly chop current. As stated above, controlled opening will cause the breaker contacts to part at the proper time relative to these natural current zeros to limit reignitions and restrikes. Table II lists natural current zero timing while de-energizing different types of equipment, with the various configurations as used in Table I. The transformer is de-energized from the winding listed first. The columns labeled A-ph, B-ph, and C-ph show the phase angle of the current zeros relative to the A-phase voltage positive-going zero-crossing.

TABLE II
CURRENT ZERO TIMES FOR DE-ENERGIZING DIFFERENT EQUIPMENT (IN DEGREES)

Equipment	Configuration	A-Ph	B-Ph	C-Ph
Shunt Capacitor	Yg	90	210	150
	Y	90	180	180
	D	90	180	180
Shunt Reactor	Yg	90	210	150
	Y	90	180	180
	D	90	180	180
Transformer	Yg-Yg	90	210	150
	Yg-D or Yg-Yg-D	90	210	120

Equipment	Configuration	A-Ph	B-Ph	C-Ph
	Y-D	90	180	180
	D-D, D-Yg or D-Y	90	180	180
Line	Yg	90	210	158

III. CONTROLLED SWITCHING REQUIREMENTS

The sections below discuss details of controlled switching for various equipment and configurations, including applications of these methods by Bonneville Power Administration (BPA). BPA has applied controlled switching to reduce equipment stress and reduce disturbances to the power system. Today, nearly every new 500 kV breaker and nearly every 500 kV breaker involved in relay replacements will have controlled closing and possibly controlled opening. Although BPA now has extensive applications of controlled switching, system equipment is generally still designed and specified to withstand worst-case transients, without reliance on controlled switching for survival.

A. Shunt Capacitor Bank Switching

Shunt capacitors are probably the most commonly switched devices on power systems. To deliver reasonably constant voltage, shunt capacitors can be switched in and out multiple times per day. Each operation usually results in the bus voltage dropping close to zero on one or more phases and then overshooting normal voltage as it recovers. The rapid voltage collapse and recovery and corresponding transient current sends surges out on all lines connected to the bus. These voltage transients create phase-to-ground and phase-to-phase overvoltages at remote locations, particularly on the ends of lines terminated with transformers. The voltage transients can also create problems from amplification by shunt capacitors on nearby low-voltage networks and are a typical source of problems for sensitive loads. When back-to-back switching occurs with other capacitors on the same bus, the banks exchange large transient currents that are inherently undesirable, particularly because of induced voltages in low-voltage cables and step-and-touch potentials.

Controlled closing can mitigate the voltage and current transients from shunt capacitor energization. For a grounded shunt capacitor, each phase is independent and the breaker can target the bus voltage zeros to eliminate voltage and current transients. Successfully closing at a voltage zero is difficult for a breaker, requiring a breaker with consistent closing times and a steep rate of decay of dielectric strength (RDDS). The RDDS is the slope of the voltage-time characteristic at which the contacts will prestrike prior to metal-to-metal contact. The three phases may be closed at 60-degree intervals (e.g., A-C-B) to accomplish this. Ideally, there is no prestrike and the current into the shunt capacitor begins just as the breaker contacts meet metal-to-metal.

As difficult as it is to hit voltage zeros for shunt capacitor switching, BPA has been successfully applying controlled closing on its EHV shunt capacitors since 1997. For each new bank or breaker replacement at 500 kV, a dead-tank SF6 breaker is used with controlled closing. For certain 230 kV

applications where reduction of transients is deemed important, a dead-tank breaker with independent pole mechanisms has been applied with controlled closing. The breaker controllers have a learning feature that adjusts timing for the next close operation based on the error measured during the previous close operation. The controlled breakers at BPA have generally been successful in closing at voltage zeros within the specified ± 0.5 ms.

Fig. 6 shows BPA field test measurements for the bus voltage and current on one phase during random energization of a single shunt capacitor bank. Note how the energization near voltage peak creates the large initial current spike compared to the steady-state capacitor current, along with an overvoltage. Fig. 7 shows the voltage and current measurements for the same shunt capacitor during a controlled energization near a voltage zero. Note how the initial current transient is close to the steady-state peak current and the overvoltage is gone.

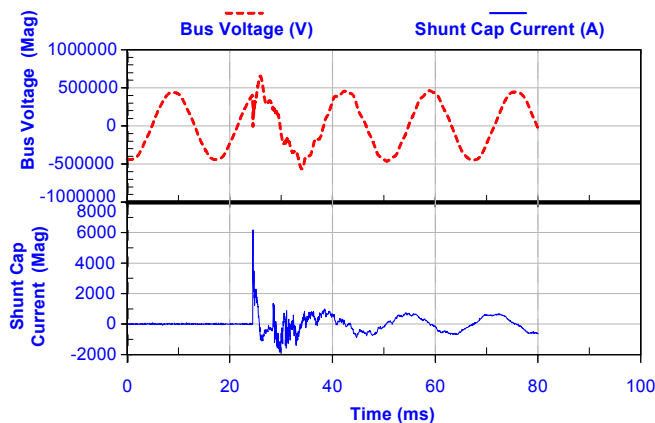

Fig. 6. Uncontrolled shunt capacitor bank energization

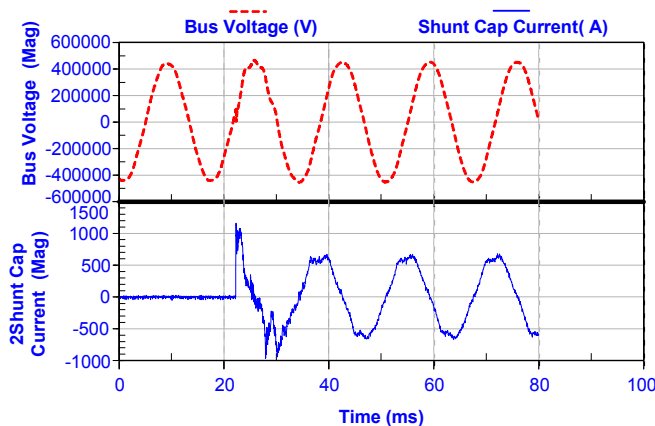

Fig. 7. Controlled grounded shunt capacitor bank energization

Fig. 8 shows a BPA field test measurement of an uncontrolled back-to-back shunt capacitor energization near a voltage peak and the resulting very large currents with respect to the steady-state value. Fig. 9 shows measurements for the same shunt capacitor under controlled closing and the relatively small current and voltage transients.

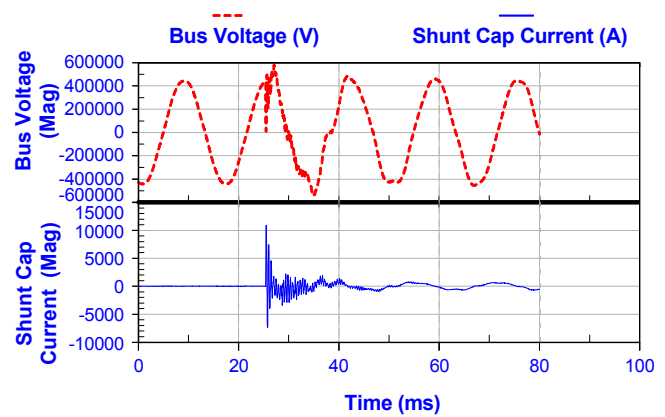

Fig. 8. Uncontrolled back-to-back shunt capacitor switching

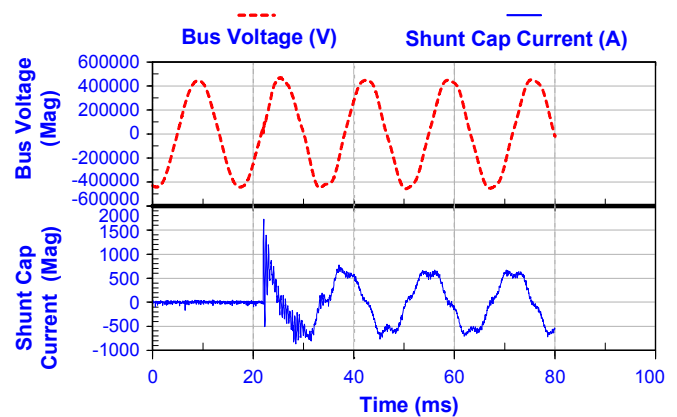

Fig. 9. Controlled back-to-back shunt capacitor switching

Controlled closing at 230 kV has been applied selectively at BPA because the special independent pole breaker increases the cost of the installation. Controlled closing at 230 kV has been used to reduce back-to-back currents for shunt capacitors located at different parts of a substation, to provide improved power quality for station service to a nuclear plant, and to prevent remote overvoltages in locations where all lines emanating from the substation were terminated in transformers. On BPA's 500 kV system, seven of 22 shunt capacitor banks use controlled closing, while eight out of 78 banks use it at 230 kV. All of BPA's 500 and 230 kV shunt capacitor banks are solidly grounded. BPA has no experience to date with controlled closing for ungrounded banks.

Because of the frequency of switching, shunt capacitor de-energization is a common source of breaker and circuit switcher failures during opening. These failures usually take the form of restrikes, or multiple restrikes, until a backup device isolates the breaker or circuit switcher. Multiple restrikes can cause surge arresters and other equipment to fail because of their severity.

Shunt capacitor opening starts out as very easy duty for a breaker. The current is small and the slope of the recovery voltage is very low. Thus the arc in a breaker can be extinguished very soon after the contacts part. However, with one per unit (p. u.) trapped charge left on the bank, the recovery voltage across the breaker becomes 2 p. u. in one-half cycle. If the contacts are not sufficiently far apart because of the early current clearing, then there is a chance for a

restrike. As described previously, controlled opening modifies the timing of the contacts to ensure that they are far apart when the peak recovery voltage occurs. Because controlled opening is only recently available, BPA has yet to apply controlled opening to shunt capacitor switching.

B. Shunt Reactor Switching

With gapped cores and rather linear saturation characteristics, shunt reactors do not create the very large, harmonic-rich inrush currents caused by transformers. This implies that they would be easy devices to switch in and out. Experience, however, has shown that both energizing and de-energizing of shunt reactors can be quite problematic. When shunt reactors are not energized at a voltage peak, an offset sinusoidal current with some distortion from saturation characterizes the inrush. With the low-loss characteristics of shunt reactors, this dc offset current decays slowly over a second or so and can cause local transformer saturation. This phenomenon has been particularly amplified when the other paths from the substation have series capacitors that block the dc current, leaving a local transformer as the only remaining path.

At BPA, the dc offset from reactor energization has created and contributed to a number of system problems and disturbances. In 1992, a 500 kV reactor energization on the AC Intertie caused a local generator to trip off because of transformer and generator saturation. During a disturbance on the Montana Intertie in 1994, a 500 kV reactor energization caused transformer saturation and led to 230 kV line trip-outs caused by relay misoperations from excessive harmonics. In both of these cases, all 500 kV lines leaving the stations were series-compensated. These problems and similar less dramatic events led BPA to immediately begin work on controlled closing for shunt reactors.

To eliminate the dc offset of shunt reactor energization, each phase must be energized at a voltage peak. Older circuit switchers energized shunt reactors in air with slowly closing contacts and therefore always energized at voltage peaks. With the fast contacts and high dielectric strength of SF6 breakers, the point on the voltage wave where the reactor is energized is random, where one or more phases will tend to have significant dc offset currents. Energizing at voltage peaks is easy for a controlled closing device since the target area at the top of the sine wave is large. The contacts will prestrike to start current flow into the reactor 2 ms or more before the contacts actually meet.

Fig. 10 and Fig. 11 show BPA field test measurements of one phase during both uncontrolled and controlled shunt reactor energization. The waveforms include the bus voltage, reactor voltage, reactor current, and measured breaker contact travel. This field test included contact travel measurements because the objective was to carefully test both controlled closing and opening. In Fig. 10, current is initiated at a bus voltage zero, resulting in an offset, slightly distorted, reactor current. In Fig. 11, the shunt reactor is energized at a voltage peak, which results in the desired symmetrical reactor current without dc offset.

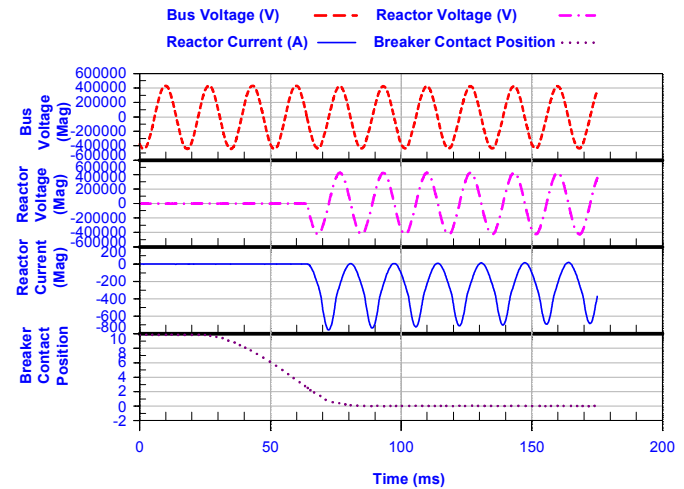

Fig. 10. Uncontrolled shunt reactor energization

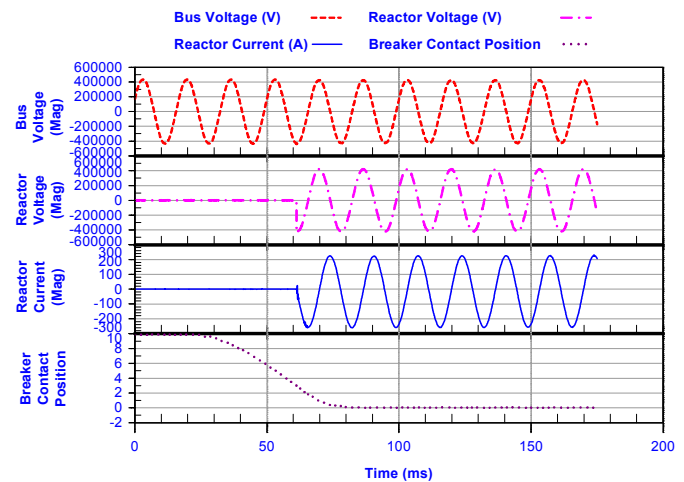

Fig. 11. Controlled shunt reactor energization

BPA's 500 kV system has 26 shunt reactors, many of which are switched daily. Of those reactors, 17 are switched with breakers and each of these breakers employs controlled closing. Of BPA's seven 230 kV shunt reactors, one uses controlled closing.

Reactor de-energization has been more problematic for BPA than energization. The capacitance of the bus between the breaker and the reactor causes a high frequency ring down of the trapped charge on that capacitance, typically about 1500 Hz. At this frequency there is a steep rise in recovery voltage across the breaker, reaching 2 p. u. in about 0.3 ms. The result is often reignitions of one or more phases during each de-energization.

Multiple reignitions on phases have led to a number of breaker failures during reactor de-energization on the BPA system. One solution to these failures has been to apply external arresters across the breaker contacts, supplied by the breaker manufacturer. Another manufacturer's solution was to apply the recently developed controlled opening for all reactor-switching breakers. Today at BPA all new reactor-switching breakers are required to have controlled opening to keep the breaker warranty valid. BPA now has 12 shunt reactors that employ controlled opening, which was first

implemented in 2004. The control appears successful to this point in preventing breaker failures. Controlled opening with reactors works as described previously, where the contacts are as far apart as practical so they can withstand the high-frequency recovery voltage from reactor de-energization.

Fig. 12 and Fig. 13 show the field test measurements of uncontrolled and controlled reactor de-energization for the same reactor as in Fig. 10 and Fig. 11. The two figures appear nearly the same, except for the reignition on the reactor voltage one half cycle before the final current zero. In the event depicted in Fig. 13, the breaker contact timing is controlled to avoid these typical reignitions that can lead to breaker failures.

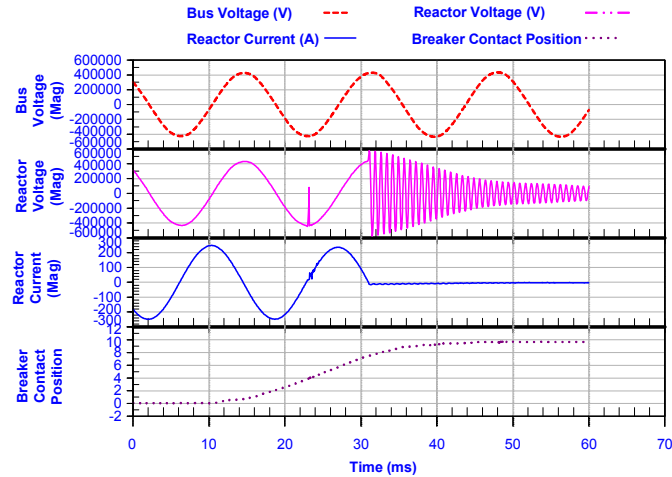

Fig. 12. Uncontrolled shunt reactor de-energization

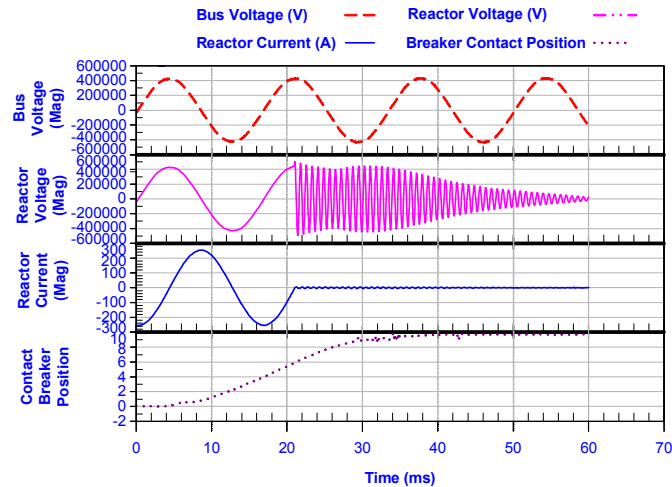

Fig. 13. Controlled shunt reactor de-energization

C. Transformer Switching

It is fortunate that most transformers are not energized and de-energized on a regular basis. If energized with a standard breaker, one or more transformer phases experience very large, prolonged currents caused by half-cycle saturation of the magnetic core. It is not clear that these inrush currents actually damage a transformer. It is also not clear that they do not, particularly as a transformer ages. It seems reasonable that the large magnetic forces involved with peak currents of thousands of amps eventually help break down weak spots in

the transformer insulation after many inrush events. A secondary impact of large inrush currents is partial saturation of other local transformers; this is called “sympathetic inrush” and can create a minor disturbance itself. Because large transformers have become very expensive and a transformer outage can be a critical system loss in heavy load periods, a prudent step to possibly help prolong transformer life is applying controlled closing where practical.

Fig. 14 shows an uncontrolled 1300 MVA, 500/230 kV transformer energization from the 230 kV side. Note the very large half-cycle saturation current with peaks near 3000 A that decay very slowly over many cycles. The high currents contrast with the typical magnetization current that has peaks of less than ten amperes. Controlled closing of this same transformer from the 230 kV side typically involves peak currents less than one percent of the peaks in Fig. 14. For this transformer, closing normally is done from the 500 kV side.

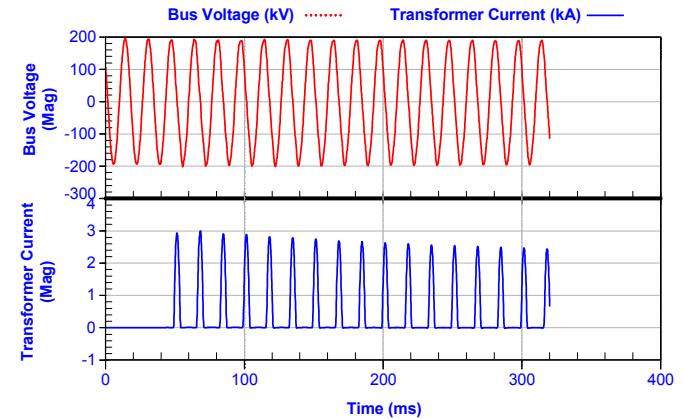

Fig. 14. Uncontrolled transformer energization

If one ignores residual flux, then energizing a transformer bank that is made up of single-phase units without a tertiary winding is a simple task. Because the phases are not coupled, the breaker just needs to hit the bus voltage peaks, the same as for shunt reactor energization. This will make the core flux symmetrical and virtually eliminate inrush.

If the transformer has a tertiary winding or is constructed with a three-phase core, then there is direct magnetic coupling between the phases. Energizing the first phase creates a voltage and corresponding flux in cores of the remaining phases. If one again ignores residual flux, controlled closing timing for this kind of transformer is to energize the first phase on a voltage peak. This makes the flux in the first phase symmetrical and induces voltages on the remaining phases in the opposite polarity. The remaining two phases must be simultaneously energized 90 electrical degrees after the first phase, or later in one-half-cycle increments thereafter (e.g., 270 degrees). This is the point where the core flux that was created by the first phase is equal to the “prospective” core flux from the bus voltage of the remaining two phases. Even though the points that must be targeted on the last two phases to close are not on bus voltage peaks, the points actually correspond to voltage peaks across the breaker caused by the induced voltage from the first phase. Thus, this controlled closing is relatively easy to accomplish.

When a breaker interrupts the magnetizing current in a transformer, a significant level of residual flux is typically left in the magnetic core because of hysteresis characteristics. If the transformer is reenergized at the worst polarity, the applied voltage can create flux that immediately sends the core deep into saturation, resulting in the highest inrush currents. With controlled closing that does not account for the residual flux, the transformer will still experience saturation, although the level of the saturation will be reduced. There has been substantial recent research in developing controllers that can predict residual flux and adjust breaker timing to minimize inrush. Some controllers are now available that predict residual flux and adjust breaker closing times.

In 2000, BPA performed a field test on a 500/230 kV transformer to develop a controller that could predict residual flux. A phenomenon measured during that field test greatly enhanced and simplified controlled closing on transformers at BPA. BPA found that while the 500 kV breaker is open with the bus voltage on one side and the de-energized transformer on the other, a low-level ac voltage is applied to the transformer through the grading capacitors across the multiple contacts (typically 2) of the breaker. Over the minutes that this low-level ac voltage appears on the transformer prior to closing the breaker, that voltage slowly reduces the residual flux in the transformer to lower levels. This phenomenon was measured and confirmed in the field test. Although the process takes many cycles, in practical switching scenarios there are usually many minutes before the transformer is energized. Typical 500 kV transformer installations will often have two or more open breakers that can provide this low-level energization. Although there is no guarantee that most of the residual flux on a 500 kV transformer will be removed for all possible configurations, this phenomenon appeared to happen for each of the controlled closing applications on 500 kV transformers at BPA.

The self-reducing residual flux phenomenon in transformers energized by breakers with grading capacitors is one of those rare, lucky outcomes for controlled closing, at least at 500 kV. At BPA, all controlled closing applied on 500 kV transformers assumes no residual flux, with timing as described above. At lower voltages, however, the 230 and 115 kV breakers at BPA typically have a single set of contacts with no grading capacitors, and thus do not modify the residual flux. Therefore, successful controlled closing at these lower voltages not only requires more expensive breakers with individual phase capability, but smart devices that can successfully predict the transformer's residual flux and adjust timing appropriately.

BPA started successfully applying controlled closing on transformers nearly ten years ago. Of the 35 transformers at 500 kV, twelve now have breakers using controlled closing. All of BPA's 500 kV transformers have separate tanks for each phase with typical bank ratings from 900 to 1300 MVA. BPA has not yet applied controlled closing to transformers below 500 kV.

D. Transmission Line Switching

A primary factor in the design of EHV lines is the expected level of switching surges. In the future, the ability to limit switching surges to lower levels with controlled closing may provide some significant cost benefits. For typical transmission lines, the most severe switching surges are the result of clearing a fault, followed by a three-phase, high-speed reclose with trapped charges on the unfaulted phases. Lines that are not high-speed reclosed, have transformer terminations, have magnetic voltage transformers, or use normal single-pole switching, will typically not have trapped charges and consequently will not have severe switching surges.

Historically, EHV breakers have used closing resistors to control switching surges. However, for the past 20 years, BPA has been installing mostly resistorless breakers on the 500 kV system, although some breakers with closing resistors are still applied for special situations. At this time, approximately 80 percent of the 500 kV breakers are resistorless. Switching surge control is accomplished by installing surge arresters at the other end of the line and by stagger closing the resistorless breaker. In staggered closing, each phase of the breaker is closed about a cycle apart, generally A-B-C. This stagger reduces overvoltages by preventing interaction among the phases where switching surges on one phase induce additional surges at the wrong time on another phase. These additional induced surges create the highest overvoltages in normal, simultaneous, three-phase reclosing.

Reducing switching surges with controlled closing requires a controller that can determine the state of the voltage on the line and adjust the breaker timing to compensate. Like predicting residual flux in transformers, determining the voltage on a transmission line is not a simple task. If there is no charge on the line, it is clear that closing control can target bus voltage zeros. But for high-speed reclosing, breakers at either end of a line can be the last to clear, leaving trapped charge on the line. The secondary output of capacitive voltage transformers (CVTs) becomes distorted and decays rapidly to zero following the loss of 60 Hz voltage. Thus, the first breaker to reclose requires a sophisticated controller to determine which phases have a trapped charge and what those polarities are. If the line has one or more shunt reactors, the line voltage will oscillate at the reactor-line natural frequency during the dead time prior to reclose. Properly timing the breaker so the bus and line voltage are as close as possible when the contacts touch requires sophisticated logic because the line voltage is constantly changing. BPA has not yet applied a sophisticated controller for high-speed reclosing with trapped charge or line reactors. BPA's future plans are to incorporate trapped charge logic for high-speed reclosing.

One would usually assume that the priority in all controlled transmission line switching is to reduce switching surges. This reduction is an excellent goal where it is practical, but there can be another, even better reason to control how a breaker energizes certain lines: when the line is terminated in a transformer. Controlling transformer inrush is a high priority for controlled closing, at least at BPA. However, a breaker

that is controlled to minimize inrush on a line-connected transformer would tend to be energizing near voltage peaks, which is generally the wrong point at which to control switching surges. Fortunately, a transformer connected to the line will both eliminate the trapped charge on the line and also supply a surge arrester. These features combine to make switching surges much less of an issue. Thus, when lines have transformer terminations, controlled closing can be used to reduce transformer inrush without a detrimental effect on switching surge control.

When using controlled closing on lines to reduce transformer inrush, residual flux must again be considered. The grading capacitors across the open breaker have no impact on the line voltage, because the line capacitance is large, so there is no residual flux reduction from the open breaker. When a line with a transformer is de-energized, a grounded transformer typically rings down the trapped charge on the line to zero. The dc voltage of the trapped charge drives the transformer core into saturation and then the line discharges through the transformer and recharges in the opposite polarity. The new dc voltage on the line will be lower because of the energy lost in the discharge. The new dc voltage will saturate the transformer core, although this takes longer with a lower voltage. These events will continue as a decaying series of discharges that finally removes virtually all of the trapped charge. It may seem that these discharges might leave the transformer with a high level of residual flux. However, a 1980 BPA field test to measure the residual flux in a transformer from line discharges showed the maximum residual flux to consistently be 30 percent or less. Therefore, like normal bus transformer switching at 500 kV, BPA assumes the residual flux is zero for controlled closing on transformer-terminated lines.

BPA now has four 500 kV, transformer-terminated lines that use controlled closing to reduce transformer inrush. Two of these transformers have tertiary windings and two do not. The timing for each case is different than for bus transformers for two reasons. First, the influence of the capacitive coupling between the phases along the transmission line affects the proper timing for the controlled close. Secondly, because this is a transmission line, the breaker uses staggered closing, so each phase is timed at the proper point on the voltage wave, but about a cycle apart. Prior to implementation, BPA normally confirms the proper timing for each transformer-terminated line application using EMTP simulation.

E. Circuit Breaker Requirements

The most obvious requirement for controlled switching is a breaker that can be controlled on each phase. At the EHV level, breakers have individual phases and independent operating mechanisms. This makes the application of controlled switching rather inexpensive, involving only the cost of the controller and the wiring. At lower voltages, economical breakers generally have a single operating mechanism, so independent phase control is not possible. Thus, controlled switching at lower voltages usually requires a new breaker with independent phases at additional cost. At

BPA, certain lower-voltage applications for new breakers were selected where minimizing the disturbance was worth the additional cost. These have been 230 kV shunt capacitor and shunt reactor circuit switching applications.

For switching at lower voltages, it is certainly possible to use a breaker or circuit switcher with a single operating mechanism but with a built-in, adjustable, mechanical stagger in the timing of the contacts. A controller would time the lead phase to close or open and the other phases would follow at constant intervals. For most applications this would work well, because the desired timing among the phases does not really change. Such a breaker or circuit switcher could be very cost effective, probably making such a device the industry choice for switching. A few of these types of breakers and switchers have been introduced for some limited controlled closing applications.

After the ability to control each phase, the most important feature of a breaker for successful controlled switching is repeatability, where consistent closing and opening times allow accurate timing without frequent recalibration. Many modern SF6 breakers are capable of consistent operation and are therefore appropriate for controlled switching. Another important breaker feature is the RDDS during closing. When a breaker or circuit switcher is used to control closing of shunt capacitors, its RDDS must be steeper than the maximum slope of the bus voltage. For 550 kV at 60 Hz, this maximum slope is $V_p \cdot \omega = (449 \text{ kV})(377/\text{s}) = 169 \text{ kV/ms}$, and for 241.5 kV the slope is 74 kV/ms. A steeper RDDS slope than these minimums is better for successful voltage zero control. For switching shunt reactors and most transformers, the target is to hit near voltage peaks, so a breaker or circuit switcher can be less precise and the RDDS slope can be lower than that for shunt capacitors.

BPA has switched from using large numbers of live tank breakers to dead tank breakers; therefore, controlled switching is becoming more common on dead tank breakers. Since tank heaters can be installed on dead tank breakers, BPA's current practice is to use tank heaters in the colder areas and not use temperature compensation in the controller. This is not an option for live tank breakers.

F. Adaptive Controller Functions

Like most areas of technology, the relays or control devices for controlled switching started out as simple devices and have become more sophisticated and "smart" with additional development and experience. The most basic controller uses bus voltages to consistently apply a close or open command at a particular point on the waveform. It is up to the user to recognize any problems and readjust timing to compensate appropriately. A controlled opening device uses breaker current to properly time the contact parting. More elaborate controllers measure variables such as temperature, dc voltage, hydraulic pressure, and even idle time to modify the control command. The impact of each variable and its most probable effect on operation would have to be quantified, although these effects are often estimations or could be provided by the circuit breaker manufacturer.

A more sophisticated controller should be capable of having multiple settings. This is very useful where the breaker should perform differently, depending on the circumstances. For example, in a ring bus or breaker-and-a-half scheme, where the same breaker switches a transformer and a line, the breaker could be energizing the transformer, energizing the line, picking up load, or just paralleling back in with already energized equipment. A controller capable of changing its timing and/or functions to the appropriate need is quite valuable. So far, BPA has applied controlled closing in this situation on ten breakers.

Controllers that quickly adapt to recent electrical measurements on the equipment being switched would be even better. One example is a controller that could reliably determine the trapped charge on a line and the proper timing changes for its breaker. Another example is a controller that could measure the ringing frequency of a line with shunt reactors and then time the breaker to reduce reactor inrush and even possibly switching surges. A controller might even be able to predict the residual flux in a transformer from electrical measurements, providing reliable timing points to minimize transformer inrush.

Controllers with the abilities described above would all be open-loop devices, where a point in time is selected to operate a breaker or circuit switcher without feedback. A closed-loop feature, referred to as learning ability, would be a further enhancement. With this feature, an error signal is created based on the actual time of operation compared to the intended time. This error signal is used to adjust timing for the next operation. Such a feature is beneficial for difficult controlled closing tasks such as shunt capacitor switching.

The ultimate controller would take this learning ability to the next level: learning over time. Every operation of its breaker or circuit switcher within certain operational bounds would be another data point in an advanced learning algorithm, where the controller better accommodates the peculiar characteristics of its own breaker. The timing of an operation would be modified not only by the error in the previous event, but by the temperatures, pressures, idle time, and so forth; by the dependency between these variables; and by what the controller has learned about the breaker response to these variables. Thus, the controller can help create a characteristic for its breaker that could be used as a reference point for similar breakers. A few controllers that are currently available are capable of performing many of the functions described above.

G. Impact of Substation Configuration

In a breaker-and-a-half or ring bus configuration, a breaker may be called upon to switch two different types of equipment. These could be a line, a transformer, a transformer-terminated line, etc. Fig. 15 shows a breaker-and-a-half bus configuration where Breaker B is required to switch either a transmission line or a transformer. This requires an adaptable controller for this breaker that is able to sense the conditions and apply the proper switching sequence timing. In the scenario shown in Fig. 15, Breaker B must be able to

apply different switching sequences for the line and for the transformer, or two different controllers may be required to effectively switch the two different types of equipment.

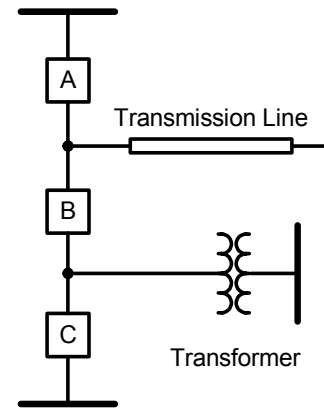

Fig. 15. Breaker-and-a-half bus configuration with a transformer and a line

Most of the 500 kV lines in the BPA system use single-pole tripping in contrast with lower voltage systems where almost all the lines use three pole tripping. Therefore, all 500 kV breakers have single-pole capability but most of the lower voltage breakers do not. Because of this practicality, BPA has explored the benefits of controlled closing and controlled opening mainly on the 500 kV system.

At BPA, the breakers that are being configured for controlled switching are either dedicated to the equipment to be switched, or they are arranged in a breaker-and-a-half bus or a ring bus configuration. Therefore, substation configuration dictates the operating requirements of the breaker and the controlled switching equipment

Shunt capacitors and shunt reactors have dedicated circuit breakers. For these installations, the controlled switching equipment need only be set for that particular application. As described previously, shunt capacitors are closed near voltage zeros and shunt reactors are closed near voltage peaks. Controlled opening is also used on shunt reactors to reduce breaker re-ignitions.

Transformers and transmission lines are most commonly terminated in substations that are either configured in a breaker-and-a-half or a ring bus arrangement, and the circuit breakers are not dedicated to only one specific function. Transmission lines, transformers, and buses in the 500 kV system require opening of two or more circuit breakers to clear the local terminal. Transmission lines can be energized from an adjacent breaker or from the remote terminal, and transformers can be energized from an adjacent breaker or from the low voltage side. The control logic for one of these circuit breakers must detect the system condition of the breaker before sending it a close command, in order to apply the correct close control logic. Tripping control logic is not as much of a problem because the requirements generally do not vary between applications.

Consider, for example, a circuit breaker in a ring bus that has an autotransformer with no tertiary winding on one side and a transmission line on the other side. As described above, BPA uses resistorless breakers for most applications, with

staggered pole closing on transmission lines and metal oxide surge arrestors at the line terminals. An open transmission line is normally capacitive to the first breaker to close and the poles should close near voltage zeros, when there is no trapped charge. Therefore, the controlled closing device is set to close the breaker poles at voltage zeros with B-phase delayed one cycle after A-phase, and C-phase delayed two cycles when the breaker is energizing a transmission line. The transformer with no tertiary winding needs to be closed near voltage peaks. Because of the ring bus configuration the controller must control closing in one of the following four states:

1. The breaker could have voltage on both sides if the line and the transformer are already energized from adjacent breakers, the low voltage side, or the remote terminal. The controller must either close the breaker unconditionally or close it via synchronization checking elements.
2. If the transformer is de-energized and the line is energized, the controller must close the breaker poles near voltage peaks.
3. If the transformer is energized and the transmission line is de-energized, the controller must close the breaker poles near voltage zeros with a one-cycle pole stagger on B-phase and two cycles of pole stagger on C-phase.
4. If both sides of the breaker are de-energized, such as during maintenance, the controller must close the breaker unconditionally.

IV. FIELD EXPERIENCES

This section presents controlled switching field application examples that illustrate how BPA is using this technology to reduce switching transients, extend equipment life, and provide better quality of service to its customers.

A. Examples of Controlled Switching

1) Controlled Closing of Shunt Reactors

Controlled closing was added to the circuit breakers on three 550 kV, 225 Mvar shunt reactors at a 500 kV substation. The reactors are located on the two 500 kV buses and are used for voltage control. This substation has one 525/241/34.5 kV autotransformer and four long series-compensated lines.

The dc offset that quite often occurred during uncontrolled energization of the shunt reactors caused disturbances in the local 230 kV system. Sometimes these 500 kV switching events were severe enough to trigger a digital fault recorder in a 230 kV substation 30 miles away. The 500 kV system was relatively unaffected because all the transmission lines terminated at this substation are series-compensated. Controlled closing was implemented to reduce or eliminate the disturbances in the local 230 kV system during reactor switching at the 500 kV substation. The automatic voltage control function, which was installed previously with older voltage control equipment, is programmed into the new controllers, along with the point-on-wave close control logic.

The shunt reactor breakers are older live tank SF6 breakers and were not initially purchased with controlled closing

equipment. A controller was added for each breaker in the relay control house. The breaker control mechanisms required some modifications of the close circuits to incorporate controlled closing. Close signals from the controller must directly energize the breaker closing coils to provide the greatest accuracy. Since the directly applied close signals bypass the anti-pump scheme in the breaker control cabinet, anti-pumping is added as part of the control close logic in the controller. Also the winter temperature at this station can drop well below zero, so temperature compensation was included in the controls for these three breakers.

With these older breakers, some variations in closing times were expected, and testing verified this. The breaker mechanisms have since been updated and now have more consistent close times.

The close times for the poles were set such that the prestrike occurs near a voltage peak. The bus voltages were the reference for the internal zero crossing detectors and peak detectors. Precision timers align the breaker pole closing times to the exact multiple of a cycle, such that the contact closes near the desired target, which in this case is a voltage peak. When closing near a voltage peak, the main contacts approach each other with a corresponding reduction in dielectric strength across them as the voltage approaches its peak value. The poles will then prestrike one or two milliseconds before the contacts touch mechanically. This prestrike time must be accounted for and added to the close control timers. Fig. 16 and Fig. 17 illustrate a shunt reactor energization test at this substation. The controller closing timers were set to their initial values. Current conduction occurred 2 to 3 ms prior to the bus voltage peak.

Fig. 18 and Fig. 19 illustrate a subsequent shunt reactor energization test after an adjustment of the close control timers. During this test, the breaker poles start conducting less than 0.8 ms before the peak of the bus voltage, reducing the dc offset current substantially.

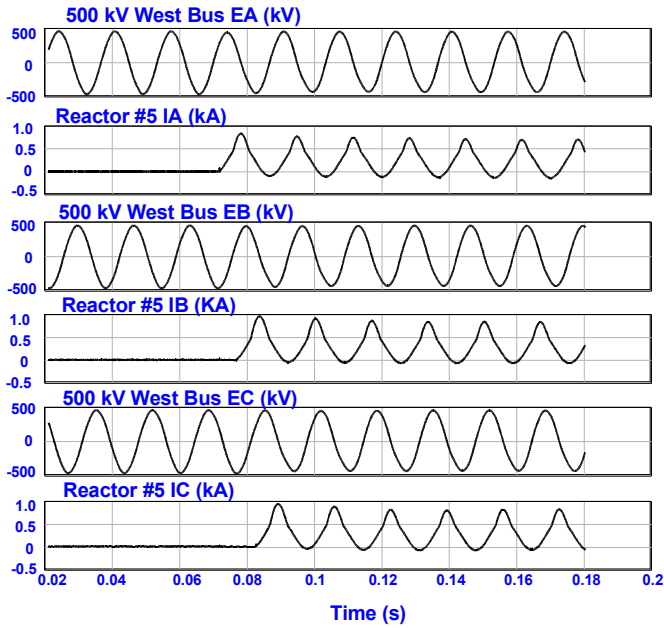

Fig. 16. Shunt reactor close test with controller timers set to their initial values

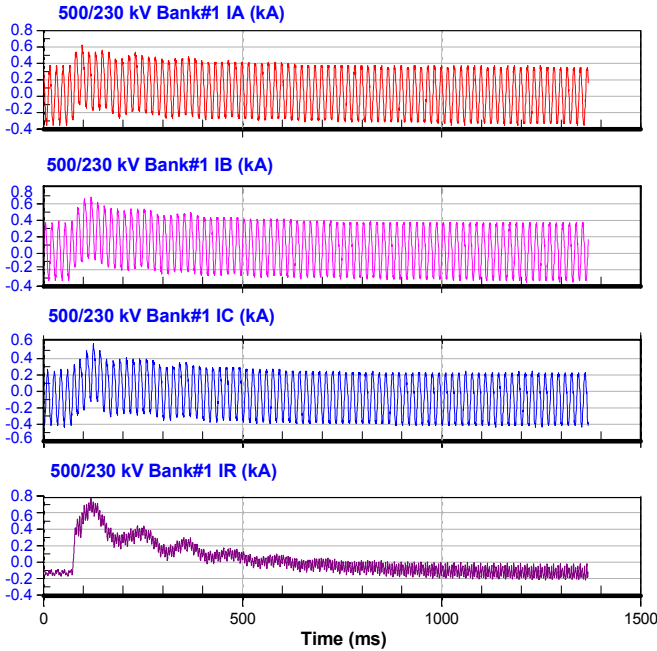

Fig. 17. 500 kV TB #1 phase and neutral currents during reactor close test

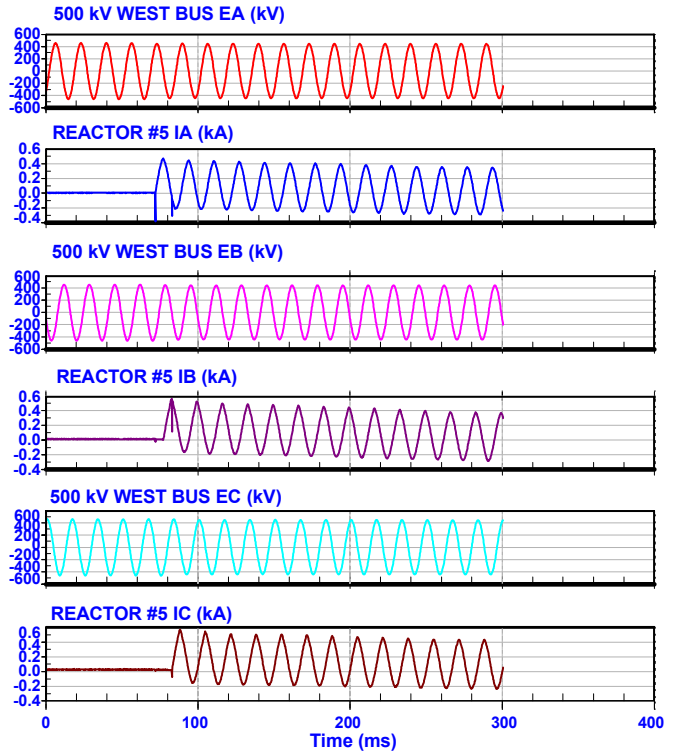

Fig. 18. Shunt reactor closing after adjustment of controller closing times

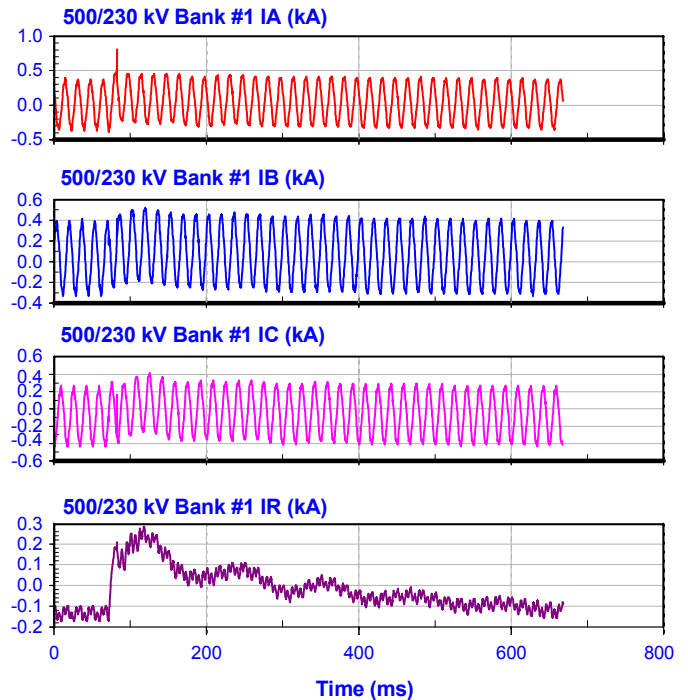

Fig. 19. TB #1 phase and neutral currents after adjustment of closing times

2) *Switching of a 500 kV Transformer Terminated Line*

Controlled closing was added to a 16-mile 500 kV line that terminates in an 1800 MVA, 525/241/34.5 kV autotransformer. The 34.5 kV tertiary winding is connected in a delta configuration.

Uncontrolled switching of this line causes severe transformer inrush, stressing the autotransformer and also affecting the line protection. For example, the switch-onto-

fault logic in one of the static line relays was disabled to prevent occasional false tripping when the line is energized.

This substation is configured as a breaker-and-a-half arrangement with two breakers at the local line terminal. Controlled closing and tripping were added to both line breakers.

The controlled close settings for these controllers are based on the distributed shunt capacitance of the transmission line, the shunt inductive reactance of the transformer, and the delta connection of the transformer tertiary windings. Studies indicated that the optimal settings for the close targets are as follows: close A-phase 80 degrees after a voltage zero, and then close B-phase and C-phase 50 degrees after their respective voltage zero crossings, with an additional 1 cycle delay added to B phase and an additional 2 cycles delay added to C-phase.

The controller trip timers were set to issue trip commands to the individual poles to ensure that actual breaker contact parting occurs just after the current zero crossings (approximately 20 degrees). This allows maximum contact separation when current interruption occurs at the next current zero. BPA uses point-on-wave tripping for manual (SCADA and local) opening of the circuit breakers only. Protective relay operations trip the breakers directly with no point-on-wave supervision.

Fig. 20 shows a controlled closing event to illustrate the reduction of autotransformer inrush currents. The controller close timers were set to the proper preset values, which matched very closely the breaker operating times. The result was a considerable reduction in the transformer inrush current.

Fig. 21 shows a controlled de-energization of the same transformer terminated line.

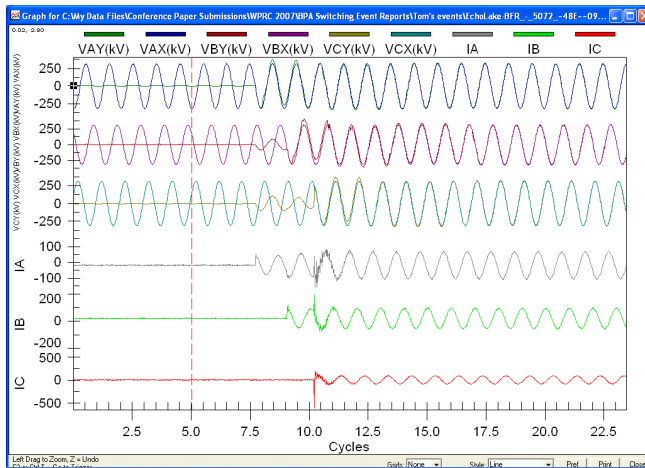

Fig. 20. Controlled transformer terminated line energization reduces transformer inrush current.

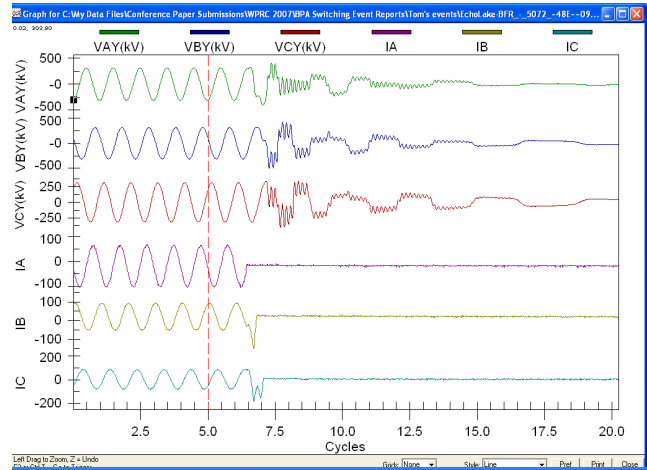

Fig 21. Controlled opening of transformer terminated line

3) Controlled Switching of a 500 kV Transformer

Controlled closing was added to one of the 500 kV breakers to reduce the inrush current of a 1008 MVA, 525/241/34.5 kV autotransformer during a relay upgrade project at a 500 kV substation. The 34.5 kV transformer tertiary windings are connected in a delta configuration.

The breaker is part of a ring bus configuration with the power transformer on one side and a 42.35 mile line on the other side. The controller is set to close in one of four ways:

- Via the synchronization check elements when both sides of the breaker are energized
- Unconditionally if both sides are de-energized
- With the transformer settings when the line side is energized and the transformer side is de-energized
- With the line settings when the transformer side is energized and the line side is de-energized

Controlled tripping is also enabled.

The close control settings are as follows. When closing into the transmission line, the breaker poles are closed near voltage zeros, with B-phase staggered one additional cycle, and C-phase staggered an additional two cycles. When closing into the transformer, A-phase is closed near its voltage peak. Because the tertiary winding couples B-phase and C-phase to A-phase, they are also energized when A-phase is energized. The optimal time to close the B-phase and C-phase breaker poles is simultaneously 90 degrees after A-phase. An additional one half cycle was added to align the times in the controller for a total close time of three quarter cycles after A phase. The voltage across the A-phase contacts approaches 1 p. u. just before they touch mechanically, and the voltage across the B-phase and C-phase contacts approaches 0.87 per unit just before they mechanically close. A 2 ms delay was added to the A-phase close time setting and a 1.5 ms delay was added to the B-phase and C-phase close time settings to account for prestriking of the breaker contacts.

The controlled tripping was set similar to the example just given. Fig. 22 and Fig. 23 show an uncontrolled and a controlled energization of the 500 kV transformer. The first energization attempt was performed with controller timers set at their initial preset values without considering the independent breaker pole closing time error. The second test

was performed with controller closing timer adjusted for the independent pole breaker close timing errors measured from the first energization test, which eliminated transformer inrush current.

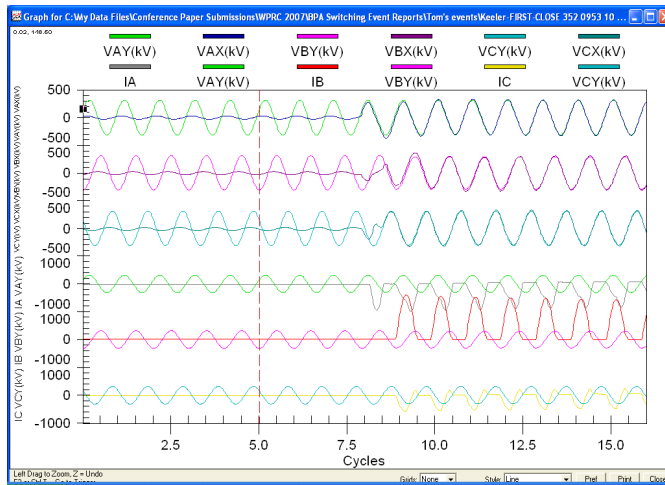

Fig. 22. Transformer closing with initial controller settings having substantial inrush current

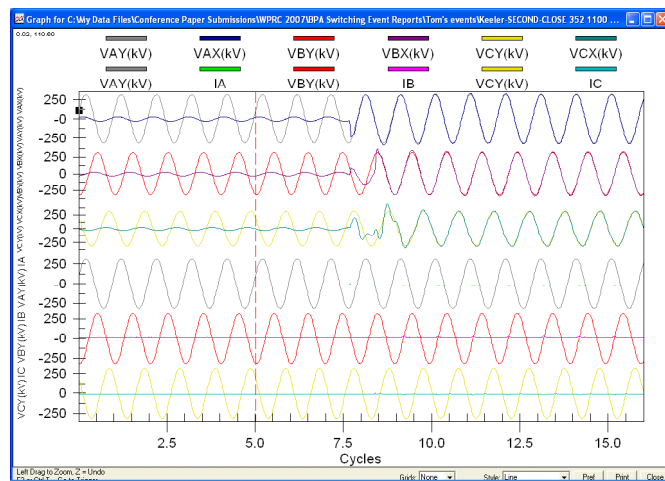

Fig. 23. Controlled transformer energization eliminates inrush current

B. Commissioning and Testing Requirements

Waveform recorders are very useful for commissioning controlled switching devices. Waveform recorders allow the user to compare the phase current switching times to the reference voltages, measure the time errors of the breaker poles, and if necessary, determine corrections for the timers. The oscillographic record also provides a good record of the effectiveness of controlled switching. This record shows, for example, whether inrush is reduced, or dc offset is eliminated.

Commissioning of controlled closing and controlled opening devices is done by performing in-service switching operations, measuring the time error in the breaker poles, and adjusting the controller logic timers. Some controllers are adaptive and adjust their internal times as the breaker operates, while others do not. Generally, it is better to time the breaker in advance and preset the timers for the controlled closing and controlled opening logic prior to the final commissioning tests. This can save needless operations of the breaker.

Adaptive devices in particular could require quite a few operations to adjust their times if they are not preset prior to commissioning. The BPA dispatchers generally do not allow for more than a few switching operations on power transformers, so it is important to make the corrections with as few operations as possible. A minimum of one switching event is required to measure the errors in the operating times of the breaker poles and make timing corrections. A second switching event should be performed to confirm the times and to make any final adjustments.

The operating times of power circuit breakers of a similar type from the same manufacturer are very consistent. Good timing data from one breaker can be used to preset the control logic timers in the controllers for other breakers of the same type. This can save considerable time by eliminating additional, redundant breaker timing tests. Newer breakers also have very repeatable operating times. Open and close controller timers can be set and adjusted in two or three switching events.

V. CONCLUSIONS

1. Uncontrolled switching of shunt capacitors, shunt reactors, transmission lines, and transformers creates electrical transients that may cause equipment failures, power quality problems, and protective relay misoperations.
2. Recent improvements in controlled switching technology have produced a variety of control devices that are capable of very precise breaker timing control for switching a wide variety of reactive power system loads.
3. The effectiveness of controlled switching depends on several factors, the most important of which is the circuit breaker operating time consistency. Breakers with a deviation in operating times (i.e., statistical scatter) of less than ± 1 ms and with steep RDDS are best suited for controlled switching applications.
4. Breakers in ring and breaker-and-a-half configurations may have to perform switching of different types of loads. This requires flexible controllers with different point-on-wave closing or opening sequences and capability to automatically switch operating parameters to match the system switching requirements.
5. Controlled switching benefits are immediate and long lasting. As control switching technology matures, the flexibility, reliability, ease-of-use, and overall cost of implementing controlled switching of breakers will improve, benefiting a larger portion of the power system.
6. Bonneville Power Administration has been actively pursuing controlled switching in their 500 kV system and selective 230 kV applications for more than a decade to reduce system transients, improve power quality, and increase the life expectancy of power system assets.

VI. REFERENCES

- [1] CIGRE WG 13.07, "Controlled Switching of HVAC Circuit-Breakers; Guide for Application," Part 1: ELECTRA, No 183, pp 43-73, April 1999, Part 2: ELECTRA, No 185, pp. 37-57, August 1999.
- [2] H. Ito, "Controlled switching technologies, state-of-the-art," Transmission and Distribution Conference and Exhibition 2002: Asia Pacific. IEEE/PES, vol. 2, pp. 1455-1460, 2002.
- [3] CIGRE TF 13.00.1, "Controlled Switching a State of the Art Survey," Part 1: ELECTRA, No 162, pp. 65-97, October 1995. Part 2: ELECTRA, No 164, pp. 39-61, February 1996.
- [4] CIGRE WG 13.04, "Capacitive Current Switching – State of the Art," ELECTRA, No 155, pp. 33-63, August 1994.
- [5] J. H. Brunke and K. J. Fröhlich, "Elimination of Transformer Inrush Currents by Controlled Switching, Part I," *IEEE Transactions on Power Delivery*, vol. 16, no 2, pp. 276-280, Apr. 2002.
- [6] J. H. Brunke and K. J. Fröhlich, "Elimination of Transformer Inrush Currents by Controlled Switching, Part II," *IEEE Transactions on Power Delivery*, Vol. 16, no 2, pp. 281-285, Apr. 2002.
- [7] J. H. Brunke and K. J. Fröhlich, "Elimination of Transformer Inrush Currents by Controlled Switching," *IEEE Electric Power Systems Research-Selected Topics in Power System Transients*, pp. 642-649, May 2006.
- [8] G. Moraw et al., "Point-On-Wave Controlled Switching of High Voltage Circuit-Breakers," Paper No. 13-02, Cigre 1988 Session, Paris, France.
- [9] K. Kamei and H. Kohyama, "Field Experience of Controlled Switching System Used for Transformer Switching," Mitsubishi Electric Advance, Vol. 117, pp18-21, March 2007.
- [10] P. Stroica, "Modern Methods for Synchronous Switching of Circuit Breakers in 400kV Substations of the Romanian Power System," *10th Mediterranean Elerotechnical Conference*, vol. III, pp. 949-952, 2000.
- [11] R. J. Rajotte, C. Charpentier, S. Breault, H. H. Le, H. Huynh, and J. Desmarais, "Field Test of A Circuit Breaker Synchronous Control," *IEEE Transactions on Power Delivery*, vol. 10, no 3, July 1995.
- [12] A. Mercier, E. Portales, Y. Filion, and A. Salibi, "Transformer control switching taking into account the core residual flux – a real case study," Paper No. 13-201, Cigre 2002 Session, Paris, France.
- [13] CIGRE WG 13.07, Controlled Switching of HVAC Circuit Breakers-Planning, Specification and Testing of Controlled Switching Systems, ELECTRA, No 197, pp. 23-33, August 2001.
- [14] CIGRE WG 13.07, Controlled Switching of Unloaded power Transformers, ELECTRA, No 212, pp. 39-47, February 2004.
- [15] CIGRE WG 13.07, Controlled Switching of HVAC Circuit Breakers – Benefits and Economic Aspects, ELECTRA, No 217, pp. 37-47, December 2004.
- [16] M. Steuer and K. Fröhlich, "The impact of inrush currents on the mechanical stress of high voltage power transformer coils," *IEEE Transactions on Power Delivery*, vol. 17, no 1, pp. 155-160, Jan. 2002.
- [17] E. Portales and Q. Bui-Van, "New control strategy of inrush transient during transformer energization at Toulmoustouc hydropower plant using a double break 330-kV circuit breakers," *International Conference on Power System Transients*, New Orleans, USA, 2003.
- [18] S. M. Wong, L. A. Snider, and E. W. C. Lo, "Overvoltages and reignition behavior of vacuum circuit breaker," *International Conference on Power System Transients*, New Orleans, USA, 2003.
- [19] C. D. Tsirekis and N. D. Hatzargyriou, "Control of Shunt Capacitors and Shunt Reactors Energization Transients" *International Conference on Power System Transients*, New Orleans, USA, 2003.
- [20] K. Fröhlich, C. Hoelzl, M. Stanek, A. C. Carvalho, W. Hofbauer, P. Hoegg, B. L. Avent, D. F. Peelo, and J. H. Sawada, "Controlled Closing on Shunt Compensated Transmission Lines. Part I: Closing Control Device Development. Part II: Application of Closing Control Device for High-Speed Autoreclosing on BC Hydro 500 kV Transmission Line." *IEEE Transactions on Power Delivery*, Vol. 12, No. 2, pp. 734-746, April 1997.
- [21] M. H. B. de Grijp and R.A. Hopkins, "Controlled Switching of Shunt Capacitors," *IEEE AFRICON, 4th Africon Conference in Africa*, Vol. 2, pp. 874-879, Sept. 1996.

- [22] Y. Filion, A. Coutou, and R. Isbister, "Experience with controlled switching systems (CSS) used for shunt capacitor banks: planning, studies and testing accordingly with CIGRE A3-07 working group guidelines," CIGRE/IEEE PES International Symposium on Quality and Security of Electric Power Delivery Systems, 2003.

VII. BIOGRAPHIES

Demetrios A. Tziouvaras has a B.S. and M.S. in Electrical Engineering from the University of New Mexico and Santa Clara University, respectively. He is an IEEE Senior member and a member of the Power Engineering Society, the Power System Relaying Committee, and CIGRE. From 1980 until 1998 he was with Pacific Gas and Electric Co., where he held various protection engineering positions including Principal Protection Engineer responsible for relay settings, analysis of relay operations and system disturbances, protection design standards, application of new technologies, and substation automation. He joined Schweitzer Engineering Laboratories, Inc. in 1998 and currently holds the position of Senior Research Engineer. His main interests are protection of power systems, power system transients, and digital relaying. He holds three patents and has several pending in the area of power system protection. He is the author and co-author of more than 30 IEEE and Protective Relay Conference papers. Currently, he is the convener of CIGRE WG B5.15 on "Modern Distance Protection Functions and Applications" and a member of several IEEE PSRC and CIGRE working groups.

Jeff Pope is the Lead Product Engineer for the Transmission Product Group at Schweitzer Engineering Laboratories, Inc. (SEL). Jeff is a member of the IEEE Power Engineering Society, and has been involved with the commissioning, control, protection, monitoring and automation of power system apparatus for 20 years. Jeff received his BSEET in 1986 from the DeVry Institute of Technology and a Master of Engineering from University of Wisconsin-Madison in 2005.

Dan Goldsworthy was born in Butte, Montana, in 1955. He graduated from Montana State University in 1980 with a M. S. in Electrical Engineering and joined Bonneville Power Administration that same year. Since 1981 he has been specializing in EMTP simulation, waveform analysis, and field testing at BPA.

Tom Roseburg received a BSEE from Washington State University in 1971. He began his career with Bonneville Power Administration in 1972 as a field engineer in the Branch of Substation Construction. In 1975 he became a field engineer in system protection maintenance working in substations at various locations in the states of Washington and Idaho. In 1988 he transferred to BPA's Branch of System Protection Maintenance in Vancouver, Washington. His main duties currently involve system protection issues on 115 kV, 230 kV, and 500 kV transmission systems.

[BACK TO THE TABLE OF CONTENTS](#)